

PR
electronics



5 3 3 4

**Transmetteur 2-fils
universel (TC)**

No 5334V108-FR

A partir du no de série 141365001



Revision Notes

The following list provides notes concerning revisions of this document.

Rev. ID	Date	Notes
108	13/45	IECEX and INMETRO approvals added

TRANSMETTEUR 2-FILS UNIVERSEL (TC)

PRETOP 5334

SOMMAIRE

Application.....	2
Caractéristiques techniques.....	2
Montage / installation.....	2
Applications.....	3
Référence: 5334.....	4
Spécifications.....	4
Connexions.....	7
Schéma de principe.....	8
Programmation.....	9
Dimensions mécaniques.....	10
Montage des fils du capteur.....	10
Appendix.....	11
ATEX Installation Drawing - 5334A.....	12
ATEX Installation Drawing - 5334B.....	13
IECEX Installation Drawing - 5334A.....	15
IECEX Installation Drawing - 5334B.....	16
INMETRO Instruções de Segurança - 5334A.....	18
INMETRO Instruções de Segurança - 5334B.....	19

TRANSMETTEUR 2-FILS UNIVERSEL (TC) PRETOP 5334

- *Entrée TC*
- *Grande précision de mesure*
- *Isolation galvanique*
- *Sécurité programmable*
- *Pour tête de sonde DIN B*

Application

- Mesure linéarisée de la température avec un capteur de thermocouples.
- Amplification des signaux mV bipolaires en un signal standard de 4...20 mA, éventuellement linéarisé suivant une fonction de linéarisation.

Caractéristiques techniques

- Le PR5334 peut être programmé de manière simple et rapide.
- La compensation de soudure froide (CSF) est réalisée à l'aide d'un capteur de température intégré au module.
- Vérification continue des données sauvegardées.

Montage / installation

- Pour tête de sonde DIN B. En zone non-dangereuse le 5334 peut être monté sur rail DIN avec le support PR type 8421.
- **N.B.** : Comme barrière S.I. pour le 5334B nous recommandons le PR5104B, 5114B ou 5116B.

APPLICATIONS

TC en 4...20 mA

Installation 2-fils
en salle de contrôle

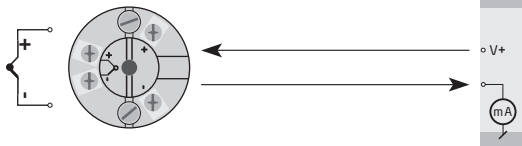

mV en 4...20 mA

Installation 2-fils
en salle de contrôle

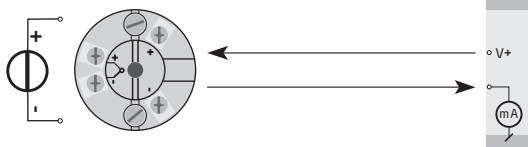

Référence : 5334

Type	Version	Température ambiante	Isolation galvanique
5334	Standard : A ATEX Ex, IECEx & INMETRO : B	-40°C...+85°C : 3	1500 Vca : B

Spécifications

Plage de température :

-40°C à +85°C

Spécifications communes :

Tension d'alimentation, cc

Standard..... 7,2...35 V

ATEX Ex, IECEx & INMETRO 7,2...30 Vcc

Consommation interne 25 mW...0,8 W

Chute de tension 7,2 Vcc

Tension d'isolation, test / opération 1,5 kVca / 50 Vca

Temps de chauffe..... 5 min.

Kit de programmation Loop Link

Rapport signal / bruit..... Min. 60 dB

Temps de réponse (programmable)..... 1...60 s

Vérification de l'EEPROM..... < 3,5 s

Dynamique du signal d'entrée..... 18 bit

Dynamique du signal de sortie..... 16 bit

Température d'étalonnage..... 20...28°C

Précision, la plus grande des valeurs générales et de base :

Valeurs générales		
Type d'entrée	Précision absolue	Coefficient de température
Tous	≤ ±0,05% de l'EC	≤ ±0,01% de l'EC / °C

Valeurs de base		
Type d'entrée	Précision de base	Coefficient de température
Volt	$\leq \pm 10 \mu V$	$\leq \pm 1 \mu V / ^\circ C$
Type TC: E, J, K, L, N, T, U	$\leq \pm 1^\circ C$	$\leq \pm 0,05^\circ C / ^\circ C$
Type TC: B, R, S, W3, W5, LR	$\leq \pm 2^\circ C$	$\leq \pm 0,2^\circ C / ^\circ C$

Immunité CEM	$< \pm 0,5\%$ de l'EC
Immunité CEM améliorée :	
NAMUR NE 21, critère A, burst	$< \pm 1\%$ de l'EC

Effet d'une variation de

la tension d'alimentation..... $< 0,005\%$ de l'EC / Vcc

Vibration..... IEC 60068-2-6 Test FC

Lloyd, spécification no 1..... 4 g / 2...100 Hz

Taille max. des fils..... 1 x 1,5 mm² fil multibrins

Pression max. avant déformation de la vis.... 0,4 Nm

Humidité..... $< 95\%$ HR (sans cond.)

Dimensions..... $\varnothing 44 \times 20,2$ mm

Degré de protection (boîtier / bornier)..... IP68 / IP00

Poids 50 g

Spécifications électriques, entrée:

Décalage max..... 50% de la valeur max. sélec.

Entrée TC:

Type	Température min.	Température max.	Plage min.	Standard
B	+400°C	+1820°C	100°C	IEC584
E	-100°C	+1000°C	50°C	IEC584
J	-100°C	+1200°C	50°C	IEC584
K	-180°C	+1372°C	50°C	IEC584
L	-100°C	+900°C	50°C	DIN 43710
N	-180°C	+1300°C	50°C	IEC584
R	-50°C	+1760°C	100°C	IEC584
S	-50°C	+1760°C	100°C	IEC584
T	-200°C	+400°C	50°C	IEC584
U	-200°C	+600°C	50°C	DIN 43710
W3	0°C	+2300°C	100°C	ASTM E988-90
W5	0°C	+2300°C	100°C	ASTM E988-90
LR	-200°C	+800°C	50°C	GOST 3044-84

Compensation de soudure froide.....	< ±1,0°C
Détection de rupture de sonde.....	Oui
Courant de sonde :	
Pendant la détection	Nom. 33 mA
Si non	0 mA

Entrée tension :

Gamme de mesure.....	-12...150 mV
Plage de mesure min.....	5 mV
Résistance d'entrée	10 MΩ

Sortie :

Sortie courant :

Gamme de mesure.....	4...20 mA
Plage de mesure min.....	16 mA
Temps de scrutation.....	440 ms
Sortie en cas de corruption de l'EEProm.....	≤ 3,5 mA
Résistance de charge.....	≤ (V _{alim.} - 7,2) / 0,023 [Ω]
Stabilité de charge.....	< ±0,01% de l'EC / 100 Ω

Détection de rupture de sonde :

Programmable	3,5...23 mA
NAMUR NE43 Haut d'échelle.....	23 mA
NAMUR NE43 Bas d'échelle	3,5 mA

EC = Echelle configurée

Approbations :

CEM 2004/108/CE	EN 61326-1
GOST R	

Approbation marine :

Det Norske Veritas, Ships & Offshore	Standard for Certification No. 2.4
--	------------------------------------

Ex:

ATEX 94/9/CE	
5334A.....	KEMA 10ATEX0002 X
5334B.....	KEMA 06ATEX0062 X
IECEX	DEK 13.0035X
INMETRO	DEKRA 13.0001 X
GOST Ex	

CONNEXIONS

Entrée :

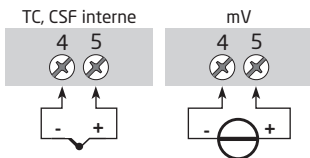

Sortie :

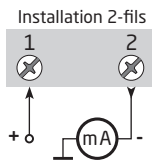

SCHEMA DE PRINCIPE

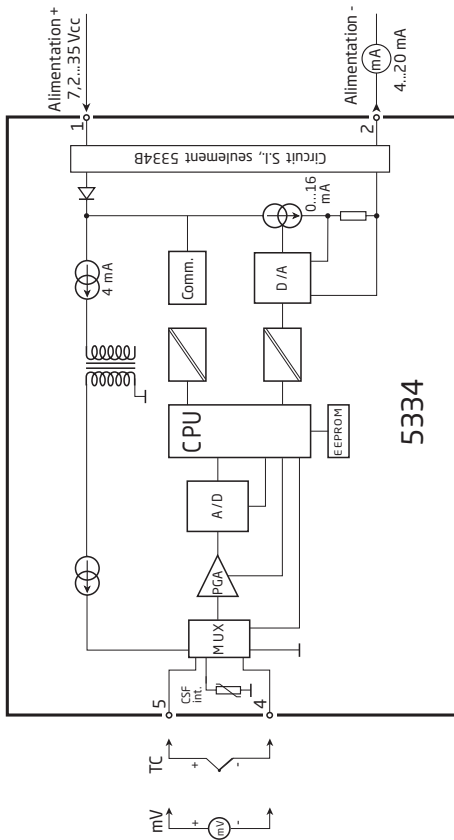

PROGRAMMATION

- Loop Link est un kit de programmation permettant de programmer le PRetop 5334.
- Pour le raccordement du Loop Link, veuillez vous reporter au schéma ci-dessous et à l'aide en ligne du logiciel PRreset.
- Loop Link ne doit pas être utilisé pour communication avec des modules installés en zone dangereuse.

Numéro de référence : Loop Link

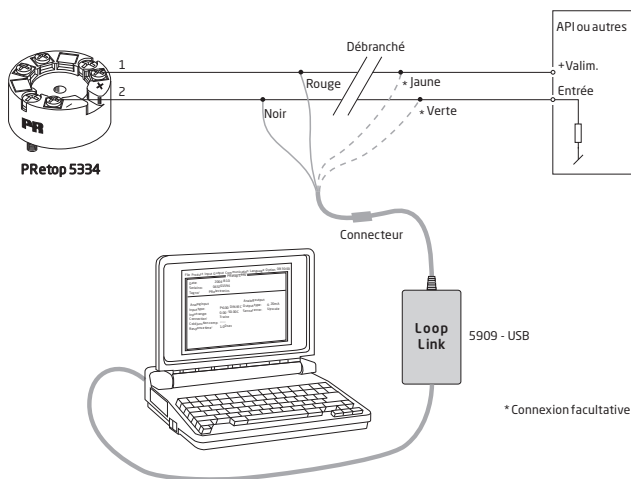

Dimensions mécaniques

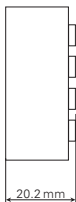
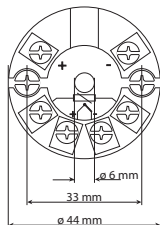

Montage des fils du capteur

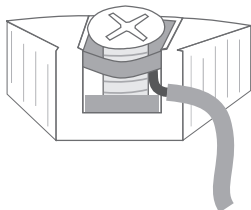

Les fils doivent être montés entre les plaques métalliques.

APPENDIX

ATEX INSTALLATION DRAWING - 5334A

ATEX INSTALLATION DRAWING - 5334B

IECE_x INSTALLATION DRAWING - 5334A

IECE_x INSTALLATION DRAWING - 5334B

INMETRO INSTRUÇÕES DE SEGURANÇA - 5334A

INMETRO INSTRUÇÕES DE SEGURANÇA - 5334B

Schéma d'installation ATEX

Pour une installation sûre du 5331A3B ou du 5334A3B vous devez observer ce qui suit. Le module sera seulement installé par un personnel qualifié qui est informé des lois, des directives et des normes nationales et internationales qui s'appliquent à ce secteur.
L'année de la fabrication est indiquée dans les deux premiers chiffres dans le numéro de série.

Certificat ATEX KEMA 10ATEX 0002 X

Marquage  II 3 G Ex nA [ic] IIC T4 ... T6 Gc
II 3 G Ex ic IIC T4...T6 Gc
II 3 D Ex ic IIC Dc

Standards EN 60079-0 : 2012, EN 60079-11 : 2012, EN 60079-15 : 2010

T4: $-40 \leq T_a \leq 85^\circ\text{C}$ T6: $-40 \leq T_a \leq 60^\circ\text{C}$	Bornes : 3,4,5,6 Ex nA [ic]	Bornes : 1,2 Ex nA	Bornes : 1,2 Ex ic
	Uo: 9,6 V Io: 25 mA Po: 60 mW Lo: 33 mH Co: 2,4 μF	Umax. $\leq 35 \text{ Vcc}$	Uj = 35 Vcc Ii = 110 mA Li = 10 μH Ci = 1,0 nF

Conditions spécifiques à l'utilisation sûre :

Pour le type de protection Ex nA, le transmetteur doit être installé dans un boîtier de protection assurant un degré d'étanchéité d'au moins IP54 conformément à l'EN 60529.

Pour utilisation dans la présence de poussières combustibles, le transmetteur doit être installé dans un boîtier de protection assurant un degré d'étanchéité d'au moins IP6X conformément à l'EN 60529. La température de surface du boîtier doit être déterminée après l'installation des unités. La température de surface du boîtier est de 20 K au dessus de la température ambiante.

Pour une température ambiante $\geq 60^\circ\text{C}$, il faut utiliser des câbles résistant aux températures élevées avec une capacité nominale d'au moins 20 K au dessus de la température ambiante.

Schéma d'installation ATEX



Pour une installation sûre du 5331D ou 5334B vous devez observer ce qui suit. Le module sera seulement installé par un personnel qualifié qui est informé des lois, des directives et des normes nationales et internationales qui s'appliquent à ce secteur.

L'année de la fabrication est indiquée dans les deux premiers chiffres dans le numéro de série.

Certificat ATEX KEMA 06ATEX 0062 X

Marquage  II 1 G Ex ia IIC T4...T6 Ga
II 1 D Ex ia IIIC Da
II 1 M Ex ia I Ma

Standards EN 60079-0 : 2012, EN 60079-11 : 2012, EN 60079-26 : 2007,
EN 60079-15 :2010

Zone dangereuse

Zone 0, 1, 2, 20, 21, 22

T4: $-40 \leq T_a \leq 85^\circ\text{C}$

T6: $-40 \leq T_a \leq 60^\circ\text{C}$

Bornes : 3,4,5,6

Uo: 9,6 Vcc

Io: 25 mA

Po: 60 mW

Lo: 33 mH

Co: 2,4µF

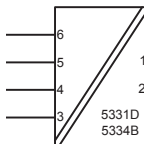

Bornes : 1,2

Ui: 30 Vcc

Ii: 120 mA

Pi: 0,84 W

Li: 10µH

Ci: 1,0nF

Zone non dangereuse

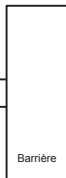

Notes d'installation

L'isolation galvanique entre le circuit du capteur et le circuit d'entrée n'est pas infaillible. Cependant, l'isolation galvanique entre les circuits est capable de résister à une tension de test de 500 Vca pendant 1 minute.

Dans les atmosphères potentiellement explosibles dû à la présence de gaz, le transmetteur doit être installé dans un boîtier de protection assurant un degré d'étanchéité d'au moins IP20 conformément à l'EN 60529.

Pour les installations dans les atmosphères explosibles exigeant des appareils de catégorie 1 G, 1 M ou 2 M, et dans le cas où le boîtier est fait d'aluminium, le boîtier doit être installé dans une telle manière que, même dans le cas d'incidents rares, les sources d'inflammation dues aux impacts et aux étincelles de friction ne peuvent se produire; dans le cas où le boîtier est fait de matériaux non métalliques, les décharges électrostatiques sur le boîtier du transmetteur doivent être évitées.

Pour les installations dans les atmosphères potentiellement explosibles dû à la présence de poussières combustibles on doit observer ce qui suit :

Le transmetteur monté dans un boîtier métallique DIN B conformément à DIN 43729. Ce boîtier doit assurer un degré d'étanchéité d'au moins IP 6X conformément à l'EN 60529 et il doit convenir à l'application et être correctement installé.

Seulement des raccords de câble et des bouchons convenant à l'application et correctement installés doivent être utilisés.

Pour une température ambiante $\geq 60^{\circ}\text{C}$, il faut utiliser des câbles résistant aux températures élevées avec une capacité nominale d'au moins 20 K au dessus de la température ambiante.

La température superficielle du boîtier égale la température ambiante plus 20K, pour une couche de poussière d'une épaisseur jusqu'à 5 mm.

IECEx Installation drawing



For safe installation of 5331A or 5334A the following must be observed. The module shall only be installed by qualified personnel who are familiar with the national and international laws, directives and standards that apply to this area.

Year of manufacture can be taken from the first two digits in the serial number.

Certificate	IECEx DEK 13.0035X		
Marking	Ex nA [ic] IIC T4..T6 Gc Ex ic IIC T4..T6 Gc Ex ic IIIC Dc		
Standards	IEC 60079-0 : 2011, IEC 60079-11 : 2011, IEC 60079-15 : 2010		

T4: $-40 \leq T_a \leq 85^\circ\text{C}$
T6: $-40 \leq T_a \leq 60^\circ\text{C}$

Terminal: 3,4,5,6

U_o: 9.6 V
I_o: 25 mA
P_o: 60 mW
L_o: 33 mH
C_o: 2.4 μF

Terminal: 1,2

Ex nA
U_{max} = 35 VDC

Terminal: 1,2

Ex ic
U_i = 35 VDC
I_i = 110 mA
L_i = 10 μH
C_i = 1.0 nF

Installation note:

For installation in a potentially explosive gas atmosphere, the following instructions apply:

For nA installation the transmitter must be installed in an metal enclosure, e.g. a form B enclosure providing a degree of protection of at least IP54 according to IEC60529 or in an enclosure with type of protection Ex n or Ex e.

For ic installation the transmitter must be installed in enclosure providing a degree of protection of at least IP20 according to IEC60529 and that is suitable for the application.

Cable entry devices and blanking elements shall fulfill the same requirements

For an ambient temperature $\geq 60^\circ\text{C}$, heat resistant cables shall be used with a rating of at least 20 K above the ambient temperature.

For installation in a potentially explosive dust atmosphere, the following instructions apply:

The surface temperature of the enclosure is equal to the ambient temperature plus 20 K, for a dust layer with a thickness up to 5 mm.

The transmitter must be mounted in a enclosure according to DIN 43729 that provides a degree of protection of at least IP6X according to IEC60529, and that is suitable for the application. Cable entry devices and blanking elements shall fulfill the same requirements.

IECEx Installation drawing



For safe installation of 5331D or 5334B the following must be observed. The module shall only be installed by qualified personnel who are familiar with the national and international laws, directives and standards that apply to this area.

Year of manufacture can be taken from the first two digits in the serial number.

Certificate	IECEx DEK 13.0035X
Marking	Ex ia IIC T4...T6 Ga Ex ia IIIC Da Ex ia I Ma
Standards	IEC 60079-0 : 2011, IEC 60079-11 : 2011, IEC 60079-26:2006

Hazardous area

Zone 0, 1, 2, 20, 21, 22, M1

T4: $-40 \leq T_a \leq 85^\circ\text{C}$

T5: $-40 \leq T_a \leq 60^\circ\text{C}$

T6: $-40 \leq T_a \leq 45^\circ\text{C}$

Terminal: 3,4,5,6

Uo: 9.6 VDC

Io: 25 mA

Po: 60 mW

Lo: 33 mH

Co: 2.4 μF

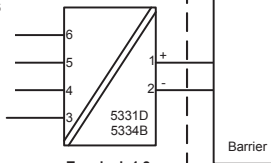

Terminal: 1,2

Ui: 30 VDC

Ii: 120 mA

Pi: 0.84 W

Li: 10 μH

Ci: 1.0 nF

Installation notes.

The sensor circuit is not infallibly galvanic isolated from the input circuit. However, the galvanic isolation between the circuits is capable of withstanding a test voltage of 500Vac during 1 minute.

In a potentially explosive gas atmosphere, the transmitter shall be mounted in a metal form B enclosure in order to provide a degree of protection of at least IP20 according to IEC60529. If however the environment requires a higher degree of protection, this shall be taken into account.

If the transmitter is installed in an explosive atmosphere requiring the use of equipment protection level Ga, Ma and Mb, and if the enclosure is made of aluminum, it must be installed such, that ignition sources due to impact and friction sparks are excluded.

For installation in a potentially explosive dust atmosphere, the following instructions apply:

For explosive dust atmospheres, the surface temperature of the outer enclosure is 20 K above the ambient temperature.

The transmitter shall be mounted in a metal enclosure form B according to DIN43729 that is providing a degree of protection of at least IP6X according to IEC60529, that is suitable for the application and correctly installed.

Cable entries and blanking elements shall be used that are suitable for the application and correctly installed.

For an ambient temperature $\geq 60^{\circ}\text{C}$, heat resistant cables shall be used with a rating of at least 20 K above the ambient temperature.

Desenho de Instalação INMETRO



Para instalação segura do 5331A ou 5334A o seguinte deve ser observado. O modo deve apenas ser instalado por pessoas qualificadas que são familiarizadas com as leis nacionais e internacionais, diretrizes e padrões que se aplicam a esta área.

Ano de fabricação pode ser pego dos dois primeiros dígitos do número de série.

Certificado	DEKRA 13.0001 X
Indicação	Ex nA [ic] IIC T4..T6 Gc Ex ic IIC T4..T6 Gc Ex ic IIIC Dc

Padrões ABNT NBR IEC 60079-0 : 2008, ABNT NBR IEC 60079-11 : 2009,
IEC 60079-15 : 2010, ABNT NBR IEC 60079-26 : 2008

T4: $-40 \leq T_a \leq 85^{\circ}\text{C}$	Terminal: 3,4,5,6	Terminal: 1,2	Terminal: 1,2
T6: $-40 \leq T_a \leq 60^{\circ}\text{C}$	Uo: 9,6 V	Ex nA	Ex ic
	Io: 25 mA		
	Po: 60 mW	Umax =35 VDC	Ui = 35 VDC
	Lo: 33 mH		Ii = 110 mA
	Co: 2,4 μF		Li = 10 μH
			Ci = 1,0 nF

Notas para instalação

Para a instalação em uma atmosfera de gás potencialmente explosivo, se aplicam as instruções a seguir:

Para a instalação nA o transmissor deve ser instalado em um gabinete de metal, por exemplo, gabinete em forma B que forneça um grau de proteção de pelo menos IP54 de acordo com IEC60529 ou em um caixa com tipo de proteção Ex n ou Ex e.

Para a instalação IC o transmissor deve ser instalado em um invólucro proporcionando um grau de proteção de IP20, pelo menos, de acordo com a norma IEC60529 que é adequado para a aplicação.

Dispositivos de entrada de cabos e elementos de supressão devem cumprir os mesmos requisitos.

Para uma temperatura ambiente $\geq 60^{\circ}\text{C}$, os cabos resistentes ao calor precisam ser utilizados com uma classificação de pelo menos 20 K acima da temperatura ambiente.

Para a instalação em uma atmosfera de poeira potencialmente explosiva, se aplicam as instruções a seguir:

A temperatura da superfície do invólucro é igual à temperatura ambiente mais 20 K, para uma camada de pó, com uma espessura superior a 5 mm.

O transmissor deve ser montado em um invólucro de acordo com a norma DIN 43729, que proporciona um grau de proteção de, pelo menos, IP6X de acordo com a norma IEC60529, e que seja apropriado para a aplicação.

Dispositivos de entrada de cabos e elementos de supressão devem cumprir as mesmas exigências.

Desenho de Instalação INMETRO



Para instalação segura do 5331D ou 5334B o seguinte deve ser observado. O modo deve apenas ser instalado por pessoas qualificadas que são familiarizadas com as leis nacionais e internacionais, diretrizes e padrões que se aplicam a esta área.
Ano de fabricação pode ser pego dos dois primeiros dígitos do número de série.

CertificadoDEKRA 13.0001 X

Indicação Ex ia IIC T6...T4 Ga
Ex ia IIIC Da

Padrões ABNT NBR IEC 60079-0 : 2008 ABNT NBR IEC 60079-11 : 2009 IEC 60079-15 : 2010
ABNT NBR IEC 60079-26 : 2008

Áreas Perigosas

Zona 0, 1, 2, 20, 21, 22,

T4: $-40 \leq T_a \leq 85^\circ\text{C}$

T5: $-40 \leq T_a \leq 60^\circ\text{C}$

T6: $-40 \leq T_a \leq 45^\circ\text{C}$

Terminal: 3,4,5,6

Uo: 9,6 VDC

Io: 25 mA

Po: 60 mW

Lo: 33 mH

Co: 2,4 μ F

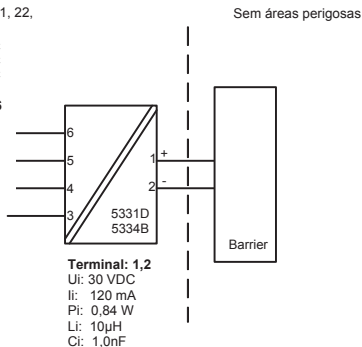

Notas de instalação

O circuito do sensor não é isolado galvanicamente infalível do circuito de entrada. Contudo, a isolação galvânica entre os circuitos é capaz de resistir a um teste de tensão de 500Vac durante 1 minuto.

Em uma atmosfera de gás potencialmente explosiva, o transmissor deve ser montado em um enclosure a fim de garantir um grau de proteção de no mínimo IP20 de acordo com EN60529. Se contudo o ambiente requer um nível de proteção maior, isso deve ser levado em conta

Se o transmissor é instalado em uma atmosfera explosiva exigindo o uso de equipamento de categoria Ga e se o enclosure é feito de alumínio, ele deve ser instalado de modo que, mesmo em caso de avaria rara, fontes de ignição devido a impacto e fricção, faíscas são eliminadas; se o enclosure é feito de materiais não metálicos, cargas eletroestáticas devem ser evitadas.

Para instalação em atmosfera de poeira potencialmente explosiva, as instruções a seguir:

O transmissor deve ser montado em enclosure de metal forma B de acordo com DIN43729 que está fornecendo um grau de proteção de pelo menos IP6X de acordo com EN60529. Isso é adequado para aplicação e corretamente instalado.

As entradas dos cabos e os elementos de obturação que podem ser utilizados são adequados para a aplicação e corretamente instalados.

Para temperatura ambiente $\geq 60^{\circ}\text{C}$, fios de resistência ao calor devem ser usados com uma faixa de pelo menos 20K acima da temperatura ambiente.

A temperatura da superfície do enclosure é igual à temperatura ambiente mais de 20 K, por uma camada de pó, com uma espessura até 5 mm.



Displays Programmable displays with a wide selection of inputs and outputs for display of temperature, volume and weight, etc. Feature linearisation, scaling, and difference measurement functions for programming via PReset software.



Ex interfaces Interfaces for analogue and digital signals as well as HART® signals between sensors / I/P converters / frequency signals and control systems in Ex zone 0, 1 & 2 and for some devices in zone 20, 21 & 22.



Isolation Galvanic isolators for analogue and digital signals as well as HART® signals. A wide product range with both loop-powered and universal isolators featuring linearisation, inversion, and scaling of output signals.



Temperature A wide selection of transmitters for DIN form B mounting and DIN rail devices with analogue and digital bus communication ranging from application-specific to universal transmitters.



Universal PC or front programmable devices with universal options for input, output and supply. This range offers a number of advanced features such as process calibration, linearisation and auto-diagnosis.





www.preelectronics.fr
sales@preelectronics.fr



www.preelectronics.de
sales@preelectronics.de



www.preelectronics.es
sales@preelectronics.es



www.preelectronics.it
sales@preelectronics.it



www.preelectronics.se
sales@preelectronics.se



www.preelectronics.com
sales@preelectronics.com



www.preelectronics.com
sales@preelectronics.com



www.preelectronics.cn
sales@preelectronics.cn

Head office

Denmark
PR electronics A/S
Lerbakken 10
DK-8410 Rønede

www.preelectronics.com
sales@preelectronics.dk
tel. +45 86 37 26 77
fax +45 86 37 30 85



QUALITY SYSTEM AND ENVIRONMENTAL MANAGEMENT SYSTEM
DS/EN ISO 9001
DS/EN ISO 14001

