

# PR



## 5 3 3 3

**2-Wire Programmable  
Transmitter**

No. 5333V110-UK  
From ser. no. 080629052



**ATEX**



**SIGNALS THE BEST**

- DK** ▶ PR electronics A/S tilbyder et bredt program af analoge og digitale signalbehandlingsmoduler til industriel automation. Programmet består af Isolatorer, Displays, Ex-barrierer, Temperaturtransmittere, Universaltransmittere mfl. Vi har modulerne, du kan stole på i selv barske miljøer med elektrisk støj, vibrationer og temperaturudsving, og alle produkter opfylder de strengeste internationale standarder. Vores motto »Signals the Best« er indbegrebet af denne filosofi – og din garanti for kvalitet.
- UK** ▶ PR electronics A/S offers a wide range of analogue and digital signal conditioning devices for industrial automation. The product range includes Isolators, Displays, Ex Interfaces, Temperature Transmitters, and Universal Devices. You can trust our products in the most extreme environments with electrical noise, vibrations and temperature fluctuations, and all products comply with the most exacting international standards. »Signals the Best« is the epitome of our philosophy – and your guarantee for quality.
- FR** ▶ PR electronics A/S offre une large gamme de produits pour le traitement des signaux analogiques et numériques dans tous les domaines industriels. La gamme de produits s'étend des transmetteurs de température aux afficheurs, des isolateurs aux interfaces SI, jusqu'aux modules universels. Vous pouvez compter sur nos produits même dans les conditions d'utilisation sévères, p.ex. bruit électrique, vibrations et fluctuations de température. Tous nos produits sont conformes aux normes internationales les plus strictes. Notre devise »SIGNALS the BEST« c'est notre ligne de conduite - et pour vous l'assurance de la meilleure qualité.
- DE** ▶ PR electronics A/S verfügt über ein breites Produktprogramm an analogen und digitalen Signalverarbeitungsmodulen für die industrielle Automatisierung. Dieses Programm umfasst Displays, Temperaturtransmitter, Ex- und galvanische Signaltrenner, und Universalgeräte. Sie können unsere Geräte auch unter extremen Einsatzbedingungen wie elektrisches Rauschen, Erschütterungen und Temperaturschwingungen vertrauen, und alle Produkte von PR electronics werden in Übereinstimmung mit den strengsten internationalen Normen produziert. »Signals the Best« ist Ihre Garantie für Qualität!

# 2-WIRE PROGRAMMABLE TRANSMITTER

## PRetop 5333

### Contents

EC declaration of conformity .....	2
Application .....	3
Technical characteristics .....	3
Mounting / installation.....	3
Applications.....	4
Order: 5333 .....	5
Electrical specifications.....	5
Connections .....	8
Block diagram .....	9
Programming.....	10
Mechanical specifications .....	11
Mounting of sensor wires.....	11
Appendix .....	12
ATEX Installation Drawing - 5333A.....	13
ATEX Installation Drawing - 5333D .....	14
FM Installation Drawing 5300Q532 .....	16
CSA Installation Drawing 533XQC03 .....	18

# EC DECLARATION OF CONFORMITY

As manufacturer

**PR electronics A/S**  
**Lerbakken 10**  
**DK-8410 Rønde**

hererby declares that the following product:

**Type: 5333**  
**Name: 2-Wire programmable transmitter**

is in conformity with the following directives and standards:

The EMC Directive 2004/108/EC and later amendments  
**EN 61326-1 : 2006**

For specification of the acceptable EMC performance level, refer to the electrical specifications for the module.

The ATEX Directive 94/9/EC and later amendments

**EN 60079-0 : 2006, EN 60079-11 : 2007,**  
**EN 60079-15 : 2005 and EN 60079-26 : 2007**  
**EN 61241-0 : 2006 and EN 61241-11 : 2006**  
**ATEX certificate: KEMA 10ATEX0003 X (5333A)**  
**ATEX certificate: KEMA 03ATEX1535 (5333D)**

No changes are required to enable compliance with the replacement standards:

**EN 60079-0 : 2009 and EN 60079-11 : 2012**

Notified body

**KEMA Quality B.V. (0344)**  
**Utrechtseweg 310, 6812 AR Arnhem**  
**P.O. Box 5185, 6802 ED Arnhem**  
**The Netherlands**

Rønde, 24 September 2012



Kim Rasmussen  
Manufacturer's signature

## 2-WIRE PROGRAMMABLE TRANSMITTER PRetop 5333

- *RTD or Ohm input*
- *High measurement accuracy*
- *3-wire connection*
- *Programmable sensor error value*
- *For DIN form B sensor head mounting*

### Application

- Linearised temperature measurement with Pt100...Pt1000 or Ni100...Ni1000 sensor.
- Conversion of linear resistance variation to a standard analogue current signal, for instance from valves or Ohmic level sensors.

### Technical characteristics

- Within a few seconds the user can program PR5333 to measure temperatures within all RTD ranges defined by the norms.
- The RTD and resistance inputs have cable compensation for 3-wire connection.

### Mounting / installation

- For DIN form B sensor head mounting. In non-hazardous areas the 5333 can be mounted on a DIN rail with a special fitting.
- **NB:** As Ex barrier for 5333D we recommend 5104B, 5114B, or 5116B.

## APPLICATIONS

RTD to 4...20 mA

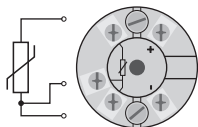

2-wire installation  
in control room

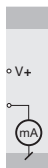

Resistance to 4...20 mA

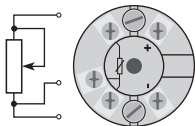

2-wire installation  
in control room

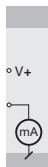

Order: 5333

Type	Version
5333	Standard : A CSA, FM & ATEX : D

## Electrical specifications

### Specifications range:

-40°C to +85°C

### Common specifications:

Supply voltage, DC

Standard..... 8...35 V

CSA, FM & ATEX..... 8...30 V

Internal consumption ..... 25 mW...0.8 W

Voltage drop ..... 8 VDC

Warm-up time..... 5 min.

Communications interface ..... Loop Link

Signal / noise ratio ..... Min. 60 dB

Response time (programmable)..... 0.33...60 s

Signal dynamics, input..... 19 bit

Signal dynamics, output..... 16 bit

Calibration temperature..... 20...28°C

Accuracy, the greater of general and basic values:

General values		
Input type	Absolute accuracy	Temperature coefficient
All	$\leq \pm 0.1\%$ of span	$\leq \pm 0.01\%$ of span / °C

Basic values		
Input type	Basic accuracy	Temperature coefficient
RTD	$\leq \pm 0.3^\circ\text{C}$	$\leq \pm 0.01^\circ\text{C}/^\circ\text{C}$
Lin. R	$\leq \pm 0.2 \Omega$	$\leq \pm 20 \text{ m}\Omega / ^\circ\text{C}$

EMC immunity influence .....	$< \pm 0.5\%$ of span
------------------------------	-----------------------

Effect of supply voltage variation.....	≤ 0,005% of span / VDC
Vibration .....	IEC 60068-2-6 Test FC
Lloyd's specification no. 1.....	4 g / 2...100 Hz
Max. wire size.....	1 x 1.5 mm <sup>2</sup> stranded wire
Humidity .....	< 95% RH (non-cond.)
Dimensions.....	Ø 44 x 20.2 mm
Protection degree (enclosure / terminal).....	IP68 / IP00
Weight .....	50 g

### Electrical specifications, input:

#### RTD and linear resistance input:

RTD type	Min. value	Max. value	Min. span	Standard
Pt100	-200°C	+850°C	25°C	IEC 60751
Ni100	-60°C	+250°C	25°C	DIN 43760
Lin. R	0 Ω	10000 Ω	30 Ω	-----

Max. offset.....	50% of selec. max. value
Cable resistance per wire (max.).....	10 Ω
Sensor current.....	> 0.2 mA, < 0.4 mA
Effect of sensor cable resistance (3-wire).....	< 0.002 Ω / Ω
Sensor error detection .....	Yes

#### Output:

##### Current output:

Signal range .....	4...20 mA
Min. signal range.....	16 mA
Updating time.....	135 ms
Load resistance .....	≤ (V <sub>supply</sub> - 8) / 0.023 [Ω]
Load stability .....	< ±0.01% of span / 100 Ω

##### Sensor error detection:

Programmable.....	3.5...23 mA
NAMUR NE43 Upscale .....	23 mA
NAMUR NE43 Downscale.....	3.5 mA

Of span = Of the presently selected range



**Ex approval - 5333A:**

KEMA 10ATEX0003 X.....	II 3 GD Ex nA [nL] IIC T4...T6 or II 3 GD Ex nL IIC T4...T6 or  II 3 GD Ex nA [ic] IIC T4...T6 or II 3 GD Ex ic IIC T4...T6
ATEX Installation Drawing No.....	5333QA02

**Ex / I.S. approval - 5333D:**

KEMA 03ATEX1535.....	 II 1 G Ex ia IIC T4 or T6 II 1 D Ex iaD
Max. amb. temperature for T4 .....	85°C
Max. amb. temperature for T6 .....	60°C
ATEX, applicable in zone.....	0, 1, 2, 20, 21 or 22
ATEX Installation Drawing No. ....	5333QA01
FM, applicable in.....	IS, Class I, Div. 1, Group A, B, C, D IS, Class I, Zone 0, AEx ia IIC
FM Installation Drawing No.....	5300Q502
CSA, applicable in.....	IS, Class I, Div. 1, Group A, B, C, D, Ex ia IIC IS, Class I, Zone 0, AEx ia IIC
CSA Installation Drawing No. ....	5333XQC03

**Marine approval:**

Det Norske Veritas, Ships & Offshore ..... Standard for Certification No. 2.4

**GOST R approval:**

VNIIM & VNIIFTRI, Cert. no. .... See [www.preelectronics.com](http://www.preelectronics.com)

**Observed authority requirements:**

EMC 2004/108/EC .....	EN 61326-1
ATEX 94/9/EC.....	EN 60079-0, EN 60079-11, EN 60079-15, EN 60079-26, EN 61241-0, EN 61241-11
FM .....	3600, 3611, 3610
CSA, CAN / CSA.....	C22.2 No. 157, E60079-11, UL 913

**Standard:**

# CONNECTIONS

## Input:

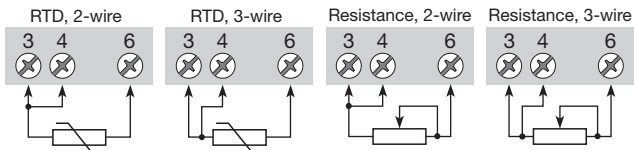

## Output:

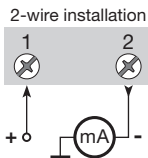

# BLOCK DIAGRAM

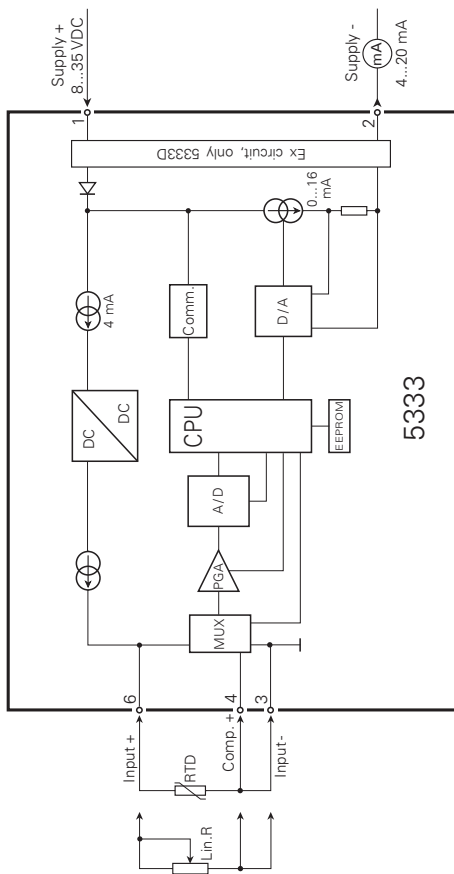

# PROGRAMMING

- Loop Link is a communications interface that is needed for programming PRetop 5333.
- For programming please refer to the drawing below and the help functions in PReset.
- Loop Link is not approved for communication with modules installed in hazardous (Ex) areas.

## Order: Loop Link

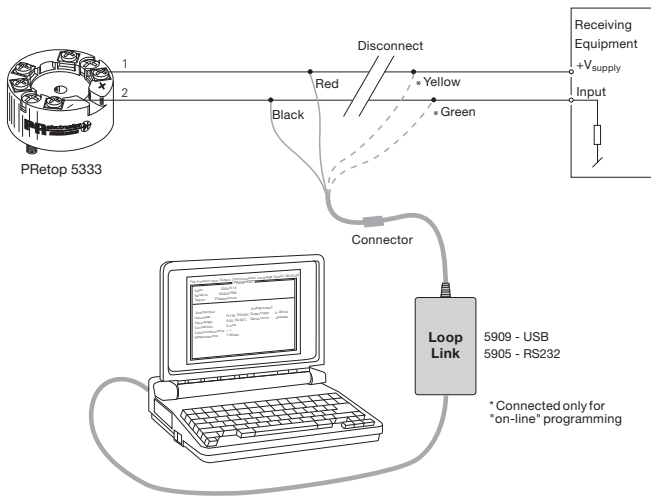

## Mechanical specifications

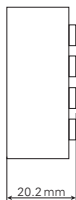
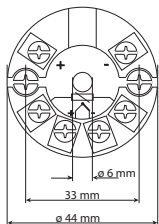

## Mounting of sensor wires

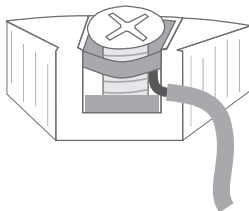

Wires must be mounted between the metal plates.

# APPENDIX

**ATEX Installation Drawing - 5333A**

**ATEX Installation Drawing - 5333D**

**FM Installation Drawing No. 5300Q502**

**CSA Installation Drawing No. 533XQC03**

## ATEX Installation drawing

For safe installation of 5333A the following must be observed. The module shall only be installed by qualified personnel who are familiar with the national and international laws, directives and standards that apply to this area.

Year of manufacture can be taken from the first two digits in the serial number.

ATEX Certificate      KEMA 10ATEX0003 X

Marking  II 3 GD Ex nA [nL] IIC T6...T4  
 II 3 GD Ex nL IIC T6...T4  
  
 II 3 GD Ex nA [ic] IIC T6...T4  
 II 3 GD Ex ic IIC T6...T4

Standards              EN 60079-0 : 2006, EN 60079-11 : 2007, EN 60079-15 : 2005

T4:  $-40 \leq T_a \leq 85^\circ\text{C}$   
 T6:  $-40 \leq T_a \leq 60^\circ\text{C}$

**Terminal: 3,4,6**  
 Ex nA [nL]

U<sub>o</sub>: 27 V  
 I<sub>o</sub>: 7.0 mA  
 P<sub>o</sub>: 45 mW  
 L<sub>o</sub>: 35 mH  
 C<sub>o</sub>: 90 nF

**Terminal: 1,2**  
 Ex nA

U ≤ 35 VDC  
 I = 4 - 20 mA

**Terminal: 1,2**  
 Ex nL or Ex ic

U<sub>i</sub> = 35 VDC  
 L<sub>i</sub> = 10 μH  
 C<sub>i</sub> = 1.0 nF

### Special conditions for safe use

For use in a potentially explosive atmosphere of flammable gasses, vapours or mists, the transmitter shall be mounted in an enclosure providing a degree of protection of at least IP54 in accordance to EN60529.

For use in the presence of combustible dusts the transmitter shall be mounted in an enclosure providing a degree of protection of at least IP6X in accordance with o EN60529. The surface temperature of the enclosure shall be determined after installation of the transmitter.

For an ambient temperature  $\geq 60^\circ\text{C}$ , heat resistant cables shall be used with a rating of at least 20 K above the ambient temperature.

## ATEX Installation drawing

**5333**

For safe installation of 5333D the following must be observed. The module shall only be installed by qualified personnel who are familiar with the national and international laws, directives and standards that apply to this area.

Year of manufacture can be taken from the first two digits in the serial number.

ATEX Certificate      KEMA 03ATEX 1535

Marking       II 1 G Ex ia IIC T6..T4  
 II 1 D Ex iaD

Standards      EN 60079-0 : 2006, EN 60079-11 : 2007, EN 60079-26 : 2007,  
 EN 61241-0 : 2006, EN 61241-11 : 2006

Hazardous area  
 Zone 0, 1, 2, 20, 21, 22

T4:  $-40 \leq T_a \leq 85^\circ\text{C}$  T105 °C

T6:  $-40 \leq T_a \leq 60^\circ\text{C}$  T80 °C

**Terminal: 3,4,6**

Uo: 27 VDC

Io: 7 mA

Po: 45 mW

Lo: 35 mH

Co: 90 nF

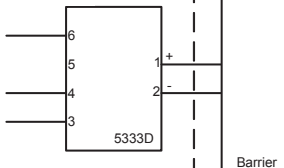
**Terminal: 1,2**

Ui: 30 VDC

Ii: 120 mA

Pi: 0.84 W

Li: 10µH

Ci: 1.0nF



**Installation notes:**

In a potentially explosive gas atmosphere, the transmitter shall be mounted in an enclosure in order to provide a degree of protection of at least IP20 according to EN60529.

If the transmitter is installed in an explosive atmosphere requiring the use of equipment of category 1G and if the enclosure is made of aluminium, it must be installed such, that even in the event of rare incidents, ignition sources due to impact and friction, sparks are excluded; if the enclosure is made of non-metallic materials, electrostatic charging shall be avoided.

For installation in a potentially explosive dust atmosphere, the following instructions apply:

The transmitter shall be mounted in a metal enclosure form B according to DIN43729 that is providing a degree of protection of at least IP6X according to EN60529 that is suitable for the application and correctly installed.

Cable entries and blanking elements shall be used that are suitable for the application and correctly installed.

For an ambient temperature  $\geq 60^{\circ}\text{C}$ , heat resistant cables shall be used with a rating of at least 20 K above the ambient temperature.

The surface temperature of the enclosure is equal to the ambient temperature plus 20 K, for a dust layer with a thickness up to 5 mm

## Installation Drawing 5300Q502.

### Model 5331C, 5331D, 5333C and Hazardous (Classified) Location

Class I, Division 1, Groups A, B, C, D  
Class II Division 1 Groups E, F, G or  
Class I, Zone 0, IIC

Ambient temperature limits  
T4: -40 to + 85 deg. Celcius  
T6: -40 to + 60 deg. Celcius

Terminal 1, 2  
Vmax or Ui: 30 V  
Imax or Ii: 120 mA  
Pmax or Pi: 0.84 W  
Ci: 1 nF  
Li: 10 uH

Terminal 3, 4, 5, 6  
Only passive, or non-energy  
storing devices such as RTD's  
and Thermocouples may be  
connected.

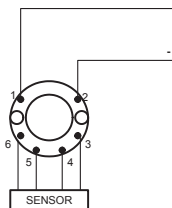

### 5333D Non Hazardous Location

Associated Apparatus  
or Barrier  
with  
entity Parameters:

$UM \leq 250V$   
 $Voc \text{ or } Uo \leq Vmax \text{ or } Ui$   
 $Isc \text{ or } Io \leq Imax \text{ or } Ii$   
 $Po \leq Pi$   
 $Ca \text{ or } Co \geq Ci + Ccable$   
 $La \text{ or } Lo \geq Li + Lcable$

This device must not be  
connected to any associated  
apparatus which uses or  
generates more than 250 VRMS

### Model 5335C, 5335D.

#### Hazardous (Classified) Location

Class I, Division 1, Groups A, B, C, D  
Class II Division 1 Groups E, F, G or  
Class I, Zone 0, IIC

Ambient temperature limits  
T4: -40 to + 85 deg. Celcius  
T6: -40 to + 60 deg. Celcius

Terminal 1, 2  
Vmax or Ui: 30 V  
Imax or Ii: 120 mA  
Pmax or Pi: 0.84 W  
Ci: 1 nF  
Li: 10 uH

Terminal 3, 4, 5, 6  
Vt or Uo: 9.6 V  
It or Io: 28 mA  
Pt or Po: 67.2 mW  
Ca or Co: 3.5 uF  
La or Lo: 35 mH

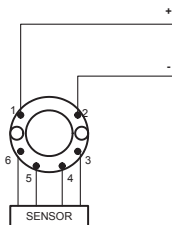

#### Non Hazardous Location

Associated Apparatus  
or Barrier  
with  
entity Parameters:

$UM \leq 250V$   
 $Voc \text{ or } Uo \leq Vmax \text{ or } Ui$   
 $Isc \text{ or } Io \leq Imax \text{ or } Ii$   
 $Po \leq Pi$   
 $Ca \text{ or } Co \geq Ci + Ccable$   
 $La \text{ or } Lo \geq Li + Lcable$

This device must not be  
connected to any associated  
apparatus which uses or  
generates more than 250 VRMS

## The entity concept.

The Transmitter must be installed according to National Electrical Code (ANSI-NFPA 70).

When installed in Class II locations the Transmitter shall be installed in an enclosure with a specified ingress protections of IP6X according to IEC60529 and Dust-tight conduit seals must be used.

Equipment that is FM-approved for intrinsic safety may be connected to barriers based on the ENTITY CONCEPT. This concept permits interconnection of approved transmitters, meters and other devices in combinations which have not been specifically examined by FM, provided that the agency's criteria are met. The combination is then intrinsically safe, if the entity concept is acceptable to the authority having jurisdiction over the installation.

The entity concept criteria are as follows:

The intrinsically safe devices, other than barriers, must not be a source of power. The maximum voltage  $U_i(V_{MAX})$  and current  $I_i(I_{MAX})$ , and maximum power  $P_i(P_{max})$ , which the device can receive and remain intrinsically safe, must be equal to or greater than the voltage ( $U_o$  or  $V_{oc}$  or  $V_i$ ) and current ( $I_o$  or  $I_{sc}$  or  $I_i$ ) and the power  $P_o$  which can be delivered by the barrier.

The sum of the maximum unprotected capacitance ( $C_i$ ) for each intrinsically device and the interconnecting wiring must be less than the capacitance ( $C_a$ ) which can be safely connected to the barrier.

The sum of the maximum unprotected inductance ( $L_i$ ) for each intrinsically device and the interconnecting wiring must be less than the inductance ( $L_a$ ) which can be safely connected to the barrier.

The entity parameters  $U_o, V_{oc}$  or  $V_i$  and  $I_o, I_{sc}$  or  $I_i$ , and  $C_a$  and  $L_a$  for barriers are provided by the barrier manufacturer.

## CSA Installation Drawing 533XQC03.

5331D, 5333D and 5335D transmitters are intrinsically safe in Zone 0 Group IIC or Class I, Division 1, Group A,B,C,D when installed according to Installation Drawing.

### 1. Connections with separate power supply and receiver.

Output: Standard 4 – 20 mA loop

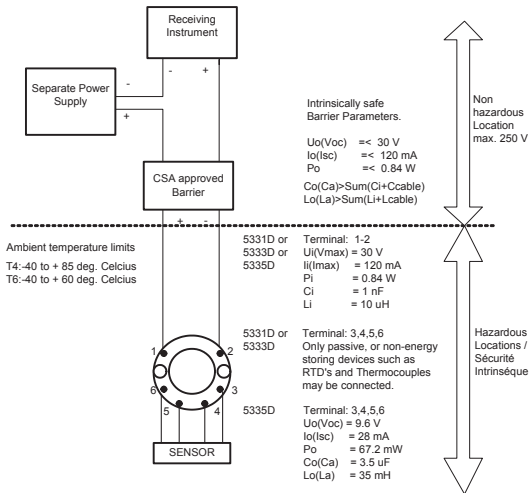

### Warning:

Substitution of components may impair intrinsic safety.

The transmitters must be installed in a suitable enclosure to meet installation codes stipulated in the Canadian Electrical Code (CEC).

**2. Connection with power supply and barrier built into receiver.**  
**Output: Standard 4 - 20 mA loop**

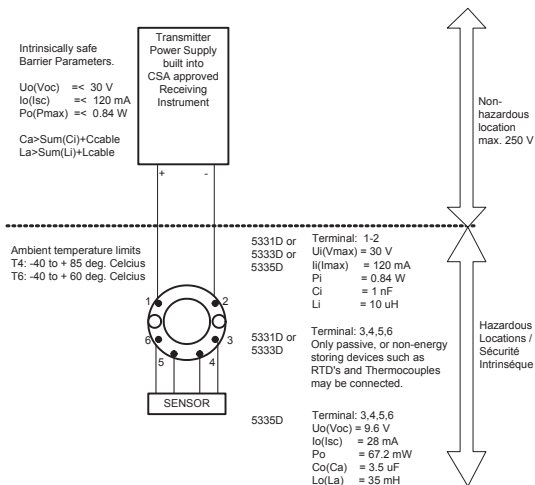

**Warning:**  
 Substitution of components may impair intrinsic safety.

The Transmitters must be installed in a suitable enclosure to meet installation codes stipulated in the Canadian Electrical Code (CEC).



**Displays** Programmable displays with a wide selection of inputs and outputs for display of temperature, volume and weight, etc. Feature linearisation, scaling, and difference measurement functions for programming via PReset software.



**Ex interfaces** Interfaces for analogue and digital signals as well as HART® signals between sensors / I/P converters / frequency signals and control systems in Ex zone 0, 1 & 2 and for some modules in zone 20, 21 & 22.



**Isolation** Galvanic isolators for analogue and digital signals as well as HART® signals. A wide product range with both loop-powered and universal isolators featuring linearisation, inversion, and scaling of output signals.



**Temperature** A wide selection of transmitters for DIN form B mounting and DIN rail modules with analogue and digital bus communication ranging from application-specific to universal transmitters.



**Universal** PC or front programmable modules with universal options for input, output and supply. This range offers a number of advanced features such as process calibration, linearisation and auto-diagnosis.



- 

[www.preelectronics.fr](http://www.preelectronics.fr)  

[sales@preelectronics.fr](mailto:sales@preelectronics.fr)
- 

[www.preelectronics.de](http://www.preelectronics.de)  

[sales@preelectronics.de](mailto:sales@preelectronics.de)
- 

[www.preelectronics.es](http://www.preelectronics.es)  

[sales@preelectronics.es](mailto:sales@preelectronics.es)
- 

[www.preelectronics.it](http://www.preelectronics.it)  

[sales@preelectronics.it](mailto:sales@preelectronics.it)
- 

[www.preelectronics.se](http://www.preelectronics.se)  

[sales@preelectronics.se](mailto:sales@preelectronics.se)
- 

[www.preelectronics.co.uk](http://www.preelectronics.co.uk)  

[sales@preelectronics.co.uk](mailto:sales@preelectronics.co.uk)
- 

[www.preelectronics.com](http://www.preelectronics.com)  

[sales@preelectronics.com](mailto:sales@preelectronics.com)
- 

[www.preelectronics.cn](http://www.preelectronics.cn)  

[sales@preelectronics.cn](mailto:sales@preelectronics.cn)

## Head office

Denmark  
 PR electronics A/S  
 Lerbakken 10  
 DK-8410 Rønne

[www.preelectronics.com](http://www.preelectronics.com)  
[sales@preelectronics.dk](mailto:sales@preelectronics.dk)  
 tel. +45 86 37 26 77  
 fax +45 86 37 30 85

