

PR
electronics



5 3 3 3

**Transmissor
programável 2 fios**

No. 5333V111-BR

De número de serial:

132094001 - 132094630

141115001 →



ATEX



Revision Notes

The following list provides notes concerning revisions of this document.

Rev. ID	Date	Notes
111	13/45	IECEX and INMETRO approvals added

Todos os clientes poderão declarar uma reclamação através do telefone 0XX19-3429-7890 ou email suporte@tsie.com.br ou pelo site: http://www.technosupply.com.br/blog/?page_id=103

TRANSMISSOR PROGRAMÁVEL 2 FIOS

PRetop 5333

Conteúdo

Aplicação	2
Características técnicas	2
Montagem / instalação.....	2
Aplicações.....	3
Ordem: 5333.....	4
Especificações elétricas	4
Conexões.....	7
Diagrama de bloco	8
Programação	9
Especificações mecânicas	10
Montagem dos fios do sensor	10
Appendix	11
ATEX Installation Drawing - 5333A	12
ATEX Installation Drawing - 5333D	13
IECEX Installation Drawing - 5333A.....	15
IECEX Installation Drawing - 5333D.....	16
FM Installation Drawing - 5333D.....	18
CSA Installation Drawing - 5333D.....	20
INMETRO Instruções de Segurança - 5333A.....	21
INMETRO Instruções de Segurança - 5333D.....	22

TRANSMISSOR PROGRAMÁVEL 2 FIOS PRetop 5333

- *Entrada RTD ou Ohm*
- *Alta precisão de medição*
- *Conexão 3 fios*
- *Valor de erro de sensor programável*
- *Montagem do sensor tipo cabeçote para trilho DIN B*

Aplicação

- Medição de temperatura linearizada com Pt100...Pt1000 ou sensor Ni100...Ni1000.
- Conversão de variação de resistência linear para um sinal de corrente analógico padrão por exemplo válvulas ou sensor de nível Ohmico

Características técnicas

- Em poucos segundos o usuário pode programa o PR5331 para medição de temperaturas com todos os ranges definidos pelas normas.
- As entradas de RTD e resistência possuem cabo de compensação para conexão 3-fios.

Montagem / instalação

- Para sensor tipo cabeçote de montagem em DIN B. Em áreas não perigosas o 5333 pode ser montado em trilho DIN com o acessório da PR tipo 8421.
- **NB:** Como barreira Ex para o 5333D nós recomendamos o 5401B, 5114B, ou 5116B.

APLICAÇÕES

RTD à 4...20 mA

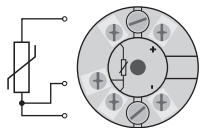

Instalação de 2 fios
na sala de controle

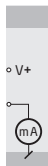

Resistência à 4...20 mA

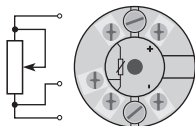

Instalação de 2 fios
na sala de controle

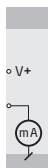

Ordem: 5333

Tipo	Versão
5333	Padrão : A CSA, FM, ATEX, IECEx & INMETRO : D

Especificações elétricas

Especificações de range:

-40°C a +85°C

Especificações comuns:

Tensão de alimentação, DC

Padrão..... 8...35 V

CSA, FM, ATEX, IECEx & INMETRO..... 8...30 V

Consumo interno..... 25 mW...0.8 W

Queda de tensão..... 8 VDC

Tempo de aquecimento..... 5 min.

Interface de comunicações..... Loop Link

Sinal / ruído..... Min. 60 dB

Tempo de resposta (programável)..... 0.33...60 s

Dinâmicas de sinal, entrada..... 19 bit

Dinâmicas de sinal, saída..... 16 bit

Temperatura de calibração..... 20...28°C

Precisão, a melhor para valores gerais e básicos:

Valores Gerais		
Tipo de entrada	Precisão absoluta	Coefficiente de temperatura
Todas	$\leq \pm 0.1\%$ de span	$\leq \pm 0.01\%$ de span / °C

Valores básicos		
Tipo de entrada	Precisão básica	Coefficiente de temperatura
RTD	$\leq \pm 0.3^\circ\text{C}$	$\leq \pm 0.01^\circ\text{C}/^\circ\text{C}$
Lin. R	$\leq \pm 0.2 \Omega$	$\leq \pm 20 \text{ m}\Omega / ^\circ\text{C}$

Influência de imunidade EMC.....	$< \pm 0.5\%$ de span
----------------------------------	-----------------------

Efeito de variação da tensão de alimentação	≤ 0,005% de span / VDC
Vibração	IEC 60068-2-6 Teste FC
2...25 Hz.....	±1,6 mm
25...100 Hz	±4 g
Tamanho máximo do fio	1 x 1.5 mm ² fio flexível
Umidade.....	< 95% RH (não-cond.)
Dimensões.....	Ø 44 x 20.2 mm
Grau de proteção (enclausurado / terminal).....	IP68 / IP00
Peso.....	50 g

Especificações elétricas, entradas:

Entrada RTD e resistência linear:

RTD type	Min. value	Max. value	Min. span	Standard
Pt100	-200°C	+850°C	25°C	IEC 60751
Ni100	-60°C	+250°C	25°C	DIN 43760
Lin. R	0 Ω	10000 Ω	30 Ω	-----

Compensação máx.	50% do valor máx. selecionado
Resistência do cabo por fio (max.)	10 Ω
Corrente do sensor.....	> 0.2 mA, < 0.4 mA
Efeito de resistência de cabo do sensor (3-fios).....	< 0.002 Ω / Ω
Deteção de erro de sensor.....	Sim

Saída:

Saída de corrente:

Range de sinal	4...20 mA
Range de sinal mín.....	16 mA
Tempo de atualização.....	135 ms
Resistência de carga	≤ (V _{alimentação} - 8) / 0.023 [Ω]
Estabilidade de carga.....	< ±0.01% de span / 100 Ω

Deteção de erro de sensor:

Programável.....	3.5...23 mA
NAMUR NE43 Acima de escala.....	23 mA
NAMUR NE43 Abaixo de escala	3.5 mA

De span = De range presentemente selecionado

Aprovações:

EMC 2004/108/EC EN 61326-1

GOST R

Aprovação marinha:

Det Norske Veritas, Ships & Offshore Stand. f. Certific. No. 2.4

Ex / S.I.:

ATEX 94/9/EC

5331A..... KEMA 10ATEX0003 X

5331D..... KEMA 03ATEX1535 X

Certificado FM..... 2D5A7

Certificado CSA..... 1125003

IECEX..... DEK 13.0036 X

INMETRO DEKRA 13.0002 X

GOST Ex

CONEXÕES

Entrada:

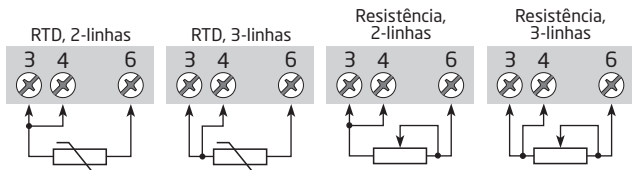

Saída:



DIAGRAMA DE BLOCO



Especificações mecânicas

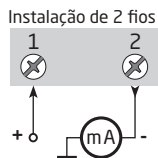
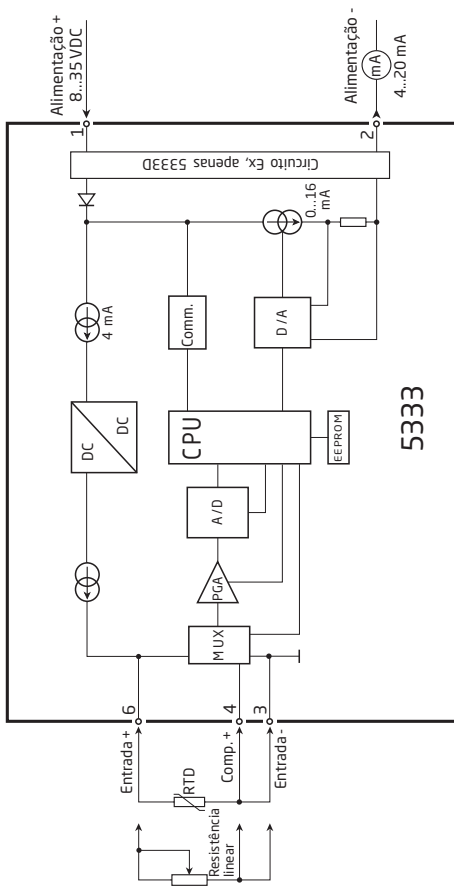
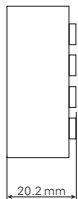
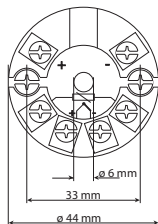

Montagem dos fios do sensor

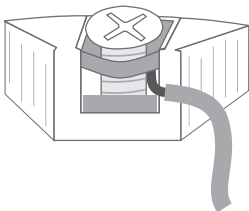

Fios devem ser montados entre as chapas de metal.

APPENDIX

ATEX Installation Drawing - 5333A

ATEX Installation Drawing - 5333D

IECEx installation drawing - 5333A

IECEx installation drawing - 5333D

FM Installation Drawing - 5333D

CSA Installation Drawing - 5333D

INMETRO Instruções de Segurança - 5333A

INMETRO Instruções de Segurança - 5333D

ATEX Installation drawing

For safe installation of 5333A the following must be observed. The module shall only be installed by qualified personnel who are familiar with the national and international laws, directives and standards that apply to this area.

Year of manufacture can be taken from the first two digits in the serial number.

ATEX Certificate KEMA 10ATEX 0003X

Marking  II 3 G Ex nA [ic] IIC T4 ... T6 Gc
II 3 G Ex ic IIC T4...T6 Gc
II 3 D Ex ic IIIC Dc

Standards EN 60079-0 : 2012, EN 60079-11 : 2012, EN 60079-15 : 2010

T4: $-40 \leq T_a \leq 85^{\circ}\text{C}$ T6: $-40 \leq T_a \leq 60^{\circ}\text{C}$	Terminal: 3,4,6 Ex nA [ic] Uo: 5V Io: 4.0 mA Po: 20 mW Lo: 900 mH Co: 1000 μF	Terminal: 1,2 Ex nA Umax. \leq 35 VDC	Terminal: 1,2 Ex ic Ui = 35 VDC Ii = 110mA Li = 10 μH Ci = 1.0 nF
--	---	--	--

Special conditions for safe use

For type of protection Ex nA, the transmitter shall be mounted in a metal enclosure providing a degree of protection of at least IP54 according to EN60529.

For use in the presence of combustible dusts the transmitter shall be mounted in an enclosure providing a degree of protection of at least IP6X in accordance with EN60529, the surface temperature of the outer enclosure is 20 K above the ambient temperature

For an ambient temperature $\geq 60^{\circ}\text{C}$, heat resistant cables shall be used with a rating of at least 20 K above the ambient temperature.

ATEX Installation drawing



For safe installation of 5333D the following must be observed. The module shall only be installed by qualified personnel who are familiar with the national and international laws, directives and standards that apply to this area.

Year of manufacture can be taken from the first two digits in the serial number.

ATEX Certificate KEMA 03ATEX 1535 X

Marking  II 1 G Ex ia IIC T4...T6 Ga
II 1 D Ex ia IIIC Da
II 1 M Ex ia I Ma

Standards EN 60079-0 : 2012, EN 60079-11 : 2012, EN 60079-26 : 2007,
EN 60079-15 : 2010

Hazardous area

Zone 0, 1, 2, 20, 21, 22

T4: $-40 \leq T_a \leq 85^\circ\text{C}$

T6: $-40 \leq T_a \leq 60^\circ\text{C}$

Terminal: 3,4,6

Uo: 27 VDC

Io: 7 mA

Po: 45 mW

Lo: 35 mH

Co: 90 nF

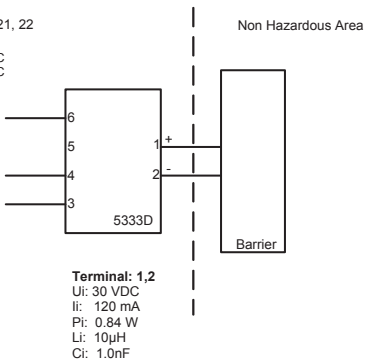

Installation notes:

In a potentially explosive gas atmosphere, the transmitter shall be mounted in an enclosure in order to provide a degree of protection of at least IP20 according to EN60529.

If the transmitter is installed in an explosive atmosphere requiring the use of equipment of category 1 G, 1 M or 2 M, and if the enclosure is made of aluminum, it must be installed such that ignition sources due to impact and friction sparks are excluded.

If the enclosure is made of non-metallic materials, electrostatic charging shall be avoided.

For installation in a potentially explosive dust atmosphere, the following instructions apply:

The transmitter shall be mounted in a metal enclosure form B that is providing a degree of protection of at least IP6X according to EN60529, that is suitable for the application and correctly installed.

Cable entries and blanking elements shall be used that are suitable for the application and correctly installed.

For an ambient temperature $\geq 60^{\circ}\text{C}$, heat resistant cables shall be used with a rating of at least 20 K above the ambient temperature.

The surface temperature of the enclosure is equal to the ambient temperature plus 20 K, for a dust layer with a thickness up to 5 mm

IECEx Installation drawing



For safe installation of 5333A or 5343A the following must be observed. The module shall only be installed by qualified personnel who are familiar with the national and international laws, directives and standards that apply to this area.

Year of manufacture can be taken from the first two digits in the serial number.

Certificate	IECEx DEK 13.0036X		
Marking	Ex nA [ic] IIC T6..T4 Gc	T4: $-40 \leq T_a \leq 85^\circ\text{C}$	
	Ex ic IIC T6..T4 Gc	T6: $-40 \leq T_a \leq 60^\circ\text{C}$	
	Ex ic IIIC Dc		
Standards	IEC 60079-0 : 2011, IEC 60079-11 : 2011, IEC 60079-15 : 2010		

Terminal	Ex nA [ic]	Ex ic
1,2	U _{max} = 35V	U _i : 35V, I _i :110mA, I _i :10μH, C _i :1,0nF
3,4,6	U _o : 5V, I _o : 4mA, P _o : 20mW, L _o : 900mH, C _o : 1000μF	

Installation note:

For installation in a potentially explosive gas atmosphere, the following instructions apply:

For nA installation the transmitter must be installed in an metal enclosure e.g. a form B enclosure, providing a degree of protection of at least IP54 according to IEC60529 or in an enclosure with type of protection Ex n or Ex e.

For ic installation the transmitter must be installed in enclosure providing a degree of protection of at least IP20 according to IEC60529 and that is suitable for the application.

Cable entry devices and blanking elements shall fulfill the same requirements

For an ambient temperature $\geq 60^\circ\text{C}$, heat resistant cables shall be used with a rating of at least 20 K above the ambient temperature.

For installation in a potentially explosive dust atmosphere, the following instructions apply:

The surface temperature of the enclosure is equal to the ambient temperature plus 20 K, for a dust layer with a thickness up to 5 mm.

The transmitter must be mounted in a enclosure according to DIN 43729 that provides a degree of protection of at least IP6X according to IEC60529, and that is suitable for the application. Cable entry devices and blanking elements shall fulfill the same requirements.

IECEx Installation drawing



For safe installation of 5333D or 5343B the following must be observed. The module shall only be installed by qualified personnel who are familiar with the national and international laws, directives and standards that apply to this area.

Year of manufacture can be taken from the first two digits in the serial number.

Certificate	IECEx DEK 13.0036X
Marking	Ex ia IIC T4...T6 Ga Ex ia IIC Da Ex ia I Ma
Standards	IEC 60079-0 : 2011, IEC 60079-11 : 2011, IEC 60079-26:2006

Hazardous area
Zone 0, 1, 2, 20, 21, 22, M1

T4: $-40 \leq T_a \leq 85^\circ\text{C}$

T5: $-40 \leq T_a \leq 60^\circ\text{C}$

T6: $-40 \leq T_a \leq 45^\circ\text{C}$

Non Hazardous Area

Terminal: 3,4,6

U_o: 30 VDC

I_o: 8 mA

P_o: 60 mW

L_o: 35 mH

C_o: 66 nF

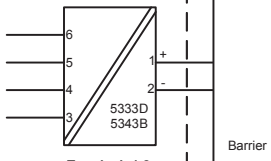

Terminal: 1,2

U_i: 30 VDC

I_i: 120 mA

P_i: 0.84 W

L_i: 10μH

C_i: 1.0nF

Installation notes.

In a potentially explosive gas atmosphere, the transmitter shall be mounted in a metal form B enclosure in order to provide a degree of protection of at least IP20 according to IEC60529. If however the environment requires a higher degree of protection, this shall be taken into account.

If the transmitter is installed in an explosive atmosphere requiring the use of equipment protection level Ga, Ma and Mb, and if the enclosure is made of aluminum, it must be installed such, that ignition sources due to impact and friction sparks are excluded.

For installation in a potentially explosive dust atmosphere, the following instructions apply:

For explosive dust atmospheres, the surface temperature of the outer enclosure is 20 K above the ambient temperature.

The transmitter shall be mounted in a metal enclosure form B according to DIN43729 that is providing a degree of protection of at least IP6X according to IEC60529, that is suitable for the application and correctly installed.

Cable entries and blanking elements shall be used that are suitable for the application and correctly installed.

For an ambient temperature $\geq 60^{\circ}\text{C}$, heat resistant cables shall be used with a rating of at least 20 K above the ambient temperature.

FM Installation Drawing 5300Q502 Rev AH

Model 5331C, 5331D, 5333C, 5333D and 5343B

Hazardous (Classified) Location

Class I, Division 1, Groups, A, B, C, D
Class I, Zone 0, IIC

Ambient temperature limits
T4: -40 to +85 deg. Celsius
T6: -40 to +60 deg. Celsius

Terminal 1, 2
Vmax or Ui: 30 V
Imax or Ii: 120 mA
Pmax or Pi: 0.84 W
Ci: 1 nF
Li: 10 uH

Terminal 3, 4, 5, 6
Only passive, or non-energy storing devices such as RTD's and Thermocouples may be connected.

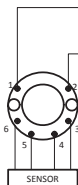

Non Hazardous Location

Associated Apparatus
or Barrier
with
entity Parameters:

$UM \leq 250V$
 $Voc \text{ or } Uo \leq Vmax \text{ or } Ui$
 $Isc \text{ or } Io \leq Imax \text{ or } Ii$
 $Po \leq Pi$
 $Ca \text{ or } Co \geq Ci + Ccable$
 $La \text{ or } Lo \geq Li + Lcable$

This device must not be connected to any associated apparatus which uses or generates more than 250 VRMS

Model 5335C, 5335D, 5336D, 5337D

Hazardous (Classified) Location

Class I, Division 1, Groups, A, B, C, D
Class I, Zone 0, IIC

Ambient temperature limits
T4: -40 to +85 deg. Celsius
T6: -40 to +60 deg. Celsius

Terminal 1, 2
Vmax or Ui: 30 V
Imax or Ii: 120 mA
Pmax or Pi: 0.84 W
Ci: 1 nF
Li: 10 uH

Terminal 3, 4, 5, 6
Vi or Uo: 9.6 V
Ii or Io: 28 mA
Pi or Po: 67.2 mW
Ca or Co: 3.5 uF
La or Lo: 35 mH

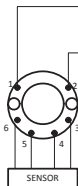

Non Hazardous Location

Associated Apparatus
or Barrier
with
entity Parameters:

$UM \leq 250V$
 $Voc \text{ or } Uo \leq Vmax \text{ or } Ui$
 $Isc \text{ or } Io \leq Imax \text{ or } Ii$
 $Po \leq Pi$
 $Ca \text{ or } Co \geq Ci + Ccable$
 $La \text{ or } Lo \geq Li + Lcable$

This device must not be connected to any associated apparatus which uses or generates more than 250 VRMS

The entity concept

The Transmitter must be installed according to National Electrical Code (ANSI-NFPA 70) and shall be installed with the enclosure, mounting, and spacing segregation requirement of the ultimate application.

Equipment that is FM-approved for intrinsic safety may be connected to barriers based on the ENTITY CONCEPT. This concept permits interconnection of approved transmitters, meters and other devices in combinations which have not been specifically examined by FM, provided that the agency's criteria are met. The combination is then intrinsically safe, if the entity concept is acceptable to the authority having jurisdiction over the installation.

The entity concept criteria are as follows:

The intrinsically safe devices, other than barriers, must not be a source of power.

The maximum voltage $U_i(V_{MAX})$ and current $I_i(I_{MAX})$, and maximum power $P_i(P_{MAX})$, which the device can receive and remain intrinsically safe, must be equal to or greater than the voltage (U_o or V_{OC} or V_i) and current (I_o or I_{SC} or I_i) and the power P_o which can be delivered by the barrier.

The sum of the maximum unprotected capacitance (C_i) for each intrinsically device and the interconnecting wiring must be less than the capacitance (C_a) which can be safely connected to the barrier.

The sum of the maximum unprotected inductance (L_i) for each intrinsically device and the interconnecting wiring must be less than the inductance (L_a) which can be safely connected to the barrier.

The entity parameters U_o, V_{OC} or V_i and I_o, I_{SC} or I_i , and C_a and L_a for barriers are provided by the barrier manufacturer.

NI Field Circuit Parameters

Model 5331C, 5331D, 5333C, 5333D, 5335C, 5335D, 5336D, 5337D and 5343B

Hazardous (Classified) Location

Class I, Division 2, Groups, A, B, C, D
Class I, Zone 2, IIC

Ambient temperature limits
T4: -40 to +85 deg. Celcius
T6: -40 to +60 deg. Celcius

Terminal 1, 2
 V_{max} : 35 V
 C_i : 0 μ F
 L_i : 10 μ H

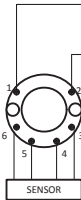

Non Hazardous Location

Associated Apparatus
or Barrier

This device must not be connected to any associated apparatus which uses or generates more than 250 VRMS

CSA Installation drawing 533XQC03

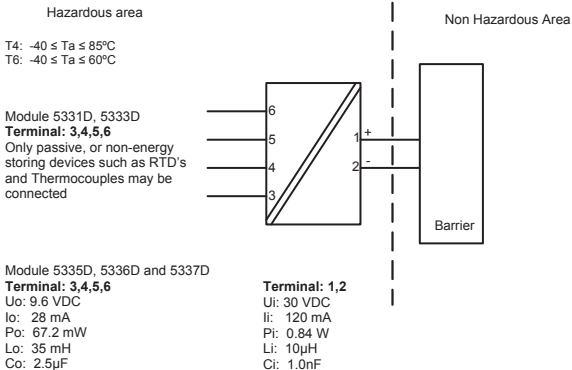

CLASS 2258 04 - PROCESS CONTROL EQUIPMENT - Intrinsically Safe Entity - For Hazardous Locations
Class I, Division 1, Groups A, B, C and D
Ex ia IIC, Ga

CLASS 2258 84 - PROCESS CONTROL EQUIPMENT - Intrinsically Safe Entity - For Hazardous Locations - Certified to US Standards
Class I, Division 1, Groups A, B, C and D
Class I, Zone 0, AEx ia IIC, Ga

Warning:

Substitution of components may impair intrinsic safety.

The transmitters must be installed in a suitable enclosure to meet installation codes stipulated in the Canadian Electrical Code (CEC) or for US the National Electrical Code (NEC).

Desenho de Instalação InMETRO



Para instalação segura do 5333A ou 5343A o seguinte deve ser observado. O modo deve apenas ser instalado por pessoas qualificadas que são familiarizadas com as leis nacionais e internacionais, diretrizes e padrões que se aplicam a esta área.
 Ano de fabricação pode ser pego dos dois primeiros dígitos do número de série.

Certificado	IECEX DEK 13.0002 X	
Indicação	Ex nA [ic] IIC T6..T4 Gc	T4: $-40 \leq Ta \leq 85^{\circ}\text{C}$
	Ex ic IIC T6..T4 Gc	T6: $-40 \leq Ta \leq 60^{\circ}\text{C}$
	Ex ic IIIC Dc	

Padrões ABNT NBR IEC 60079-0 : 2008, ABNT NBR IEC 60079-11 : 2009,
 IEC 60079-15 : 2010, ABNT NBR IEC 60079-26 : 2008

Terminal	Ex nA [ic]	Ex ic
1,2	U _{max} = 35V	Ui : 35V, Ii:110mA, Ii:10μH, Ci:1,0nF
3,4,6	Uo: 5V, Io: 4mA, Po: 20mW, Lo: 900mH, Co: 1000μF	

Notas para instalação

Para a instalação em uma atmosfera de gás potencialmente explosivo, se aplicam as instruções a seguir:

Para a instalação nA o transmissor deve ser instalado em um gabinete de metal, por exemplo, gabinete em forma B que forneça um grau de proteção de pelo menos IP54 de acordo com IEC60529 ou em uma caixa com tipo de proteção Ex n ou Ex e.

Para a instalação iC o transmissor deve ser instalado em um invólucro proporcionando um grau de proteção de IP20, pelo menos, de acordo com a norma IEC60529 que é adequado para a aplicação.

Dispositivos de entrada de cabos e elementos de supressão devem cumprir os mesmos requisitos.

Para uma temperatura ambiente $\geq 60^{\circ}\text{C}$, os cabos resistentes ao calor precisam ser utilizados com uma classificação de pelo menos 20 K acima da temperatura ambiente.

Para a instalação em uma atmosfera de poeira potencialmente explosiva, se aplicam as instruções a seguir:

A temperatura da superfície do invólucro é igual à temperatura ambiente mais 20 K, para uma camada de pó, com uma espessura superior a 5 mm.

O transmissor deve ser montado em um invólucro de acordo com a norma DIN 43729, que proporciona um grau de proteção de, pelo menos, IP6X de acordo com a norma IEC60529, e que seja apropriado para a aplicação.

Dispositivos de entrada de cabos e elementos de supressão devem cumprir as mesmas exigências

Desenho de Instalação InNMETRO



Para instalação segura do 5333D ou 5343B o seguinte deve ser observado. O modo deve apenas ser instalado por pessoas qualificadas que são familiarizadas com as leis nacionais e internacionais, diretrizes e padrões que se aplicam a esta área.
Ano de fabricação pode ser pego dos dois primeiros dígitos do número de série.

Certificado	DEKRA 13.0002 X
Indicação	Ex ia IIC T6...T4 Ga Ex ia IIIC Da
Padrões	ABNT NBR IEC 60079-0 : 2008, ABNT NBR IEC 60079-11 : 2009, IEC 60079-15 : 2010, ABNT NBR IEC 60079-26 : 2008

Áreas perigosas

Zona 0, 1, 2, 20, 21, 22, M1

T4: $-40 \leq T_a \leq 85^\circ\text{C}$

T5: $-40 \leq T_a \leq 60^\circ\text{C}$

T6: $-40 \leq T_a \leq 45^\circ\text{C}$

Sem áreas perigosas

Terminal: 3,4,5,6

Uo: 30 VDC

Io: 8 mA

Po: 60 mW

Lo: 35 mH

Co: 66 nF

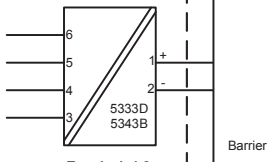

Terminal: 1,2

Ui: 30 VDC

Ii: 120 mA

Pi: 0,84 W

Li: 10 μH

Ci: 1,0 nF

Notas de Instalação.

Em uma atmosfera de gás potencialmente explosiva, o transmissor deve ser montado em um enclosure a fim de garantir um grau de proteção de no mínimo IP20 de acordo com EN60529. Se contudo o ambiente requer um nível de proteção maior, isso deve ser levado em conta

Se o transmissor é instalado em uma atmosfera explosiva exigindo o uso de equipamento de categoria Ga e se o enclosure é feito de alumínio, ele deve ser instalado de modo que, mesmo em caso de avaria rara, fontes de ignição devido a impacto e fricção, faíscas são eliminadas; se o enclosure é feito de materiais não metálicos, cargas eletroestáticas devem ser evitadas.

Para instalação em atmosfera de poeira potencialmente explosiva, as instruções a seguir:

O transmissor deve ser montado em enclosure de metal forma B de acordo com DIN43729 que está fornecendo um grau de proteção de pelo menos IP6X de acordo com EN60529. Isso é adequado para aplicação e corretamente instalado.

As entradas dos cabos e os elementos de obturação que podem ser utilizados são adequados para a aplicação e corretamente instalados.

Para temperatura ambiente $\geq 60^{\circ}\text{C}$, fios de resistência ao calor devem ser usados com uma faixa de pelo menos 20K acima da temperatura ambiente.

A temperatura da superfície do enclosure é igual à temperatura ambiente mais de 20 K, por uma camada de pó, com uma espessura até 5 mm.



Displays Displays programáveis com uma grande variedade de entradas e saídas para visualização de temperatura, volume, peso, etc. Linearização de fábrica, escala, e diferentes funções de medição para programação via software PReset.



Interfaces Ex Interfaces para sinais analógicos e digitais assim como sinais HART® entre sensores / conversores I/P / sinais de frequência e sistemas de controle em zona Ex 0, 1 & 2 e para alguns módulos em zona 20, 21 & 22.



Isolação Isoladores galvânicos para sinais analógicos e digitais bem como sinais HART®. Um grande range de produtos, todos com loop de alimentação e isoladores de sinais com linearização, inversão e escala de sinais de saída.



























Temperatura Uma grande variedade de transmissores para montagem em trilho DIN B e módulos de trilho DIN com comunicação de dados digitais e analógicos variando para cada aplicação-específica de transmissores universais.



Universal Módulos programáveis via PC ou display frontal com opções universais para entrada, saída e alimentação. Este range oferece um número de configurações avançadas como processo de calibração, linearização e auto diagnóstico.



- 
 www.preelectronics.fr
 sales-fr@preelectronics.com
- 
 www.preelectronics.de
 sales-de@preelectronics.com
- 
 www.preelectronics.es
 sales-es@preelectronics.com
- 
 www.preelectronics.it
 sales-it@preelectronics.com
- 
 www.preelectronics.se
 sales-se@preelectronics.com
- 
 www.preelectronics.co.uk
 sales-uk@preelectronics.com
- 
 www.preelectronics.com
 sales-us@preelectronics.com
- 
 www.preelectronics.cn
 sales-cn@preelectronics.com

Sede

Dinamarca
 PR electronics A/S
 Lerbakken 10
 DK-8410 Rønde

www.preelectronics.com
sales-dk@preelectronics.com
 tel. +45 86 37 26 77
 fax +45 86 37 30 85



QUALITY SYSTEM AND ENVIRONMENTAL MANAGEMENT SYSTEM
 DS/EN ISO 9001
 DS/EN ISO 14001

