

PR
electronics



5 3 3 4

**2-Draht Universal-
Messumformer**

Nr. 5334V110-DE
Ab Seriennr. 141365001



CCOE **Ex** EAC **CE**

Revision Notes

The following list provides notes concerning revisions of this document.

Rev. ID	Date	Notes
108	13/45	IECEX and INMETRO approvals added
109	15/14	PESO/CCOE approval added GOST approval replaced with EAC approval
115	17/07	INMETRO installation drawings updated

2-DRAHT UNIVERSALMESSUMFORMER

5334

INHALTSVERZEICHNIS

Verwendung.....	2
Technische Merkmale.....	2
Montage / Installation	2
Anwendungen.....	3
Bestellangaben: 5334	4
Elektrische Daten	4
Anschlüsse	7
Blockdiagramm.....	8
Programmierung.....	9
Abmessungen	10
Montage von Fühlerleitungen.....	10
Appendix	11
ATEX Installation Drawing - 5334A	12
ATEX Installation Drawing - 5334B	13
IECEX Installation Drawing - 5334A.....	15
IECEX Installation Drawing - 5334B.....	16
INMETRO Instruções de Segurança - 5334A.....	18
INMETRO Instruções de Segurança - 5334B.....	19

2-DRAHT UNIVERSALMESSUMFORMER 5334

- *Eingang TE*
- *Hohe Messgenauigkeit*
- *Galvanische Trennung*
- *Programmierbare Sensorfehlanzeige*
- *Für Einbau in Anschlusskopf DIN Form B*

Verwendung

- Linearisierte Temperaturmessung mit Thermoelementsensor.
- Verstärkung von bipolaren mV-Signalen, eventuell nach definierter Linearisierungsfunktion, zu einem 4...20 mA Signal linearisiert.

Technische Merkmale

- PR5334 kann vom Benutzer innerhalb von wenigen Sekunden zur Messung in allen genormten TE-Temperaturbereiche programmiert werden.
- CJC-Vergleichstellenkompensation mit eingebautem Temperaturfühler.
- Die gespeicherten Daten werden laufend kontrolliert.

Montage / Installation

- Für DIN Form B Sensorkopf Montage. Im sicheren Bereich kann der 5334 auf einer DIN-Schiene mittels der PR-Armatur Typ 8421 montiert werden.

ANWENDUNGEN

TE en 4...20 mA

2-Draht-Installation
im Kontrollraum

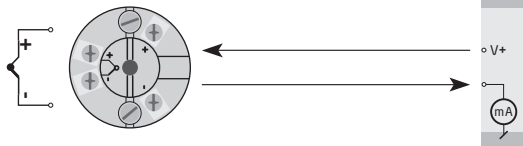

mV in 4...20 mA

2-Draht-Installation
im Kontrollraum

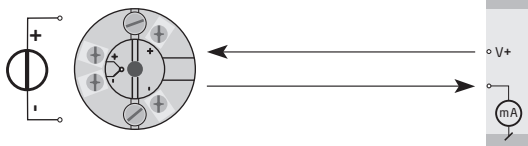

Bestellangaben: 5334

Typ	Version	Umgebungs- temperatur	Galvanische Trennung
5334	Standard : A	-40°C...+85°C : 3	1500 VAC : B
	ATEX Ex, IECEx & INMETRO : B		

Elektrische Daten

Spezifikationsbereich:

-40°C bis +85°C

Allgemeine Daten:

Versorgungsspannung, DC

Standard..... 7,2...35 V

ATEX Ex, IECEx & INMETRO 7,2...30 VDC

Verlustleistung

Standard..... 25 mW...0,8 W

CSA, FM, ATEX, IECEx & INMETRO..... 25 mW...0,7

Spannungsabfall 7,2 VDC

Isolationsspannung, Test / Betrieb 1,5 kVAC / 50 VAC

Aufwärmzeit 5 Min.

Kommunikationsschnittstelle Loop Link

Signal- / Rauschverhältnis Min. 60 dB

Ansprechzeit (programmierbar) 1...60 s

EEProm Fehlerkontrolle < 3,5 s

Signaldynamik, Eingang 18 Bit

Signaldynamik, Ausgang 16 Bit

Kalibrierungstemperatur 20...28 °C

Genauigkeit, höherer Wert von allgemeinen und Grundwerten:

Allgemeine Werte		
Eingangsart	Absolute Genauigkeit	Temperatur- koeffizient
Alle	≤ ±0,05% d. Messsp.	≤ ±0,01% d. Messsp./°C

Grundwerte		
Eingangsart	Grund-Genauigkeit	Temperaturkoeffizient
Volt	$\leq \pm 10 \mu\text{V}$	$\leq \pm 1 \mu\text{V} / ^\circ\text{C}$
TE-Typ: E, J, K, L, N, T, U	$\leq \pm 1^\circ\text{C}$	$\leq \pm 0,05^\circ\text{C} / ^\circ\text{C}$
TE-Typ: B, R, S, W3, W5, LR	$\leq \pm 2^\circ\text{C}$	$\leq \pm 0,2^\circ\text{C} / ^\circ\text{C}$

EMV-Immunitätswirkung.....	< $\pm 0,5\%$ d. Messsp.
Erweiterte EMV-Immunität: NAMUR NE 21, A Kriterium, Burst.....	< $\pm 1\%$ d. Messsp.

Einfluss von Änderung der

Versorgungsspannung.....	< 0,005% d. Messsp. / VDC
Vibration.....	IEC 60068-2-6 : 2007
2...25 Hz.....	$\pm 1,6 \text{ mm}$
25...100 Hz.....	$\pm 4 \text{ g}$
Max. Leitungsquerschnitt.....	1 x 1,5 mm ² Litzendraht
Klemmschraubenanzugsmoment.....	0,4 Nm
Luftfeuchtigkeit.....	< 95% RF (nicht kond.)
Maß.....	$\varnothing 44 \times 20,2 \text{ mm}$
Schutzart (Gehäuse / Anschluss).....	IP68 / IP00
Gewicht.....	50 g

Elektrische Daten, Eingang:

Max. Nullpunktverschiebung (Offset)..... 50% des gewählten Maximalwertes

TE-Eingang:

Typ	Min. Temperatur	Max. Temperatur	Min. Spanne	Norm
B	+400°C	+1820°C	100°C	IEC584
E	-100°C	+1000°C	50°C	IEC584
J	-100°C	+1200°C	50°C	IEC584
K	-180°C	+1372°C	50°C	IEC584
L	-100°C	+900°C	50°C	DIN 43710
N	-180°C	+1300°C	50°C	IEC584
R	-50°C	+1760°C	100°C	IEC584
S	-50°C	+1760°C	100°C	IEC584
T	-200°C	+400°C	50°C	IEC584
U	-200°C	+600°C	50°C	DIN 43710
W3	0°C	+2300°C	100°C	ASTM E988-90
W5	0°C	+2300°C	100°C	ASTM E988-90
LR	-200°C	+800°C	50°C	GOST 3044-84

Vergleichstellenkompensation (CJC).....	< ±1,0°C
Fühlerfehlererkennung.....	Ja
Fühlerfehlerstrom:	
Bei Erkennung.....	Nom. 33 mA
Sonst.....	0 mA

Spannungseingang:

Messbereich.....	-12...150 mV
Min. Messbereich (Spanne).....	5 mV
Eingangswiderstand.....	10 MΩ

Ausgang:

Stromausgang:

Signalbereich.....	4...20 mA
Min. Signalbereich.....	16 mA
Aktualisierungszeit.....	440 ms
Ausgangssignal bei EEPROMfehler.....	≤ 3,5 mA
Belastungswiderstand.....	≤ (U _{Versorg.} - 7,2) / 0,023 [Ω]
Belastungsstabilität.....	< ±0,01% d. Messsp. / 100 Ω

Sensorfehlanzeige:

Programmierbar.....	3,5...23 mA
NAMUR NE43 aufsteuernd.....	23 mA
NAMUR NE43 zusteuernd.....	3,5 mA

d. Messspanne = der gewählten Messspanne

Zulassungen:

EMV.....	2014/30/EU
CCOE.....	P337392/1
RoHS.....	2011/65/EU
EAC.....	TR-CU 020/2011

Marine-Zulassung:

DNV-GL, Ships & Offshore.....	Standard for Certification No. 2.4
-------------------------------	------------------------------------

Ex:

ATEX 2014/34/EU	
5334A.....	KEMA 10ATEX0002 X
5334B.....	KEMA 06ATEX0062 X
IECEx.....	DEK 13.0035X
INMETRO.....	DEKRA 16.0013 X
CCOE.....	P337392/2
EAC Ex TR-CU 012/2011.....	RU C-DK.GB08.V.00410

ANSCHLÜSSE

Eingang:

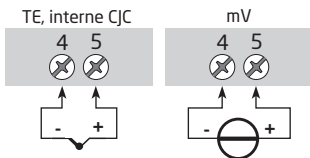

Ausgang:

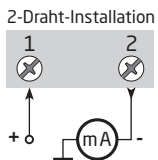

BLOCKDIAGRAMM

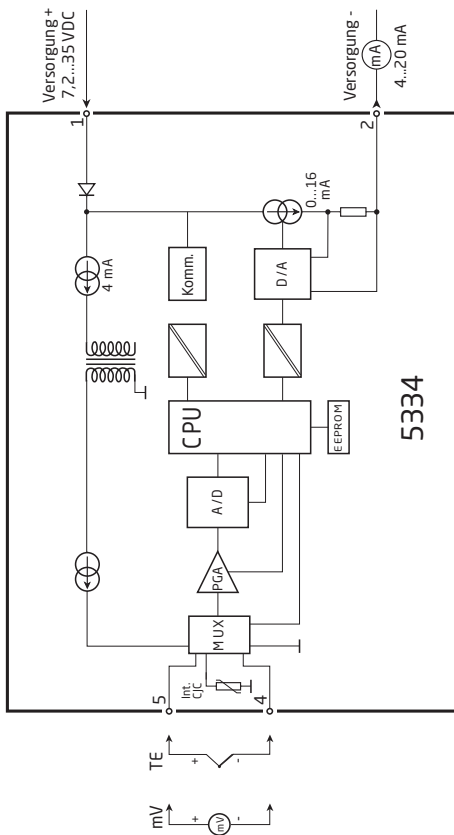

5334

PROGRAMMIERUNG

- Loop Link ist eine batteriegespeiste Schnittstelle zur Programmierung des 5334.
- Bezüglich Programmierung verweisen wir auf die nachfolgende Zeichnung und die "Hilfe"-Funktion im PReset-Programm.
- Loop Link darf nicht zur Kommunikation mit Geräten, die in Ex-gefährdeten Bereichen installiert sind, benutzt werden.

Bestellangabe: Loop Link

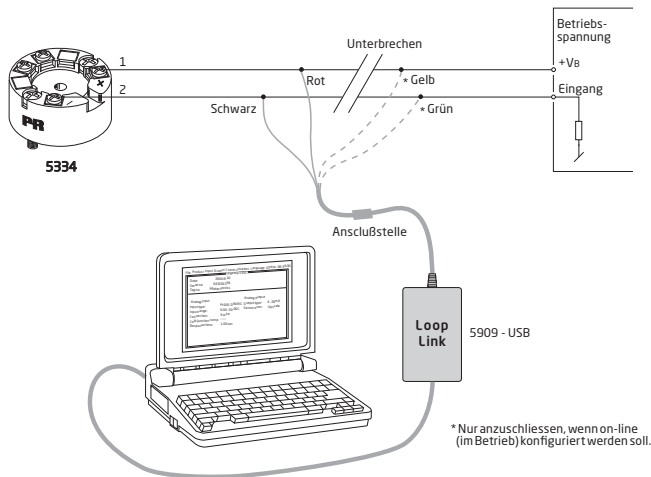

Abmessungen

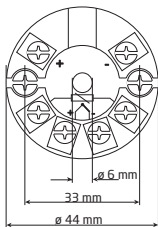

Montage von Fühlerleitungen

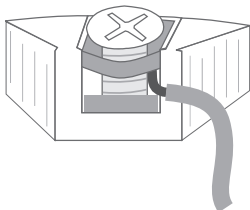
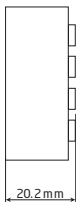

Die Leitungen müssen zwischen den Metallplatten montiert werden.

APPENDIX

ATEX INSTALLATION DRAWING - 5334A

ATEX INSTALLATION DRAWING - 5334B

IECE_x INSTALLATION DRAWING - 5334A

IECE_x INSTALLATION DRAWING - 5334B

INMETRO INSTRUÇÕES DE SEGURANÇA - 5334A

INMETRO INSTRUÇÕES DE SEGURANÇA - 5334B

ATEX Installationszeichnung

Für die sichere Installation von 5331A3B oder 5334A3B ist Folgendes zu beachten: Das Gerät darf nur von qualifiziertem Personal eingebaut werden, das mit den nationalen und internationalen Gesetzen, Richtlinien und Standards auf diesem Gebiet vertraut ist. Das Baujahr kann aus den ersten beiden Ziffern der Seriennummer ersehen werden.

ATEX-Zertifikat KEMA 10ATEX 0002 X

Markierung  II 3 G Ex nA [ic] IIC T4 ... T6 Gc
II 3 G Ex ic IIC T4...T6 Gc
II 3 D Ex ic IIIC Dc

Richtlinien EN 60079-0 : 2012, EN 60079-11 : 2012, EN 60079-15 : 2010

T4: $-40 \leq T_a \leq 85^\circ\text{C}$ T6: $-40 \leq T_a \leq 60^\circ\text{C}$	Klemme: 3,4,5,6 Ex nA [ic] Uo: 9,6 V Io: 25 mA Po: 60 mW Lo: 33 mH Co: 2,4 μF	Klemme: 1,2 Ex nA Umax. \leq 35 VDC	Klemme: 1,2 Ex ic Ui = 35 VDC Ii = 110 mA Li = 10 μH Ci = 1,0 nF
--	---	--	---

Sonderbedingungen für sichere Anwendung:

Für Zündschutzart Ex nA muss der Messumformer in einem Gehäuse, welcher einen Schutzgrad von mindestens IP 54 gemäß EN 60529 besitzt, eingebaut werden.

Für Anwendung in die Präsenz von entflammaren Staub, muss der Messumformer in einem Gehäuse, welcher einen Schutzgrad von mindestens IP 6X gemäß EN 60529 besitzt, eingebaut werden. Die Oberflächentemperatur des Gehäuses ist 20 K über der Umgebungstemperatur.

Bei einer Umgebungstemperatur $\geq 60^\circ\text{C}$ müssen hitzebeständige Leitungen eingesetzt werden, welche für eine mindestens 20 K höhere Umgebungstemperatur zugelassen sind.

ATEX Installationszeichnung



Für die sichere Installation von 5331D oder 5334B ist Folgendes zu beachten: Das Gerät darf nur von qualifiziertem Personal eingebaut werden, das mit den nationalen und internationalen Gesetzen, Richtlinien und Standards auf diesem Gebiet vertraut ist.

Das Baujahr kann aus den ersten beiden Ziffern der Seriennummer ersehen werden.

ATEX-Zertifikat KEMA 06ATEX 0062 X

Markierung  II 1 G Ex ia IIC T4...T6 Ga
II 1 D Ex ia IIIC Da
I M1 Ex ia I Ma

Richtlinien EN 60079-0 : 2012, EN 60079-11 : 2012, EN 60079-26 : 2007,
EN 60079-15 :2010

Ex-Bereich

Zone 0, 1, 2, 20, 21, 22

T4: $-40 \leq T_a \leq 85^\circ\text{C}$

T6: $-40 \leq T_a \leq 60^\circ\text{C}$

Klemme: 3,4,5,6

Uo: 9,6 VDC

Io: 25 mA

Po: 60 mW

Lo: 33 mH

Co: 2,4 μ F

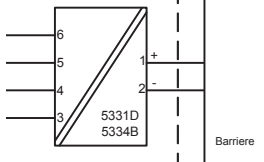

Klemme: 1,2

Ui: 30 VDC

Ii: 120 mA

Pi: 0,84 W

Li: 10 μ H

Ci: 1,0nF

Installationsvorschriften

Die galvanische Trennung zwischen dem Sensorkreis und dem Eingangskreis ist nicht unfehlbar. Allerdings ist die galvanische Trennung zwischen den Kreisen so ausgelegt, dass diese eine Testspannung von 500 VAC für eine Minute aushält.

Für Anwendung in einer potentiellen explosiven Atmosphäre - basierend auf entflammbares Gas - muss der Messumformer in einem Gehäuse, welcher einen Schutzgrad von mindestens IP20 gemäß EN 60529 besitzt, eingebaut werden.

Für Applikationen in explosiver Atmosphäre, wo Kategorie 1 G, 1 M oder 2 M Geräte vorgeschrieben sind, und wenn das Gehäuse aus Aluminium ist, ist das Gehäuse so zu montieren, dass Zündquellen (Stöße und Reibungsfunken) selbst bei selten auftretenden Störungen vermieden werden; wenn das Gehäuse aus nichtmetallischen Bestandteile ist, muss die elektrostatische Ladung der Gehäuse vermieden werden.

Für Anwendung in einer potentiellen explosiven Atmosphäre - basierend auf entflammbaren Staub - ist Folgendes zu beachten:

Der Messumformer muss in einem Metallkopf Form B gemäß DIN 43729 montiert werden. Das Gehäuse muss einen Schutzgrad von mindestens IP 6X gemäß EN 60529 besitzen und für den dementsprechenden Einsatz zugelassen werden.

Es dürfen nur Kabeleinführungen und Abdeckungen eingesetzt werden, welche für die jeweilige Anwendung zugelassen sind.

Bei einer Umgebungstemperatur $\geq 60^{\circ}\text{C}$ müssen hitzebeständige Leitungen eingesetzt werden, welche für eine mindestens 20 K höhere Umgebungstemperatur zugelassen sind.

Die Umgebungstemperatur der Gehäuse entspricht der Umgebungstemperatur plus 20K für eine Staubschicht mit einer Dicke von bis zu 5 mm.

IECEx Installation drawing



For safe installation of 5331A or 5334A the following must be observed. The module shall only be installed by qualified personnel who are familiar with the national and international laws, directives and standards that apply to this area.
Year of manufacture can be taken from the first two digits in the serial number.

Certificate	IECEx DEK 13.0035X
Marking	Ex nA [ic] IIC T4..T6 Gc Ex ic IIC T4..T6 Gc Ex ic IIIC Dc
Standards	IEC 60079-0 : 2011, IEC 60079-11 : 2011, IEC 60079-15 : 2010

T4: $-40 \leq T_a \leq 85^\circ\text{C}$
T6: $-40 \leq T_a \leq 60^\circ\text{C}$

Terminal: 3,4,5,6

Uo: 9.6 V
Io: 25 mA
Po: 60 mW
Lo: 33 mH
Co: 2.4 μF

Terminal: 1,2

Ex nA
Umax = 35 VDC

Terminal: 1,2

Ex ic
Ui = 35 VDC
Ii = 110 mA
Li = 10 μH
Ci = 1.0 nF

Installation note:

For installation in a potentially explosive gas atmosphere, the following instructions apply:
For nA installation the transmitter must be installed in an metal enclosure, e.g. a form B enclosure providing a degree of protection of at least IP54 according to IEC60529 or in an enclosure with type of protection Ex n or Ex e.

For ic installation the transmitter must be installed in enclosure providing a degree of protection of at least IP20 according to IEC60529 and that is suitable for the application.

Cable entry devices and blanking elements shall fulfill the same requirements
For an ambient temperature $\geq 60^\circ\text{C}$, heat resistant cables shall be used with a rating of at least 20 K above the ambient temperature.

For installation in a potentially explosive dust atmosphere, the following instructions apply:
The surface temperature of the enclosure is equal to the ambient temperature plus 20 K, for a dust layer with a thickness up to 5 mm.
The transmitter must be mounted in a enclosure according to DIN 43729 that provides a degree of protection of at least IP6X according to IEC60529, and that is suitable for the application. Cable entry devices and blanking elements shall fulfill the same requirements.

IECEx Installation drawing



For safe installation of 5331D or 5334B the following must be observed. The module shall only be installed by qualified personnel who are familiar with the national and international laws, directives and standards that apply to this area.

Year of manufacture can be taken from the first two digits in the serial number.

Certificate	IECEx DEK 13.0035X
Marking	Ex ia IIC T4...T6 Ga Ex ia IIIC Da Ex ia I Ma
Standards	IEC 60079-0 : 2011, IEC 60079-11 : 2011, IEC 60079-26:2006

Hazardous area

Zone 0, 1, 2, 20, 21, 22, M1

T4: $-40 \leq T_a \leq 85^\circ\text{C}$

T5: $-40 \leq T_a \leq 60^\circ\text{C}$

T6: $-40 \leq T_a \leq 45^\circ\text{C}$

Terminal: 3,4,5,6

U_o: 9.6 VDC

I_o: 25 mA

P_o: 60 mW

L_o: 33 mH

C_o: 2.4 μF

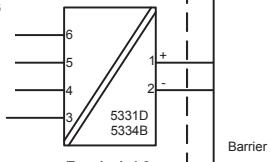

Terminal: 1,2

U_i: 30 VDC

I_i: 120 mA

P_i: 0.84 W

L_i: 10 μH

C_i: 1.0 nF

Installation notes.

The sensor circuit is not infallibly galvanic isolated from the input circuit. However, the galvanic isolation between the circuits is capable of withstanding a test voltage of 500Vac during 1 minute.

In a potentially explosive gas atmosphere, the transmitter shall be mounted in a metal form B enclosure in order to provide a degree of protection of at least IP20 according to IEC60529. If however the environment requires a higher degree of protection, this shall be taken into account.

If the transmitter is installed in an explosive atmosphere requiring the use of equipment protection level Ga, Ma and Mb, and if the enclosure is made of aluminum, it must be installed such, that ignition sources due to impact and friction sparks are excluded.

For installation in a potentially explosive dust atmosphere, the following instructions apply:

For explosive dust atmospheres, the surface temperature of the outer enclosure is 20 K above the ambient temperature.

The transmitter shall be mounted in a metal enclosure form B according to DIN43729 that is providing a degree of protection of at least IP6X according to IEC60529, that is suitable for the application and correctly installed.

Cable entries and blanking elements shall be used that are suitable for the application and correctly installed.

For an ambient temperature $\geq 60^{\circ}\text{C}$, heat resistant cables shall be used with a rating of at least 20 K above the ambient temperature.

Desenho de Instalação INMETRO



Para instalação segura do 5331A ou 5334A o seguinte deve ser observado. O modelo deve apenas ser instalado por pessoas qualificadas que são familiarizadas com as leis nacionais e internacionais, diretrizes e padrões que se aplicam a esta área.

O ano de fabricação pode ser pego dos dois primeiros dígitos do número de série.

Certificado DEKRA 16.0013 X

Marcas Ex nA [ic] IIC T4..T6 Gc
Ex ic IIC T4..T6 Gc
Ex ic IIC Dc

Normas ABNT NBR IEC 60079-0 : 2013; ABNT NBR IEC 60079-11 : 2013
ABNT NBR IEC60079-15 : 2012

T4: $-40 \leq T_a \leq 85^\circ\text{C}$	Terminais:	Terminais: 1,2	Terminais: 1,2
T6: $-40 \leq T_a \leq 60^\circ\text{C}$	3,4,5,6	Ex nA	Ex ic
	Uo: 9,6 V		
	Io: 25 mA	U ≤ 35 VDC	Ui = 35 VDC
	Po: 60 mW		Ii = 110 mA
	Lo: 33 mH		Li = 10 μH
	Co: 2,4 μF		Ci = 1,0 nF

Notas para instalação

Para a instalação em uma atmosfera de gás potencialmente explosivo, aplicam-se as instruções a seguir:

Para a instalação nA o transmissor deve ser instalado em um invólucro de metal, por exemplo, gabinete em forma B que forneça um grau de proteção de pelo menos IP54 de acordo com ABNT NBR IEC60529 ou em um invólucro com tipo de proteção Ex n ou Ex e.

Para a instalação Ex ic o transmissor deve ser instalado em um invólucro proporcionando um grau de proteção IP20 de acordo com a norma ABNT NBR IEC60529. E o invólucro deve, pelo menos, ser adequado para a aplicação e corretamente instalado.

Dispositivos de entrada de cabos e elementos de supressão devem cumprir os mesmos requisitos.

Para temperatura ambiente $\geq 60^\circ\text{C}$, fios de resistência ao calor devem ser usados com uma faixa de pelo menos 20K acima da temperatura ambiente.

Para a instalação em uma atmosfera de poeira potencialmente explosiva, aplicam-se as instruções a seguir:

O transmissor deve ser montado em invólucro de metal forma B de acordo com DIN43729 que está fornecendo pelo menos um grau de proteção IP6X de acordo com ABNT NBR IEC60529.

O invólucro deve ser adequado para aplicação e instalado corretamente.

As entradas dos cabos e os elementos de obtenção que podem ser utilizados devem ser adequados à aplicação pretendida e corretamente instalados.

A temperatura da superfície do invólucro é igual à temperatura ambiente mais 20 K, para uma camada de pó, com uma espessura de até 5 mm.

Desenho de Instalação INMETRO



Para instalação segura do 5331D ou 5334B o seguinte deve ser observado. O modelo deve apenas ser instalado por pessoas qualificadas que são familiarizadas com as leis nacionais e internacionais, diretrizes e padrões que se aplicam a esta área.
O ano de fabricação pode ser pego dos dois primeiros dígitos do número de série.

CertificadoDEKRA 16.0013 X

Marcas Ex ia IIC T6...T4 Ga
 Ex ia IIIC Da

Normas ABNT NBR IEC 60079-0: 2013; ABNT NBR IEC 60079-11: 2013

Áreas classificadas

Zona 0, 1, 2, 20, 21, 22,

T4: $-40 \leq T_a \leq 85^{\circ}\text{C}$

T5: $-40 \leq T_a \leq 60^{\circ}\text{C}$

T6: $-40 \leq T_a \leq 45^{\circ}\text{C}$

Terminais 3,4,5,6

Uo: 9,6 VDC

Io: 25 mA

Po: 60 mW

Lo: 33 mH

Co: 2,4 μ F

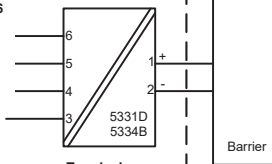

Terminais:

1,2

Ui: 30 VDC

Ii: 120 mA

Pi: 0,84 W

Li: 10 μ H

Ci: 1,0nF

Notas de instalação

O circuito do sensor não é isolado galvanicamente do circuito de entrada de forma infalível. Contudo, a isolação galvânica entre os circuitos é capaz de resistir a um ensaio de tensão de 500Vac durante 1 minuto.

Em uma atmosfera de gás potencialmente explosiva, o transmissor deve ser montado em um invólucro a fim de garantir um grau de proteção de no mínimo IP20 de acordo com a ABNT NBR IEC60529. Se contudo, o ambiente necessitar de um nível de proteção maior, isso deve ser levado em consideração.

Se o transmissor é instalado em uma atmosfera explosiva exigindo o uso de equipamento de proteção de nível Ga e se o invólucro é feito de alumínio, ele deve ser instalado de modo que, mesmo em caso remoto de avaria, fontes de ignição devido ao impacto e fricção, faíscas são eliminadas.

Se o invólucro é feito de materiais não metálicos, cargas eletrostáticas devem ser evitadas.

Para instalação em atmosfera de poeira potencialmente explosiva, as instruções a seguir são aplicáveis:

O transmissor deve ser montado em invólucro de metal forma B de acordo com DIN43729 que está fornecendo um grau de proteção de pelo menos IP6X de acordo com ABNT NBR IEC60529. O invólucro deve ser adequado para aplicação pretendida e instalado corretamente.

As entradas dos cabos e os elementos de obturação que podem ser utilizados devem ser adequados à aplicação pretendida e corretamente instalados.

Para temperatura ambiente $\geq 60^{\circ}\text{C}$, fios de resistência ao calor devem ser usados com uma faixa de pelo menos 20K acima da temperatura ambiente.

A temperatura da superfície do invólucro é igual à temperatura ambiente mais 20 K, por uma camada de pó, com espessura de até 5 mm.



Displays Programmable displays with a wide selection of inputs and outputs for display of temperature, volume and weight, etc. Feature linearization, scaling, and difference measurement functions for programming via PReset software.



Ex interfaces Interfaces for analog and digital signals as well as HART signals between sensors / I/P converters / frequency signals and control systems in Ex zone 0, 1 & 2 and for some devices in zone 20, 21 & 22.



Isolation Galvanic isolators for analog and digital signals as well as HART signals. A wide product range with both loop-powered and universal isolators featuring linearization, inversion, and scaling of output signals.



Temperature A wide selection of transmitters for DIN form B mounting and DIN rail devices with analog and digital bus communication ranging from application-specific to universal transmitters.



Universal PC or front programmable devices with universal options for input, output and supply. This range offers a number of advanced features such as process calibration, linearization and auto-diagnosis.





www.preelectronics.fr
sales-fr@preelectronics.com



www.preelectronics.de
sales-de@preelectronics.com



www.preelectronics.es
sales-es@preelectronics.com



www.preelectronics.it
sales-it@preelectronics.com



www.preelectronics.se
sales-se@preelectronics.com



www.preelectronics.com
sales-uk@preelectronics.com



www.preelectronics.com
sales-us@preelectronics.com



www.preelectronics.cn
sales-cn@preelectronics.com

Head office

Denmark
PR electronics A/S
Lerbakken 10
DK-8410 Rønne

www.preelectronics.com
sales@preelectronics.dk
tel. +45 86 37 26 77
fax +45 86 37 30 85