

PR
electronics



5 3 3 4

**2-tråds programmerbar
transmitter**

Nr. 5334V110-DK
Fra serienr. 141365001



CCOE **Ex** EAC **CE**

Revision Notes

The following list provides notes concerning revisions of this document.

Rev. ID	Date	Notes
108	13/45	IECEX and INMETRO approvals added
109	15/14	PESO/CCOE approval added GOST approval replaced with EAC approval
115	17/07	INMETRO installation drawings updated

2-TRÅDS PROGRAMMERBAR TRANSMITTER

5334

INDHOLDSFORTEGNELSE

Anvendelse.....	2
Teknisk karakteristik	2
Montage / installation.....	2
Applikationer	3
Bestillingsskema: 5334.....	4
Elektriske specifikationer	4
Tilslutninger.....	7
Blokdiagram	8
Programmering	9
Mekaniske specifikationer.....	10
Montering af følerledninger	10
Appendix	11
ATEX Installation Drawing - 5334A	12
ATEX Installation Drawing - 5334B	13
IECEX Installation Drawing - 5334A.....	15
IECEX Installation Drawing - 5334B.....	16
INMETRO Instruções de Segurança - 5334A.....	18
INMETRO Instruções de Segurança - 5334B.....	19

2-TRÅDS PROGRAMMERBAR TRANSMITTER 5334

- *Indgang for TC*
- *Høj målenøjagtighed*
- *Galvanisk isolation*
- *Programmerbar følerfejlsværdi*
- *Kan monteres i DIN form B følerhoved*

Anvendelse

- Temperaturlineariseret måling med termoelementføler.
- Forstærkning af bipolære mV-signaler eventuelt lineariseret efter defineret lineariseringsfunktion til et 4...20 mA signal.

Teknisk karakteristik

- PR5334 kan af brugeren i løbet af få sekunder programmeres til at måle inden for alle normerede TC-temperaturområder.
- CJC-kompensering med indbygget temperaturføler.
- Der er løbende sikkerhedscheck af gemte data.

Montage / installation

- Kan monteres i DIN form B følerhoved. I ikke-eksplosionsfarlige områder kan 5334 monteres på en DIN-skinne med PR-beslag type 8421.

APPLIKATIONER

TC til 4...20 mA

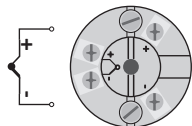

2-trådsinstallation
i kontrolrum

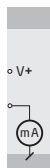

mV til 4...20 mA

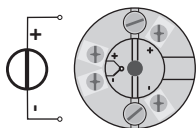

2-trådsinstallation
i kontrolrum

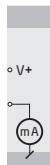

Bestillingsskema: 5334

Type	Version	Omgivelses-temperatur	Galvanisk isolation
5334	Standard : A ATEX Ex, IECEx & INMETRO : B	-40°C...+85°C : 3	1500 VAC : B

Elektriske specifikationer

Specifikationsområde:

-40°C til +85°C

Fælles specifikationer:

Forsyningsspænding DC

Standard..... 7,2...35 V

ATEX Ex, IECEx & INMETRO..... 7,2...30 VDC

Internt effekttab

Standard..... 25 mW...0,8 W

CSA, FM, ATEX, IECEx & INMETRO..... 25 mW...0,7 W

Spændingsdrop..... 7,2 VDC

Isolationsspænding, test / drift..... 1,5 kVAC / 50 VAC

Opvarmningstid 5 min.

Kommunikationsinterface Loop Link

Signal- / støjforhold Min. 60 dB

Reaktionstid (programmerbar) 1...60 s

EEPROM fejlcheck..... < 3,5 s

Signaldynamik, indgang..... 18 bit

Signaldynamik, udgang..... 16 bit

Kalibreringstemperatur 20...28°C

Nøjagtighed, størst af generelle og basisværdier:

Generelle værdier		
Indgangstype	Absolut nøjagtighed	Temperaturkoefficient
Alle	$\leq \pm 0,05\%$ af span	$\leq \pm 0,005\%$ af span / °C

Basisværdier		
Indgangstype	Basisnøjagtighed	Temperaturkoefficient
Volt	$\leq \pm 10 \mu\text{V}$	$\leq \pm 1 \mu\text{V} / ^\circ\text{C}$
TC-type: E, J, K, L, N, T, U	$\leq \pm 1^\circ\text{C}$	$\leq \pm 0,05^\circ\text{C} / ^\circ\text{C}$
TC-type: B, R, S, W3, W5, LR	$\leq \pm 2^\circ\text{C}$	$\leq \pm 0,2^\circ\text{C} / ^\circ\text{C}$

EMC-immunitetspåvirkning.....	$< \pm 0,5\%$ af span
Udvidet EMC-immunitet: NAMUR NE 21, A-kriterium, gniststøj.....	$< \pm 1\%$ af span

Virkning af forsyningsspændingsændring....	$< 0,005\%$ af span / VDC
Vibration.....	IEC 60068-2-6 : 2007
2...25 Hz.....	$\pm 1,6 \text{ mm}$
25...100 Hz.....	$\pm 4 \text{ g}$
Max. ledningskvadrat.....	1 x 1,5 mm ² flerkoret ledning
Klemskruetilspændingsmoment.....	0,4 Nm
Luftfugtighed.....	$< 95\%$ RH (ikke kond.)
Mål.....	$\varnothing 44 \times 20,2 \text{ mm}$
Kapslingsklasse (hus / klemme).....	IP68 / IP00
Vægt.....	50 g

Elektriske specifikationer indgang:

Max. nulpunktsforskydning (offset)..... 50% af valgt max. værdi

TC-indgang:

Type	Min. temperatur	Max. temperatur	Min. span	Standard
B	+400°C	+1820°C	100°C	IEC584
E	-100°C	+1000°C	50°C	IEC584
J	-100°C	+1200°C	50°C	IEC584
K	-180°C	+1372°C	50°C	IEC584
L	-100°C	+900°C	50°C	DIN 43710
N	-180°C	+1300°C	50°C	IEC584
R	-50°C	+1760°C	100°C	IEC584
S	-50°C	+1760°C	100°C	IEC584
T	-200°C	+400°C	50°C	IEC584
U	-200°C	+600°C	50°C	DIN 43710
W3	0°C	+2300°C	100°C	ASTM E988-90
W5	0°C	+2300°C	100°C	ASTM E988-90
LR	-200°C	+800°C	50°C	GOST 3044-84

Koldt loddestedskomp. (CJC).....	< ±1,0°C
Følerfejsdetektering.....	Ja
Følerfejsstrøm:	
under detektering.....	Nom. 33 mA
ellers.....	0 mA

Spændingsindgang:

Måleområde	-12...150 mV
Min. måleområde (span).....	5 mV
Indgangsmodstand	10 MΩ

Udgang:

Strømodgang:

Signalområde.....	4...20 mA
Min. signalområde.....	16 mA
Opdateringstid	440 ms
Udgangssignal ved EEpromfejl.....	≤ 3,5 mA
Belastningsmodstand	≤ (V _{forsyn.} - 7,2) / 0,023 [Ω]
Belastningsstabilitet	< ±0,01% af span / 100 Ω

Følerfejsdetektering:

Programmerbar	3,5...23 mA
NAMUR NE43 Upscale.....	23 mA
NAMUR NE43 Downscale.....	3,5 mA

Af span = Af det aktuelt valgte område

Godkendelser:

EMC.....	2014/30/EU
CCOE	P337392/1
RoHS	2011/65/EU
EAC.....	TR-CU 020/2011

Marine-godkendelse:

DNV-GL, Ships & Offshore.....	Standard for Certification No. 2.4
-------------------------------	------------------------------------

Ex:

ATEX 2014/34/EU	
5334A.....	KEMA 10ATEX0002 X
5334B.....	KEMA 06ATEX0062 X
IECEX	DEK 13.0035X
INMETRO	DEKRA 16.0013 X
CCOE	P337392/2
EAC Ex TR-CU 012/2011	RU C-DK.GB08.V.00410

TILSLUTNINGER

Indgang:

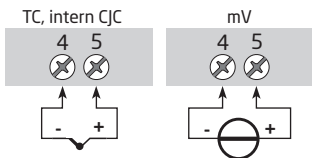

Udgang:

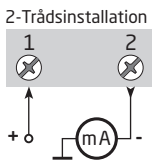

BLOKDIAGRAM

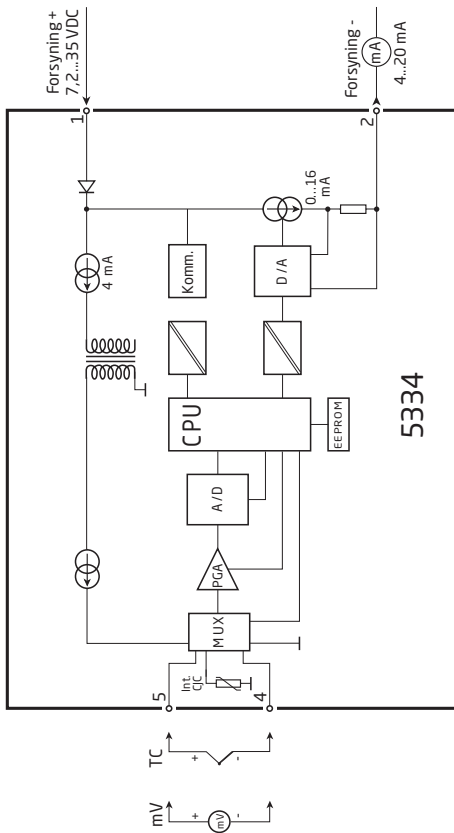

PROGRAMMERING

- Loop Link er et batteridrevet kommunikationsinterface, der er nødvendigt for programmering af 5334.
- Ved programmering henvises til tegningen nedenfor og hjælpefunktionen i PReset programmet.
- Loop Link må ikke benyttes til kommunikation med moduler installeret i Ex-område.

Bestilling: Loop Link

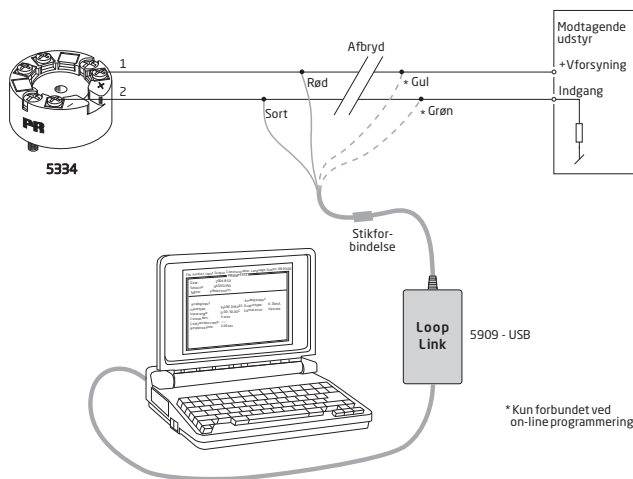

Mekaniske specifikationer

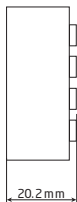
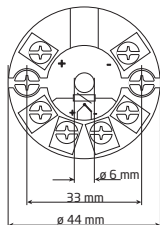

Montering af følerledninger

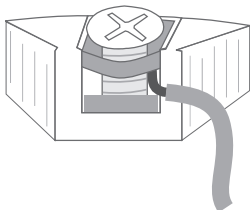

Ledninger monteres mellem metalpladerne

APPENDIX

ATEX INSTALLATION DRAWING - 5334A

ATEX INSTALLATION DRAWING - 5334B

IECE_x INSTALLATION DRAWING - 5334A

IECE_x INSTALLATION DRAWING - 5334B

INMETRO INSTRUÇÕES DE SEGURANÇA - 5334A

INMETRO INSTRUÇÕES DE SEGURANÇA - 5334B

ATEX Installationstegning

For sikker installation af 5331A3B eller 5334A3B skal følgende overholdes: Modulet må kun installeres af kvalificerede personer, som er bekendt med national og international lovgivning, direktiver og standarder i det land, hvor modulet skal installeres.

Produktionsår fremgår af de to første cifre i serienummeret.

ATEX-certifikat KEMA 10ATEX 0002 X

Mærkning  II 3 G Ex nA [ic] IIC T4 ... T6 Gc
II 3 G Ex ic IIC T4...T6 Gc
II 3 D Ex ic IIIC Dc

Standarder EN 60079-0 : 2012, EN 60079-11 : 2012, EN 60079-15 : 2010

T4: $-40 \leq T_a \leq 85^{\circ}\text{C}$
T6: $-40 \leq T_a \leq 60^{\circ}\text{C}$

Klemme: 3,4,5,6
Ex nA [ic]

Klemme: 1,2
Ex nA

Klemme: 1,2
Ex ic

Uo: 9,6 V
Io: 25 mA
Po: 60 mW
Lo: 33 mH
Co: 2,4 μF

Umax. \leq 35 VDC

Ui = 35 VDC
Ii = 110 mA
Li = 10 μH
Ci = 1,0 nF

Særlige betingelser for sikker anvendelse:

For beskyttelsestype Ex nA skal transmitteren monteres i et hus med en tæthedegrad på mindst IP54 i overensstemmelse med EN 60529.

Ved installationer i områder med potentiel eksplosionsfare på grund af brændbart støv, skal transmitteren monteres i et hus med en tæthedegrad på mindst IP6X i overensstemmelse med EN 60529. Husets overfladetemperatur er 20 K over omgivelsestemperaturen.

Hvis omgivelsestemperaturen $\geq 60^{\circ}\text{C}$, skal der bruges varmebestandige kabler med specifikationer på mindst 20K over omgivelsestemperaturen.

ATEX Installationstegning



For sikker installation af 5331D eller 5334B skal følgende overholdes: Modulet må kun installeres af kvalificerede personer, som er bekendt med national og international lovgivning, direktiver og standarder i det land, hvor modulet skal installeres.

Produktionsår fremgår af de to første cifre i serienummeret.

ATEX-certifikat KEMA 06ATEX 0062 X

Mærkning  II 1 G Ex ia IIC T4...T6 Ga
II 1 D Ex ia IIC Da
I M1 Ex ia I Ma

Standarder EN 60079-0 : 2012, EN 60079-11 : 2012, EN 60079-26 : 2007,
EN 60079-15 :2010

Ex-område

Zone 0, 1, 2, 20, 21, 22

T4: $-40 \leq T_a \leq 85^\circ\text{C}$

T6: $-40 \leq T_a \leq 60^\circ\text{C}$

Klemme: 3,4,5,6

Uo: 9,6 VDC

Io: 25 mA

Po: 60 mW

Lo: 33 mH

Co: 2,4 μ F

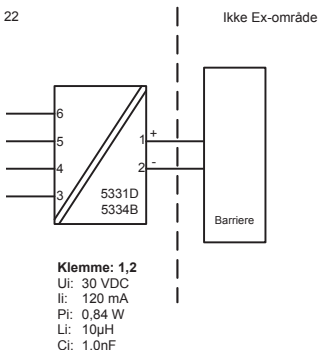

Installationsforskrifter

Følerkredsløbet er ikke ufejlbarligt galvanisk isoleret fra indgangskredsløbet, men den galvaniske isolation mellem kredsene kan modstå en testspænding på 500 VAC i 1 minut.

I områder med potential eksplosionsfare på grund af brændbar gas skal transmitteren installeres i et hus med en kapslingsklasse på mindst IP20 i overensstemmelse med EN60529.

Hvis transmitteren installeres i eksplosive atmosfærer, hvor kategori 1 G, 1 M eller 2 M udstyr er krævet, og hvis huset er lavet af aluminium, skal det installeres således, at der selv ved sjældent opstående hændelser ikke er risiko for antændelse på grund af stød og friktionsgnister; hvis huset er lavet af ikke-metallisk materiale, skal elektrostatiske ladninger på transmitterens hus undgås.

For installation i områder med potentiel eksplosionsfare på grund af brændbart støv skal følgende overholdes:

Transmitteren skal monteres i et form B metalhus i overensstemmelse med DIN 43729. Huset skal have en tæthedegrad på mindst IP 6X i overensstemmelse med EN 60529 og skal være egnet til den pågældende applikation samt være installeret korrekt.

Der må kun anvendes kabelforskrutninger og blindstik, som egner sig til den pågældende applikation og som installeres korrekt.

Hvis omgivelsestemperaturen $\geq 60^{\circ}\text{C}$, skal der bruges varmebestandige kabler med specifikationer på mindst 20K over omgivelsestemperaturen.

Husets overfladetemperatur er lig med den maksimale omgivelsestemperatur plus 20 K for støvlæg med en tykkelse på op til 5 mm.

IECEx Installation drawing



For safe installation of 5331A or 5334A the following must be observed. The module shall only be installed by qualified personnel who are familiar with the national and international laws, directives and standards that apply to this area.
Year of manufacture can be taken from the first two digits in the serial number.

Certificate	IECEx DEK 13.0035X
Marking	Ex nA [ic] IIC T4..T6 Gc Ex ic IIC T4..T6 Gc Ex ic IIIC Dc
Standards	IEC 60079-0 : 2011, IEC 60079-11 : 2011, IEC 60079-15 : 2010

T4: $-40 \leq T_a \leq 85^\circ\text{C}$
T6: $-40 \leq T_a \leq 60^\circ\text{C}$

Terminal: 3,4,5,6

Uo: 9.6 V
Io: 25 mA
Po: 60 mW
Lo: 33 mH
Co: 2.4 μF

Terminal: 1,2

Ex nA
Umax = 35 VDC

Terminal: 1,2

Ex ic
Ui = 35 VDC
Ii = 110 mA
Li = 10 μH
Ci = 1.0 nF

Installation note:

For installation in a potentially explosive gas atmosphere, the following instructions apply:
For nA installation the transmitter must be installed in an metal enclosure, e.g. a form B enclosure providing a degree of protection of at least IP54 according to IEC60529 or in an enclosure with type of protection Ex n or Ex e.

For ic installation the transmitter must be installed in enclosure providing a degree of protection of at least IP20 according to IEC60529 and that is suitable for the application.

Cable entry devices and blanking elements shall fulfill the same requirements
For an ambient temperature $\geq 60^\circ\text{C}$, heat resistant cables shall be used with a rating of at least 20 K above the ambient temperature.

For installation in a potentially explosive dust atmosphere, the following instructions apply:
The surface temperature of the enclosure is equal to the ambient temperature plus 20 K, for a dust layer with a thickness up to 5 mm.
The transmitter must be mounted in a enclosure according to DIN 43729 that provides a degree of protection of at least IP6X according to IEC60529, and that is suitable for the application. Cable entry devices and blanking elements shall fulfill the same requirements.

IECEx Installation drawing



For safe installation of 5331D or 5334B the following must be observed. The module shall only be installed by qualified personnel who are familiar with the national and international laws, directives and standards that apply to this area.

Year of manufacture can be taken from the first two digits in the serial number.

Certificate	IECEx DEK 13.0035X
Marking	Ex ia IIC T4...T6 Ga Ex ia IIIC Da Ex ia I Ma
Standards	IEC 60079-0 : 2011, IEC 60079-11 : 2011, IEC 60079-26:2006

Hazardous area

Zone 0, 1, 2, 20, 21, 22, M1

T4: $-40 \leq T_a \leq 85^\circ\text{C}$

T5: $-40 \leq T_a \leq 60^\circ\text{C}$

T6: $-40 \leq T_a \leq 45^\circ\text{C}$

Terminal: 3,4,5,6

U_o: 9.6 VDC

I_o: 25 mA

P_o: 60 mW

L_o: 33 mH

C_o: 2.4 μF

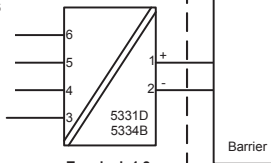

Terminal: 1,2

U_i: 30 VDC

I_i: 120 mA

P_i: 0.84 W

L_i: 10 μH

C_i: 1.0 nF

Installation notes.

The sensor circuit is not infallibly galvanic isolated from the input circuit. However, the galvanic isolation between the circuits is capable of withstanding a test voltage of 500Vac during 1 minute.

In a potentially explosive gas atmosphere, the transmitter shall be mounted in a metal form B enclosure in order to provide a degree of protection of at least IP20 according to IEC60529. If however the environment requires a higher degree of protection, this shall be taken into account.

If the transmitter is installed in an explosive atmosphere requiring the use of equipment protection level Ga, Ma and Mb, and if the enclosure is made of aluminum, it must be installed such, that ignition sources due to impact and friction sparks are excluded.

For installation in a potentially explosive dust atmosphere, the following instructions apply:

For explosive dust atmospheres, the surface temperature of the outer enclosure is 20 K above the ambient temperature.

The transmitter shall be mounted in a metal enclosure form B according to DIN43729 that is providing a degree of protection of at least IP6X according to IEC60529, that is suitable for the application and correctly installed.

Cable entries and blanking elements shall be used that are suitable for the application and correctly installed.

For an ambient temperature $\geq 60^{\circ}\text{C}$, heat resistant cables shall be used with a rating of at least 20 K above the ambient temperature.

Desenho de Instalação INMETRO



Para instalação segura do 5331A ou 5334A o seguinte deve ser observado. O modelo deve apenas ser instalado por pessoas qualificadas que são familiarizadas com as leis nacionais e internacionais, diretrizes e padrões que se aplicam a esta área.

O ano de fabricação pode ser pego dos dois primeiros dígitos do número de série.

Certificado DEKRA 16.0013 X

Marcas
 Ex nA [ic] IIC T4..T6 Gc
 Ex ic IIC T4..T6 Gc
 Ex ic IIC Dc

Normas ABNT NBR IEC 60079-0 : 2013; ABNT NBR IEC 60079-11 : 2013
 ABNT NBR IEC60079-15 : 2012

T4: $-40 \leq T_a \leq 85^\circ\text{C}$	Terminais:	Terminais: 1,2	Terminais: 1,2
T6: $-40 \leq T_a \leq 60^\circ\text{C}$	3,4,5,6	Ex nA	Ex ic
	Uo: 9,6 V		
	Io: 25 mA	U ≤ 35 VDC	Ui = 35 VDC
	Po: 60 mW		Ii = 110 mA
	Lo: 33 mH		Li = 10 μH
	Co: 2,4 μF		Ci = 1,0 nF

Notas para instalação

Para a instalação em uma atmosfera de gás potencialmente explosivo, aplicam-se as instruções a seguir:

Para a instalação nA o transmissor deve ser instalado em um invólucro de metal, por exemplo, gabinete em forma B que forneça um grau de proteção de pelo menos IP54 de acordo com ABNT NBR IEC60529 ou em um invólucro com tipo de proteção Ex n ou Ex e.

Para a instalação Ex ic o transmissor deve ser instalado em um invólucro proporcionando um grau de proteção IP20 de acordo com a norma ABNT NBR IEC60529. E o invólucro deve, pelo menos, ser adequado para a aplicação e corretamente instalado.

Dispositivos de entrada de cabos e elementos de supressão devem cumprir os mesmos requisitos.

Para temperatura ambiente $\geq 60^\circ\text{C}$, fios de resistência ao calor devem ser usados com uma faixa de pelo menos 20K acima da temperatura ambiente.

Para a instalação em uma atmosfera de poeira potencialmente explosiva, aplicam-se as instruções a seguir:

O transmissor deve ser montado em invólucro de metal forma B de acordo com DIN43729 que está fornecendo pelo menos um grau de proteção IP6X de acordo com ABNT NBR IEC60529.

O invólucro deve ser adequado para aplicação e instalado corretamente.

As entradas dos cabos e os elementos de obtenção que podem ser utilizados devem ser adequados à aplicação pretendida e corretamente instalados.

A temperatura da superfície do invólucro é igual à temperatura ambiente mais 20 K, para uma camada de pó, com uma espessura de até 5 mm.

Desenho de Instalação INMETRO



Para instalação segura do 5331D ou 5334B o seguinte deve ser observado. O modelo deve apenas ser instalado por pessoas qualificadas que são familiarizadas com as leis nacionais e internacionais, diretrizes e padrões que se aplicam a esta área.
O ano de fabricação pode ser pego dos dois primeiros dígitos do número de série.

CertificadoDEKRA 16.0013 X

Marcas Ex ia IIC T6...T4 Ga
 Ex ia IIIC Da

Normas ABNT NBR IEC 60079-0: 2013; ABNT NBR IEC 60079-11: 2013

Áreas classificadas

Zona 0, 1, 2, 20, 21, 22,

T4: $-40 \leq T_a \leq 85^{\circ}\text{C}$

T5: $-40 \leq T_a \leq 60^{\circ}\text{C}$

T6: $-40 \leq T_a \leq 45^{\circ}\text{C}$

Terminais 3,4,5,6

Uo: 9,6 VDC

Io: 25 mA

Po: 60 mW

Lo: 33 mH

Co: 2,4 μ F

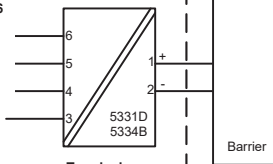

Terminais:

1,2

Ui: 30 VDC

Ii: 120 mA

Pi: 0,84 W

Li: 10 μ H

Ci: 1,0nF

Notas de instalação

O circuito do sensor não é isolado galvanicamente do circuito de entrada de forma infalível. Contudo, a isolamento galvânica entre os circuitos é capaz de resistir a um ensaio de tensão de 500Vac durante 1 minuto.

Em uma atmosfera de gás potencialmente explosiva, o transmissor deve ser montado em um invólucro a fim de garantir um grau de proteção de no mínimo IP20 de acordo com a ABNT NBR IEC60529. Se contudo, o ambiente necessitar de um nível de proteção maior, isso deve ser levado em consideração.

Se o transmissor é instalado em uma atmosfera explosiva exigindo o uso de equipamento de proteção de nível Ga e se o invólucro é feito de alumínio, ele deve ser instalado de modo que, mesmo em caso remoto de avaria, fontes de ignição devido ao impacto e fricção, faíscas são eliminadas.

Se o invólucro é feito de materiais não metálicos, cargas eletrostáticas devem ser evitadas.

Para instalação em atmosfera de poeira potencialmente explosiva, as instruções a seguir são aplicáveis:

O transmissor deve ser montado em invólucro de metal forma B de acordo com DIN43729 que está fornecendo um grau de proteção de pelo menos IP6X de acordo com ABNT NBR IEC60529. O invólucro deve ser adequado para aplicação pretendida e instalado corretamente.

As entradas dos cabos e os elementos de obturação que podem ser utilizados devem ser adequados à aplicação pretendida e corretamente instalados.

Para temperatura ambiente $\geq 60^{\circ}\text{C}$, fios de resistência ao calor devem ser usados com uma faixa de pelo menos 20K acima da temperatura ambiente.

A temperatura da superfície do invólucro é igual à temperatura ambiente mais 20 K, por uma camada de pó, com espessura de até 5 mm.



Displays Programmable displays with a wide selection of inputs and outputs for display of temperature, volume and weight, etc. Feature linearization, scaling, and difference measurement functions for programming via PReset software.



Ex interfaces Interfaces for analog and digital signals as well as HART signals between sensors / I/P converters / frequency signals and control systems in Ex zone 0, 1 & 2 and for some devices in zone 20, 21 & 22.



Isolation Galvanic isolators for analog and digital signals as well as HART signals. A wide product range with both loop-powered and universal isolators featuring linearization, inversion, and scaling of output signals.























Temperature A wide selection of transmitters for DIN form B mounting and DIN rail devices with analog and digital bus communication ranging from application-specific to universal transmitters.



Universal PC or front programmable devices with universal options for input, output and supply. This range offers a number of advanced features such as process calibration, linearization and auto-diagnosis.



-   www.preelectronics.fr
 sales-fr@preelectronics.com
-   www.preelectronics.de
 sales-de@preelectronics.com
-   www.preelectronics.es
 sales-es@preelectronics.com
-   www.preelectronics.it
 sales-it@preelectronics.com
-   www.preelectronics.se
 sales-se@preelectronics.com
-   www.preelectronics.com
 sales-uk@preelectronics.com
-   www.preelectronics.com
 sales-us@preelectronics.com
-   www.preelectronics.cn
 sales-cn@preelectronics.com

Head office

Denmark
PR electronics A/S
Lerbakken 10
DK-8410 Rønne

www.preelectronics.com
sales@preelectronics.dk
tel. +45 86 37 26 77
fax +45 86 37 30 85