



Isolation Galvanic isolators for analogue and digital signals as well as HART® signals. A wide product range with both loop-powered and universal isolators featuring linearisation, inversion, and scaling of output signals.



Displays Programmable displays with a wide selection of inputs and outputs for display of temperature, volume, weight, etc. Feature linearisation, scaling, and difference measurement functions for programming via PReset software.



Ex barriers Interfaces for analogue and digital signals as well as HART® signals between sensors / I/P converters / frequency signals and control systems in Ex zone 0, 1 & 2. Feature options such as mathematical functions and 2 wire transmitter interfaces.



Temperature A wide selection of transmitters for DIN form B mounting and DIN rail modules with analogue and digital bus communication ranging from application-specific to universal transmitters.



Backplane Flexible motherboard solutions for system 5000 modules. Our backplane range features flexible 8 and 16 module solutions with configuration via PReplan 8470 – a PC program with drop-down menus.



DK Side 1

UK Page 15

FR Page 29

DE Seite 43



5 3 3 5

**2-Wire Transmitter
with HART® Protocol**

No. 5335V107-IN (0324)
From ser. no. 030901001



SIGNALS THE BEST

2-TRÅDS TRANSMITTER MED HART[®] PROTOKOL

PRetop 5335

Indholdsfortegnelse

Sikkerhedsinstruktion	2
Overensstemmelseserklæring	3
Anvendelse	4
Teknisk karakteristik	4
Montage / installation.....	4
Applikationer	5
Bestillingsskema.....	6
Elektriske specifikationer	6
Tilslutninger	10
Blokdiagram	11
Programmering.....	12
Forbindelse af transmittere i multidrop	14
Mekaniske specifikationer	14
Appendix:	
FM Control Drawing No. 5300Q502	58
CSA Installation Drawing No. 533XQC03	62

Sikkerhedsinstruktion

- **Ex-installation:**

For sikker installation af 5335B i eksplosionsfarligt område skal følgende overholdes. Installation må kun foretages af kvalificeret personale, der er bekendt med de nationale og internationale love, direktiver og standarder, der gælder for området.

OVERENSSTEMMELSESERKLÆRING

Som producent erklærer

PR electronics A/S
Lerbakken 10
DK-8410 Rønde

hermed at følgende produkt:

Type: 5335
Navn: 2-Tråds transmitter med HART® protokol

er i overensstemmelse med følgende direktiver og standarder:

EMC-direktivet 89/336/EEC og senere tilføjelser

Fra serienr.: 990904001 ff
EN 61 326
EN 50 081-1 og EN 50 081-2
EN 50 082-1 og EN 50 082-2

Denne erklæring er udgivet i overensstemmelse med EMC-direktivets paragraf 10, stk. 1. For specifikation af det acceptable EMC-niveau henvises til modulets elektriske specifikationer.

ATEX-direktivet 94/9/EC og senere tilføjelser

Fra serienr.: 990904001 ff
EN 50 014 og EN 50 020
Ex-certifikat: 99 ATEX 126965

Bemyndiget organ for CENELEC / ATEX: **UL International Demko A/S 0539**

Rønde, 4. jan. 2000



Peter Rasmussen
Producentens underskrift

2-TRÅDS TRANSMITTER MED HART[®] PROTOKOL

Pretop 5335

- Indgang for RTD, TC, Ohm eller mV
- Ekstrem målenøjagtighed
- HART[®]-kommunikation
- Galvanisk isolation
- Kan monteres i DIN form B følerhoved

Anvendelse:

- Temperaturlineariseret måling med Pt100...Pt1000, Ni100...Ni1000 eller termoelementføler.
- Differens- eller gennemsnitstemperaturmåling på 2 modstands- eller TC-følere.
- Omsætning af lineær modstandsændring til standard analogt strømsignal, f.eks. fra ventiler eller ohmske niveaustave.
- Forstærkning af bipolært mV-signal til et standard 4...20 mA strømsignal.
- Kobling af op til 15 transmittere til et digitalt 2-leder signal med HART[®]-kommunikation.

Teknisk karakteristik:

- PR5335 kan af brugeren i løbet af få sekunder programmeres til at måle inden for alle normerede temperaturområder.
- RTD- og modstandsindgangen har kabelkompensering for 2-, 3- og 4-leder tilslutning.
- Der er løbende sikkerhedscheck af gemte data.
- Følerfejlsdetektering iht. retningslinierne i NAMUR NE 89.

Montage / installation:

- Kan monteres i DIN form B følerhoved eller på DIN-skinne med et specielt beslag.
- **NB:** Som Ex-barriere for 5335B anbefaler vi 5106B.

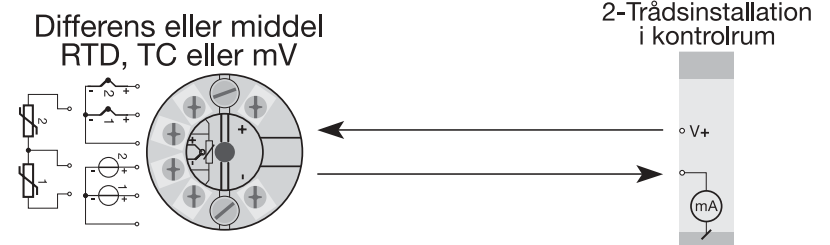
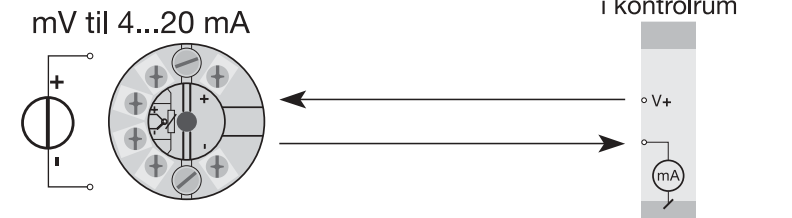
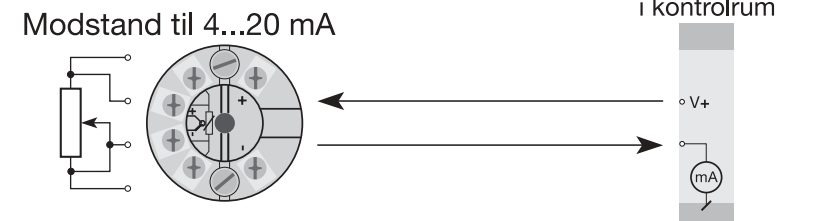
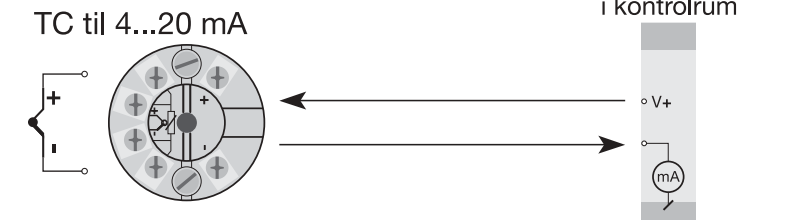
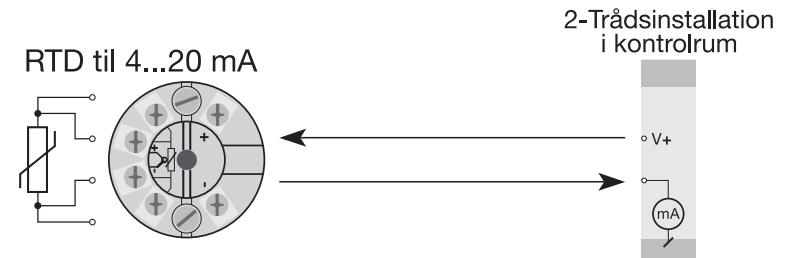

Bestillingsskema: 5335

Type	Version
5335	Standard : A
	ATEX : B
	FM og ATEX : C
	CSA, FM og ATEX : D

Elektriske specifikationer:

Specifikationsområde:

(@: -40°C til +85°C)

Fælles specifikationer:

Forsyningsspænding DC

Standard	8,0...35 V
ATEX, FM og CSA, 5335B, C og D.....	8,0...28 V
Isolationsspænding, test / drift	1,5 kVAC / 50 VAC
Opvarmningstid.....	30 s
Kommunikationsinterface.....	HART® og Loop Link 5905A
Signal- / støjforhold.....	min. 60 dB
Reaktionstid (programmerbar)	1...60 s
EEPROM fejlcheck	< 10 s
Signaldynamik, indgang.....	22 bit
Signaldynamik, udgang.....	16 bit
Kalibreringstemperatur	20...28°C
Nøjagtighed, størst af generelle og basisværdier:	

Generelle værdier		
Indgangstype	Absolut nøjagtighed	Temperaturkoefficient
Alle	$\leq \pm 0,05\%$ af span	$\leq \pm 0,005\%$ af span / °C

Basisværdier		
Indgangstype	Basis nøjagtighed	Temperaturkoefficient
Pt100 og Pt1000	$\leq \pm 0,1^\circ\text{C}$	$\leq \pm 0,005^\circ\text{C}/^\circ\text{C}$
Ni100	$\leq \pm 0,2^\circ\text{C}$	$\leq \pm 0,005^\circ\text{C}/^\circ\text{C}$
Lin.R	$\leq \pm 0,1 \Omega$	$\leq \pm 5 \text{ m}\Omega/^\circ\text{C}$
Volt	$\leq \pm 10 \mu\text{V}$	$\leq \pm 0,5 \mu\text{V}/^\circ\text{C}$
TC-type: E, J, K, L, N, T, U	$\leq \pm 0,5^\circ\text{C}$	$\leq \pm 0,025^\circ\text{C}/^\circ\text{C}$
TC-type: B, R, S, W3, W5	$\leq \pm 1^\circ\text{C}$	$\leq \pm 0,1^\circ\text{C}/^\circ\text{C}$

EMC-immunitetspårvirkning.....	< $\pm 0,1\%$ af span
Udvidet EMC-immunitet:	
NAMUR NE 21, A kriterium, gniststøj	< $\pm 1\%$ af span

Virkning af forsyningsspændings-

ændring	< 0,005% af span / VDC
Vibration	IEC 68-2-6 Test FC
Lloyd's specifikation nr. 1.....	4 g / 2...100 Hz
Max. ledningskvadrat	1 x 1,5 mm ²
Luffugtighed	< 95% RH (ikke kond.)
Mål.....	Ø 44 x 20,2 mm
Tæthedegrad (hus / klemme)	IP68 / IP00
Vægt	50 g

Elektriske specifikationer indgang:

Max. nulpunktsforskydning (offset)..... 50% af valgt numerisk max. værdi

RTD- og lineær modstandsindgang:

RTD-type	Min. værdi	Max. værdi	Min. span
Pt100	-200°C	+850°C	10°C
Ni100	-60°C	+250°C	10°C
Lin.R	0 Ω	7000 Ω	25 Ω

Kabelmodstand pr. leder (max.) 5 Ω
 Følerstrøm Nom. 0,2 mA
 Virkning af følerkabelmodstand
 (3- / 4-leder) < 0,002 Ω/Ω
 Følerfejlsdetektering Ja
 Kortslutningsdetektering Hvis 0% > 30 Ω

TC-indgang:

Type	Min. temperatur	Max. temperatur	Min. span	Norm
B	+400°C	+1820°C	100°C	IEC584
E	-100°C	+1000°C	50°C	IEC584
J	-100°C	+1200°C	50°C	IEC584
K	-180°C	+1372°C	50°C	IEC584
L	-100°C	+900°C	50°C	DIN 43710
N	-180°C	+1300°C	50°C	IEC584
R	-50°C	+1760°C	100°C	IEC584
S	-50°C	+1760°C	100°C	IEC584
T	-200°C	+400°C	50°C	IEC584
U	-200°C	+600°C	50°C	DIN 43710
W3	0°C	+2300°C	100°C	ASTM E988-90
W5	0°C	+2300°C	100°C	ASTM E988-90

Koldt loddestedskomp. (CJC) < ±1,0 °C
 Ekstern CJC med Ni100 eller Pt100 -40 ≤ T_{omg.} ≤ 135°C
 Følerfejlsdetektering Ja
 Følerfejlsstrøm:
 under detektering Nom. 33 µA
 ellers 0 µA
 Kortslutningsdetektering Hvis 0% > 5 mV

Spændingsindgang:

Måleområde -800...+800 mV
 Min. måleområde (span) 2,5 mV
 Indgangsmodstand 10 MΩ

Strømodgang:

Signalområde 4...20 mA
 Min. signalområde 16 mA
 Opdateringstid 440 ms
 (660 ms for diff.)
 Fast udgangssignal Mellem 4 og 20 mA
 Udgangssignal ved EEpromfejl ≤ 3,5 mA
 Belastningsmodstand ≤ (V_{forsyn.} - 8) / 0,023 [Ω]
 Belastningsstabilitet < ±0,01% af span / 100 Ω

Følerfejlsdetektering:

Programmerbar 3,5...23 mA
 NAMUR NE43 Upscale 23 mA
 NAMUR NE43 Downscale 3,5 mA

Ex-data:

Signaludgang / forsyning, terminal 1 til 2:
 U_i : 30 VDC
 I_i : 120 mADC
 P_i : 0,84 W
 L_i : 10 µH
 C_i : 1,0 nF
 Følerindgang, terminal 3, 4, 5 og 6:
 U_o : 9,6 VDC
 I_o : 28 mA
 P_o : 67 mW
 L_o : 35 mH
 C_o : 3,5 µF

EEx-godkendelse CENELEC:

DEMKO 99 ATEX 126965
ATEX 0539  II 1 G
 EEx ia IIC T1...T6
 Max. omgivelsestemp. for T1...T4 85°C
 Max. omgivelsestemp. for T5 og T6 60°C
 Anvendes i zone 0, 1 eller 2
FM IS, CL. I, DIV. 1, GP. A-D
 Entity, FM Control Drawing No. 5300Q502
CSA Class I, Zone 0/1, Group IIC
 Installation Drawing No. 533XQC03
Overholdte myndighedskrav: **Standard:**
 EMC 89/336/EØF, Emission EN 50 081-1, EN 50 081-2
 Immunitet EN 50 082-2, EN 50 082-1
 Emission og immunitet EN 61 326
 ATEX 94/9/EF EN 50 014 og EN 50 020
 Factual Mutual, ASCN 3600, 3810, 3611, 3610
 CSA, CAN / CSA E79-15, E79-11

Af span = Af det aktuelt valgte område

Tilslutninger:

Indgang:

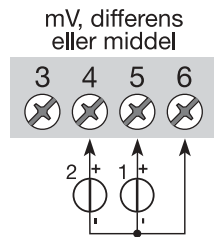
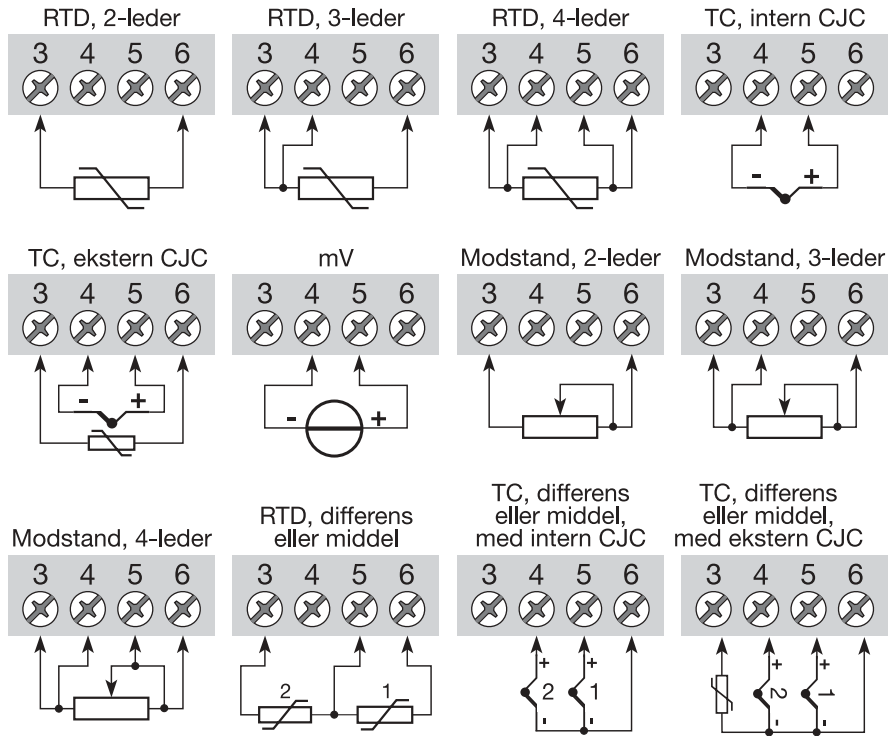

Udgang:

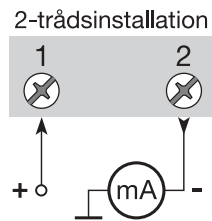

BLOKDIAGRAM:

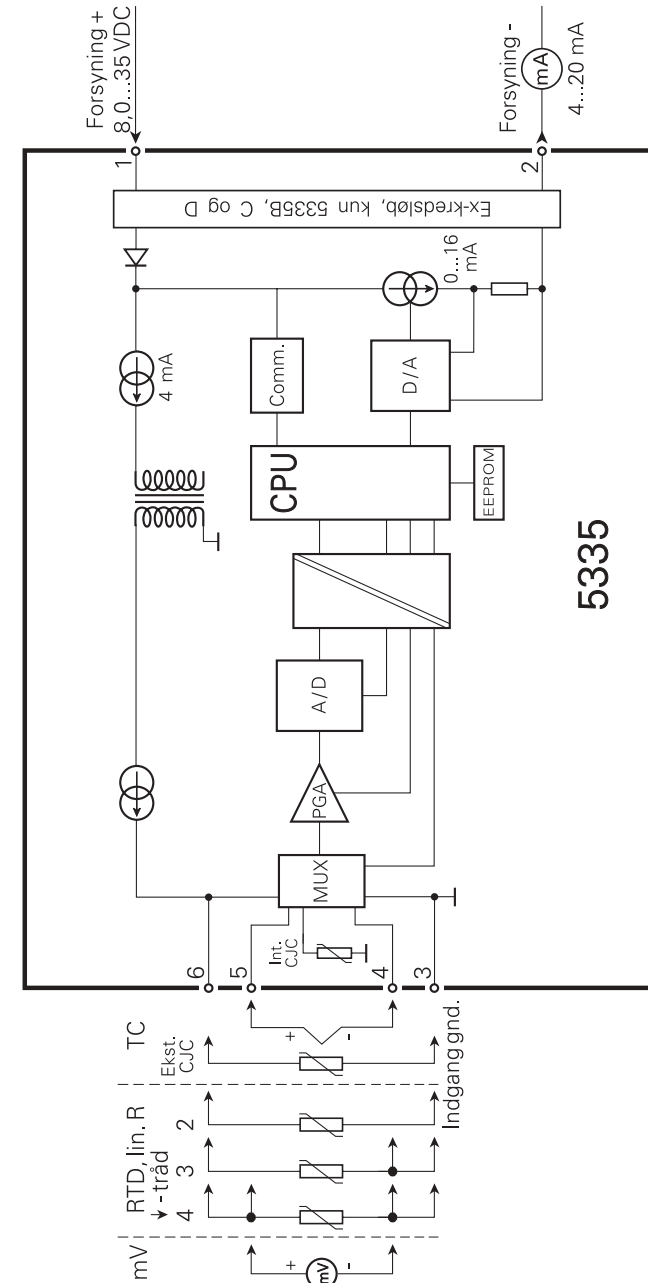

Programmering:

PRetop 5335 kan konfigureres på 3 måder:

- 1 Med PR electronics A/S' kommunikationsinterface Loop Link 5905A og PReset PC konfigurationssoftware.
2. Med HART® modem og PReset PC konfigurationssoftware.
3. Med HART® kommunikator indeholdende PR electronics A/S' DDL driver.

1: Loop Link 5905A:

Ved programmering henvises til tegningen nedenfor og hjælpefunktionen i PReset programmet.

Loop Link 5905A må ikke benyttes til kommunikation med moduler installeret i Ex-område.

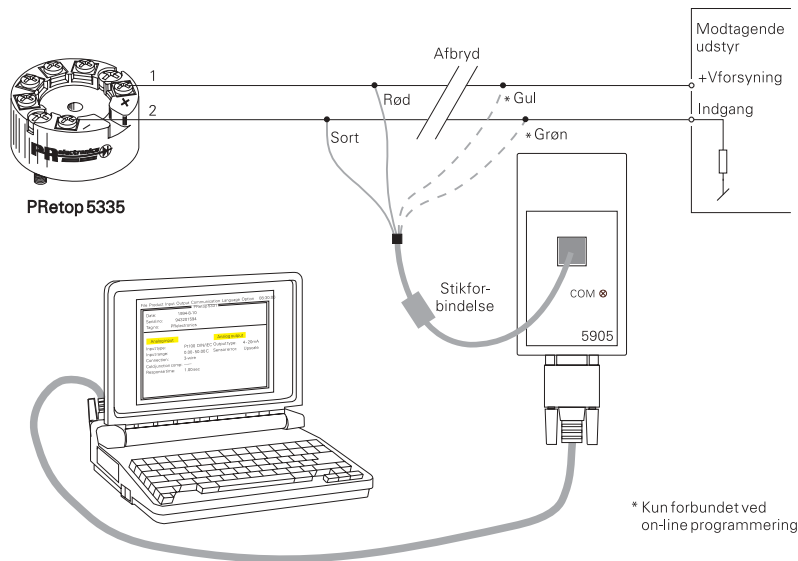

2: HART® modem:

Ved programmering henvises til tegningen nedenfor og hjælpefunktionen i PReset programmet.

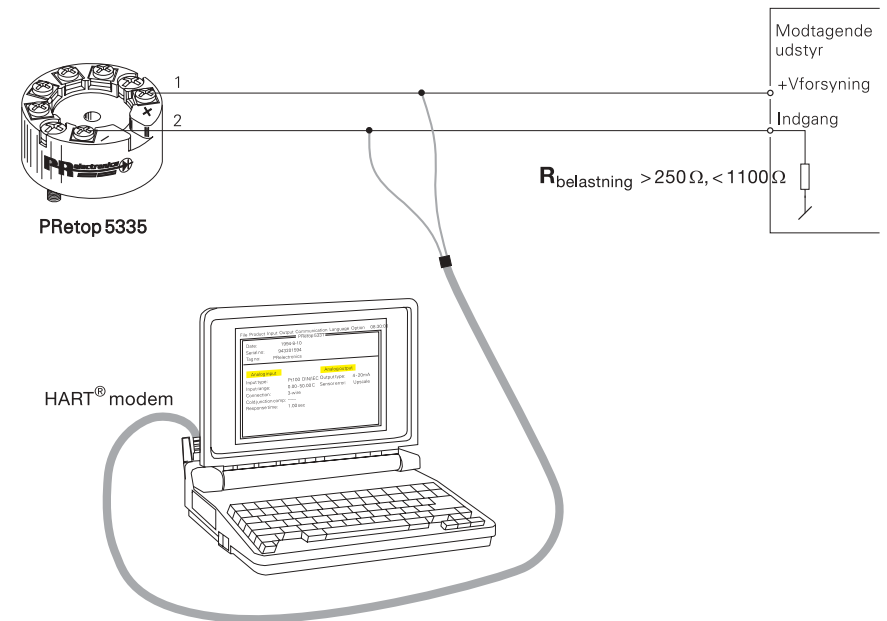

3: HART® kommunikator:

Ved programmering henvises til tegningen nedenfor. For at få adgang til produktspecifikke kommandoer skal HART® kommunikatoren indeholde PR electronics A/S' DDL driver. Denne kan rekvireres enten hos HART® Communication Foundation eller hos PR electronics A/S.

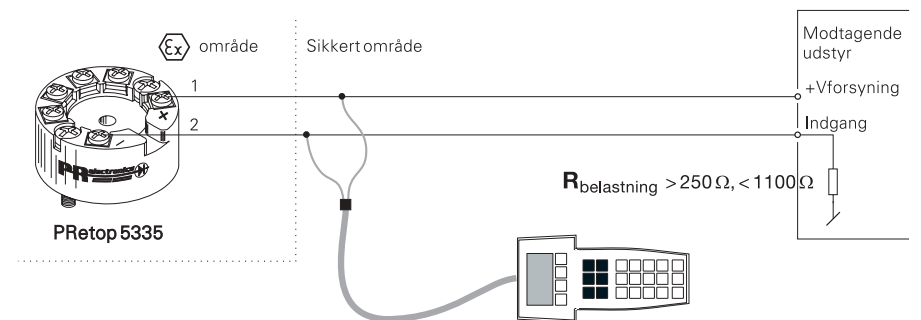

Forbindelse af transmittere i multidrop:

HART[®] kommunikatoren eller PC-modem kan tilsluttes over punkterne AB eller BC.

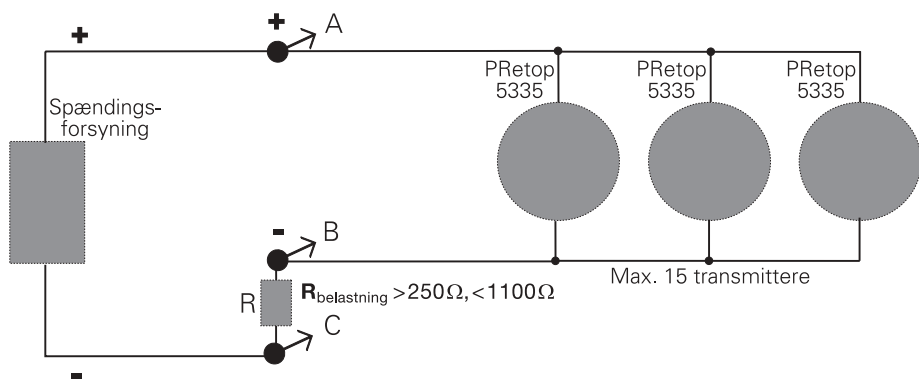

Udgangene på op til 15 transmittere kan parallelforbindes for digital HART[®]-kommunikation på 2-ledere.

Hver transmitter skal, inden den tilsluttes, konfigureres med et unikt nummer fra 1 - 15. Hvis 2 transmittere konfigureres med samme nummer, ses der bort fra begge. Transmitterne skal programmeres til multidrop mode (med et fast udgangssignal på 4 mA). Den maksimale strøm i sløjfen kan dermed blive 60 mA.

Kommunikationen kan foregå via HART[®] kommunikator eller HART[®] modem.

PRreset PC konfigurationssoftwaren kan konfigurere den enkelte transmitter til multidrop mode og tildele en unik polling adresse.

Mekaniske specifikationer:

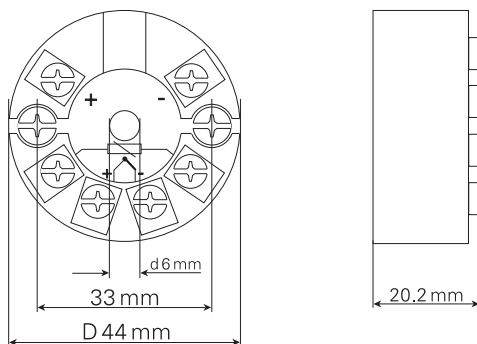

2-WIRE TRANSMITTER WITH HART[®] PROTOCOL

PRetop 5335

CONTENTS

Safety instructions.....	16
Declaration of Conformity	17
Application	18
Technical characteristics	18
Mounting / installation.....	18
Applications.....	19
Order	20
Electrical specifications.....	20
Connections	24
Block diagram	25
Programming	26
Connection of transmitters in multidrop mode	28
Mechanical specifications	28
Appendix:	
FM Control Drawing No. 5300Q502	58
CSA Installation Drawing No. 533XQC03	62

Safety instructions

- **Ex installation:**

For a safe installation of 5335B in hazardous area the following must be observed. The module must only be installed by qualified personnel who are familiar with the national and international laws, directives and standards that apply to this area.

DECLARATION OF CONFORMITY

As manufacturer

**PR electronics A/S
Lerbakken 10
DK-8410 Rønede**

hererby declares that the following product:

Type: 5335

Name: 2-Wire transmitter with HART® protocol

is in conformity with the following directives and standards:

EMC directive 89/336/EEC and later amendments

From serial no.: 990904001 ff

EN 61 326

EN 50 081-1, EN 50 081-2

EN 50 082-1, EN 50 082-2

This declaration is issued in compliance with article 10, subclause 1 of the EMC directive. For specification of the acceptable EMC performance level, refer to the electrical specifications for the module.

The ATEX directive 94/9/EC and later amendments

From serial no.: 990904001 ff

EN 50 014 and EN 50 020

Ex certificate: 99 ATEX 126965

Notified body for CENELEC/ATEX: UL International Demko A/S 0539

Rønede, 4 Jan. 2000



Peter Rasmussen
Manufacturer's signature

2-WIRE TRANSMITTER WITH HART® PROTOCOL PReTop 5335

- *RTD, TC, Ohm, or mV input*
- *Extremely high measurement accuracy*
- *HART® communication*
- *Galvanic isolation*
- *For DIN form B sensor head mounting*

Application:

- Linearised temperature measurement with Pt100...Pt1000, Ni100...Ni1000, or TC sensor.
- Difference or average temperature measurement of 2 resistance or TC sensors.
- Conversion of linear resistance variation to a standard analogue current signal, for instance from valves or Ohmic level sensors.
- Amplification of a bipolar mV signal to a standard 4...20 mA current signal.
- Connection of up to 15 transmitters to a digital 2-wire signal with HART® communication.

Technical characteristics:

- Within a few seconds the user can program PR5335 to measure temperatures within all ranges defined by the norms.
- The RTD and resistance inputs have cable compensation for 2-, 3- and 4-wire connection.
- Continuous check of vital stored data for safety reasons.
- Sensor error detection according to the guidelines in NAMUR NE 89.

Mounting / installation:

- For DIN form B sensor head or DIN rail mounting with a special fitting.
- **NB:** As Ex barrier for 5335B we recommend 5106B.

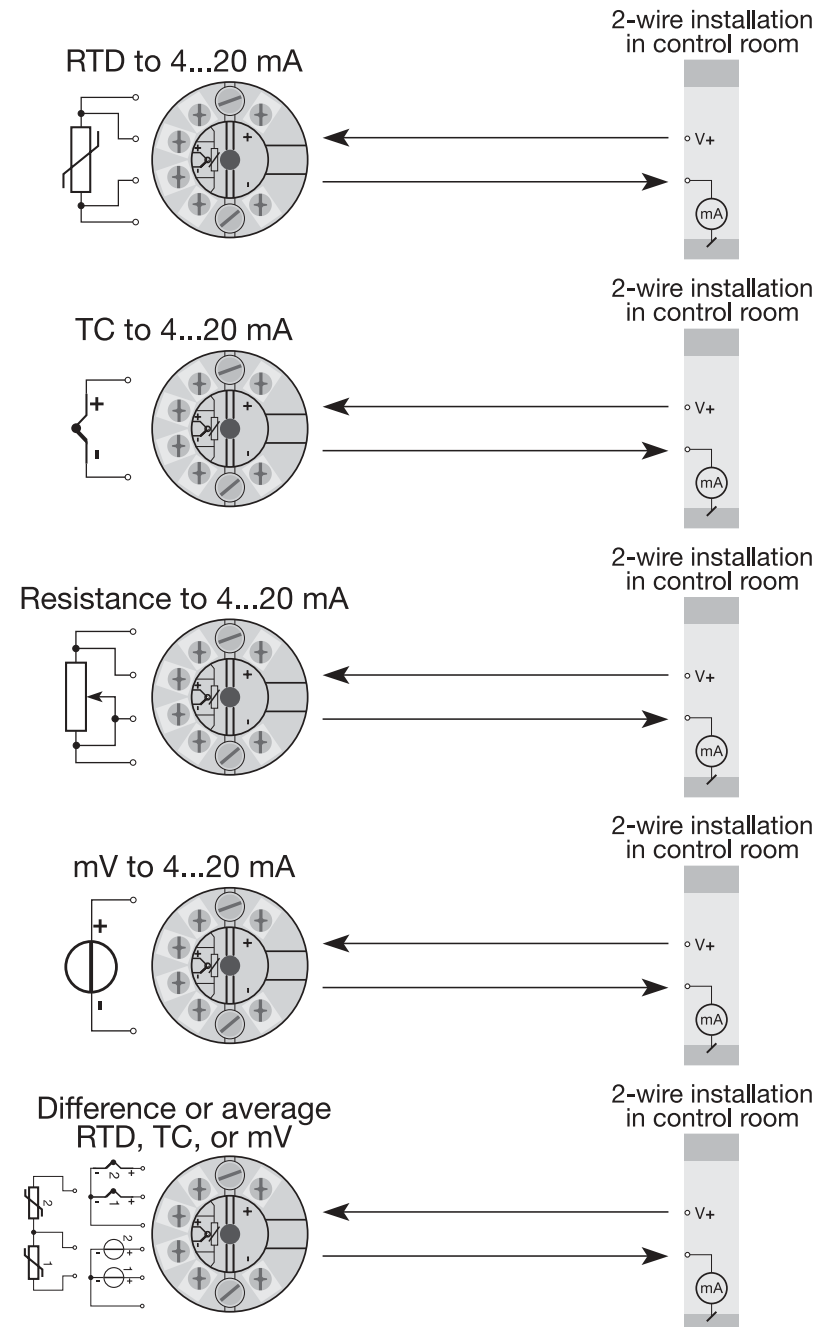

Order: 5335

Type	Version
5335	Standard : A
	ATEX : B
	FM and ATEX : C
	CSA, FM and ATEX : D

Electrical specifications:

Specifications range:

(@: -40°C to +85°C)

Common specifications:

Supply voltage, DC

Standard	8.0...35 V
ATEX, FM and CSA, 5335B, C and D..	8.0...28 V
Isolation voltage, test / operation	1.5 kVAC / 50 VAC
Warm-up time.....	30 s
Communications interface	HART® and Loop Link 5905A
Signal / noise ratio	Min. 60 dB
Response time (programmable).....	1...60 s
EEPROM error check	< 10 s
Signal dynamics, input.....	22 bit
Signal dynamics, output	16 bit
Calibration temperature	20...28°C

Accuracy, the greater of general and basic values:

General values		
Input type	Absolute accuracy	Temperature coefficient
All	≤ ±0.05% of span	≤ ±0.005% of span / °C

Basic values		
Input type	Basic accuracy	Temperature coefficient
Pt100 and Pt1000	≤ ±0.1°C	≤ ±0.005°C/°C
Ni100	≤ ±0.2°C	≤ ±0.005°C/°C
Lin. R	≤ ±0.1 Ω	≤ ±5 mΩ/°C
Volt	≤ ±10 μV	≤ ±0.5 μV/°C
TC type: E, J, K, L, N, T, U	≤ ±0.5°C	≤ ±0.025°C/°C
TC type: B, R, S, W3, W5	≤ ±1°C	≤ ±0.1°C/°C

EMC immunity influence	< ±0.1% of span
Extended EMC immunity: NAMUR NE 21, A criterion, burst	< ±1% of span

Effect of supply voltage variation.....	< 0.005% of span / VDC
Vibration	IEC 68-2-6 Test FC
Lloyd's specification no. 1	4 g / 2...100 Hz
Max. wire size.....	1 x 1.5 mm ²
Relative humidity.....	< 95% RH (non-cond.)
Dimensions.....	Ø 44 x 20.2 mm
Tightness (enclosure / terminals)	IP68 / IP00
Weight	50 g

Electrical specifications, input:

Max. offset

RTD and linear resistance input:

RTD type	Min. value	Max. value	Min. span
Pt100	-200°C	+850°C	10°C
Ni100	-60°C	+250°C	10°C
Lin. R	0 Ω	7000 Ω	25 Ω

Cable resistance per wire (max.)..... 5 Ω
 Sensor current..... Nom. 0.2 mA
 Effect of sensor cable resistance
 (3- / 4-wire)..... < 0.002 Ω/Ω
 Sensor error detection Yes
 Short circuit detection..... If 0% > 30 Ω

TC input:

Type	Min. temperature	Max. temperature	Min. span	Norm
B	+400°C	+1820°C	100°C	IEC584
E	-100°C	+1000°C	50°C	IEC584
J	-100°C	+1200°C	50°C	IEC584
K	-180°C	+1372°C	50°C	IEC584
L	-100°C	+900°C	50°C	DIN 43710
N	-180°C	+1300°C	50°C	IEC584
R	-50°C	+1760°C	100°C	IEC584
S	-50°C	+1760°C	100°C	IEC584
T	-200°C	+400°C	50°C	IEC584
U	-200°C	+600°C	50°C	DIN 43710
W3	0°C	+2300°C	100°C	ASTM E988-90
W5	0°C	+2300°C	100°C	ASTM E988-90

Cold junction compensation < ±1.0°C
 External CJC with Ni100 or Pt100 -40 ≤ T_{amb.} ≤ 135°C
 Sensor error detection Yes
 Sensor error current:
 When detecting..... Nom. 33 µA
 Else 0 µA
 Short circuit detection..... If 0% > 5 mV

Voltage input:

Measurement range -800...+800 mV
 Min. span..... 2.5 mV
 Input resistance..... 10 MΩ

Current output:

Signal range 4...20 mA
 Min. signal range..... 16 mA
 Updating time..... 440 ms
 (660 ms for diff.)
 Fixed output signal..... Between 4 and 20 mA
 Output signal at EEPROM error ≤ 3.5 mA
 Load resistance..... ≤ (V_{supply} - 8) / 0.023 [Ω]
 Load stability..... < ±0.01% of span / 100 Ω

Sensor error detection:

Programmable..... 3.5...23 mA
 NAMUR NE43 Upscale 23 mA
 NAMUR NE43 Downscale..... 3.5 mA

Ex data:

Signal output / supply, terminal 1 to 2:

U_i..... : 30 VDC
 I_i..... : 120 mADC
 P_i..... : 0.84 W
 L_i..... : 10 µH
 C_i..... : 1.0 nF

Sensor input, terminal 3, 4, 5 and 6:

U_o..... : 9.6 VDC
 I_o..... : 28 mA
 P_o..... : 67 mW
 L_o..... : 35 mH
 C_o..... : 3.5 µF

EEx approval CENELEC:

DEMKO 99 ATEX 126965
ATEX 0539  II 1 G
 EEx ia IIC T1...T6

Max. amb. temperature for T1...T4 85°C
 Max. amb. temperature for T5 and T6 60°C
 Applicable in zone 0, 1 or 2
FM IS, CL. I, DIV. 1, GP. A-D
 Entity, FM Control Drawing No. 5300Q502

CSA Class I, Zone 0/1, Group IIC
 Installation Drawing No. 533XQC03

Observed authority requirements:

Standard:
 EMC 89/336/EEC, Emission EN 50 081-1, EN 50 081-2
 Immunity EN 50 082-2, EN 50 082-1
 Emission and immunity EN 61 326
 ATEX 94/9/EC..... EN 50 014 and EN 50 020
 Factory Mutual, ASCN 3600, 3810, 3611, 3610
 CSA, CAN / CSA E79-15, E79-11

Of span = Of the presently selected range

Connections:

Input:

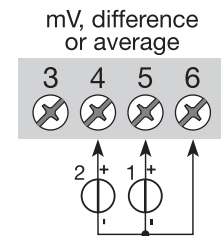
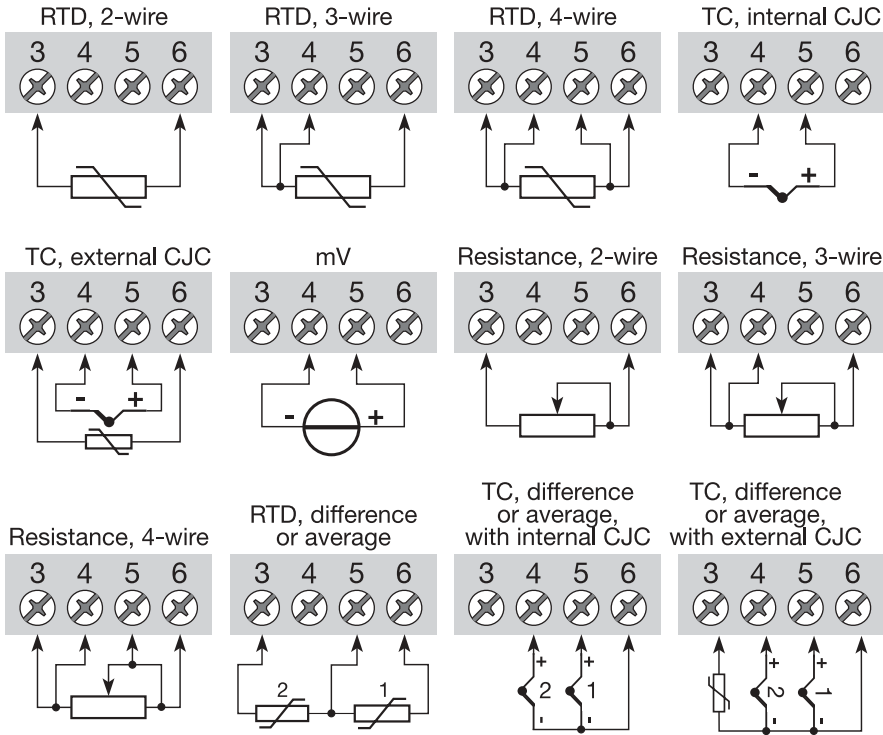

Output:

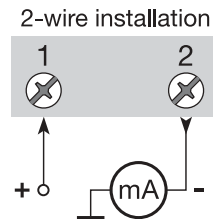

BLOCK DIAGRAM:

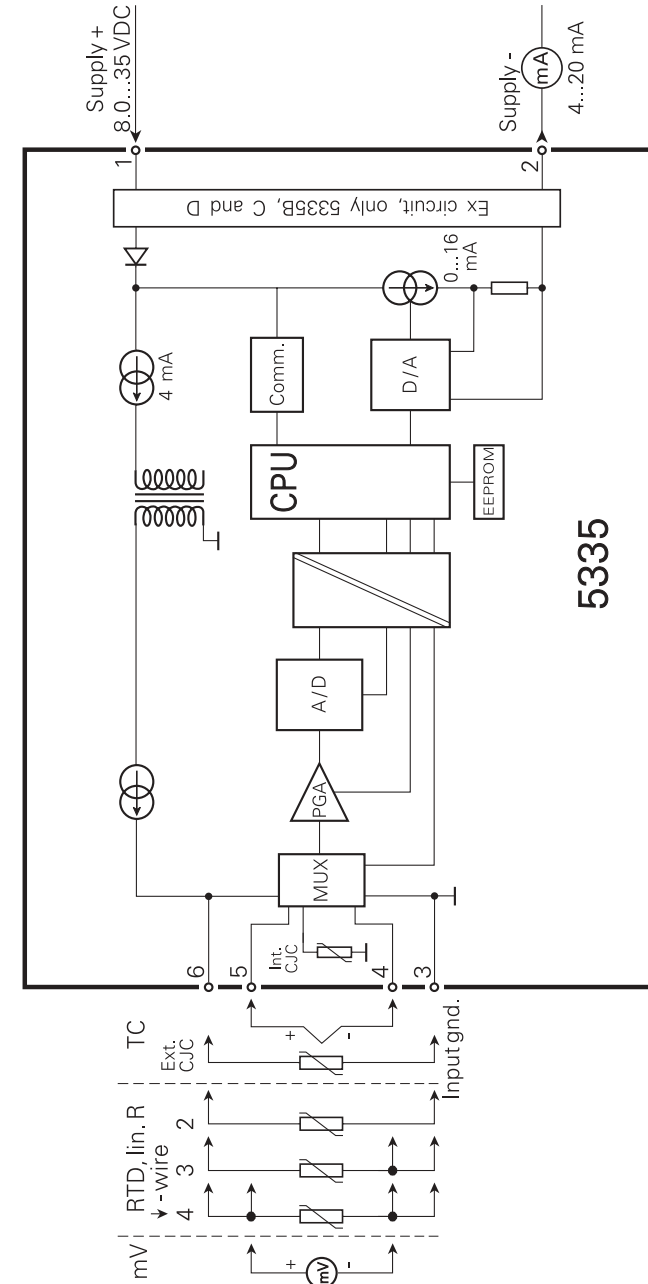

Programming:

PRetop 5335 can be configured in the following 3 ways:

- 1 With PR electronics A/S' communications interface Loop Link 5905A and PReset PC configuration software.
2. With a HART® modem and PReset PC configuration software.
3. With a HART® communicator with PR electronics A/S' DDL driver.

1: Loop Link 5905A:

For programming please refer to the drawing below and the help functions in PReset.

Loop Link 5905A is not approved for communication with modules installed in hazardous (Ex) areas.

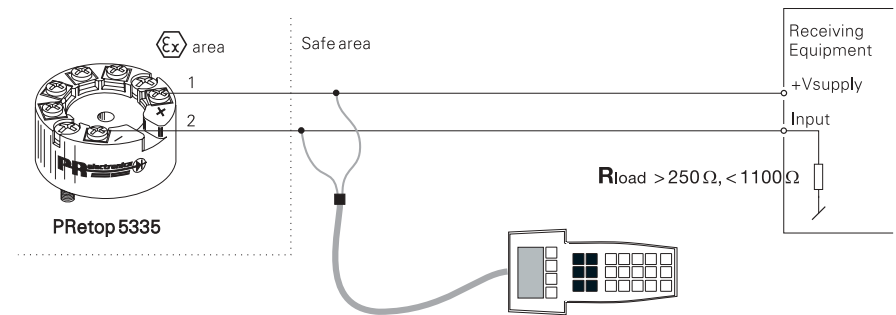
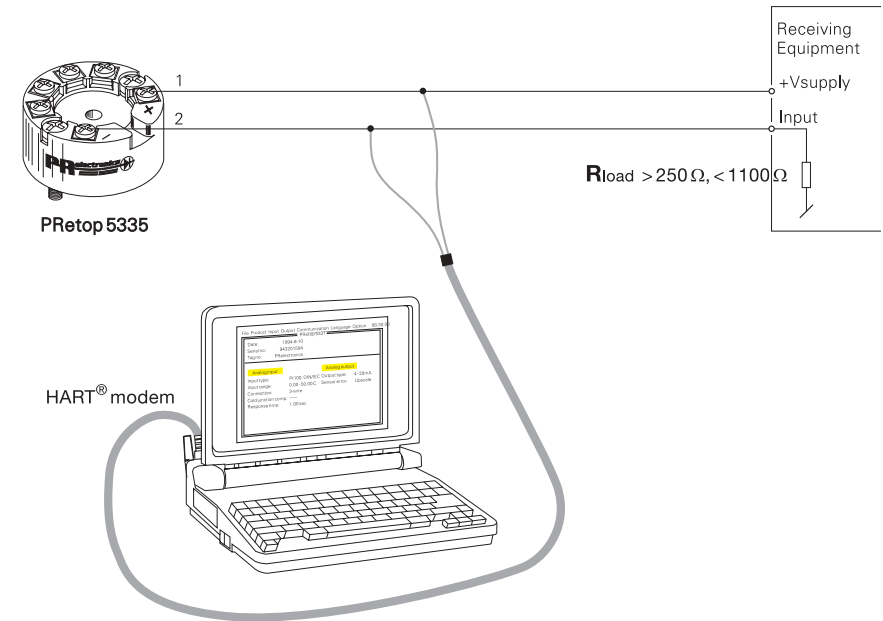
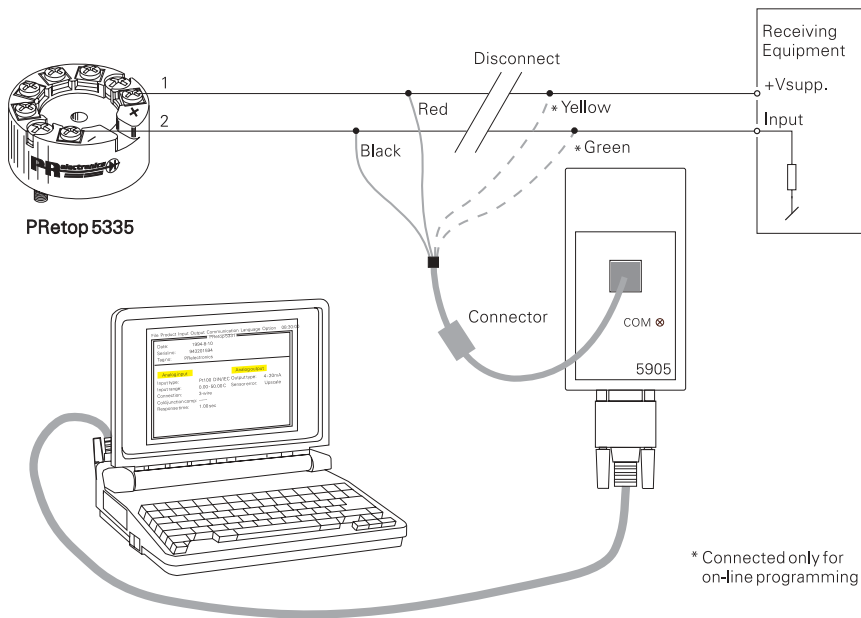

TRANSMETTEUR 2-FILS AVEC PROTOCOLE HART®

PRetop 5335

SOMMAIRE

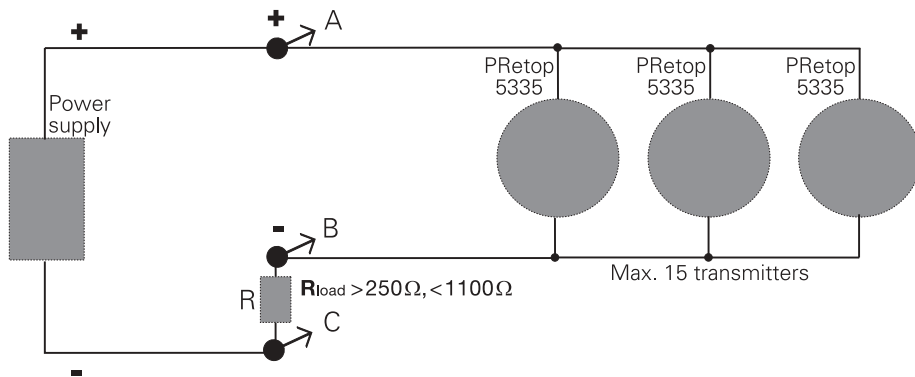

Consignes de sécurité	30
Declaration de conformité.....	31
Application	32
Caractéristiques techniques	32
Montage / installation.....	32
Applications.....	33
Référence	34
Spécifications électriques	34
Connexions	38
Schéma de principe	39
Programmation.....	40
Raccordement des transmetteurs en multi-adressage.....	42
Dimensions mécaniques	42
Appendix:	
FM Control Drawing No. 5300Q502	58
CSA Installation Drawing No. 533XQC03	62

2: HART® modem:

For programming please refer to the drawing below and the help functions in PReset.

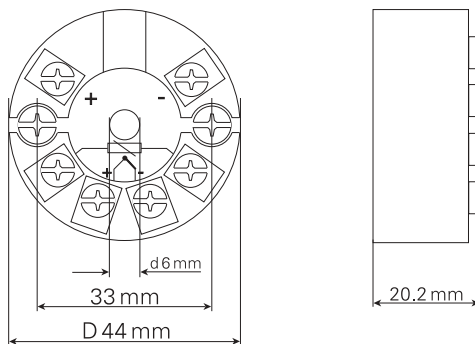

3: HART® communicator:

Consignes de sécurité

- **Installation S.I. :**

Pour l'installation de 5335B dans les zones dangereuses, conformez-vous aux consignes de sécurité suivantes : l'installation ne doit être réalisée que par du personnel qualifié connaissant la législation nationale et internationale ainsi que les directives et standards régissant ce domaine.

DECLARATION DE CONFORMITE

En tant que fabricant

PR electronics A/S
Lerbakken 10
DK-8410 Rønne

déclare que le produit suivant :

Type : 5335
Nom : Transmetteur 2-fils avec protocole HART®

correspond aux directives et normes suivantes :

La directive CEM (EMC) 89/336/EEC et les modifications subséquentes

A partir du no. de série : 990904001 sqq.
EN 61 326
EN 50 081-1, EN 50 081-2
EN 50 082-1, EN 50 082-2

Cette déclaration est délivrée en correspondance à l'article 10, alinéa 1 de la directive CEM. Pour une spécification du niveau de rendement acceptable CEM (EMC) se référer aux spécifications électriques du module.

La directive ATEX 94/9/EC et les modifications subséquentes

A partir du no. de série : 990904001 sqq.
EN 50 014 et EN 50 020
Certificat Ex : 99 ATEX 126965

Organisme notifié pour CENELEC/ATEX: **UL International Demko A/S 0539**



Rønne, le 4 janvier 2000

Peter Rasmussen
Signature du fabricant

TRANSMETTEUR 2-FILS AVEC PROTOCOLE HART®

PRetop 5335

- Entrée RTD, TC, Ohm ou mV
- Très grande précision de mesure
- Communication avec protocole HART®
- Isolation galvanique
- Pour tête de sonde DIN B

Application :

- Mesure linéarisée de la température avec un capteur Pt100...Pt1000, Ni100...Ni1000 ou de thermocouples.
- Mesure de la température différentielle ou moyenne avec 2 sondes résistives ou thermocouples.
- Conversion d'une résistance linéaire en un signal courant standard analogique pour mesurer par exemple le niveau ou la position d'une vanne.
- Amplification d'un signal mV bipolaire en un signal courant standard de 4...20 mA.
- Connexion en parallèle de 15 transmetteurs au maximum pour une communication digitale avec le protocole HART®.

Caractéristiques techniques :

- Le PR5335 peut être programmé de manière simple et rapide.
- Compensation de ligne pour des entrées RTD et résistance avec un raccordement à 2, 3 et 4 fils.
- Vérification continue des données sauvegardés.
- Détection de rupture sonde selon les recommandations NAMUR NE 89.

Montage / installation :

- Pour tête de sonde DIN B ou pour rail DIN avec un raccord spécial.
- **N.B.** : Comme barrière S.I. pour le 5335B nous recommandons le PR5106B.

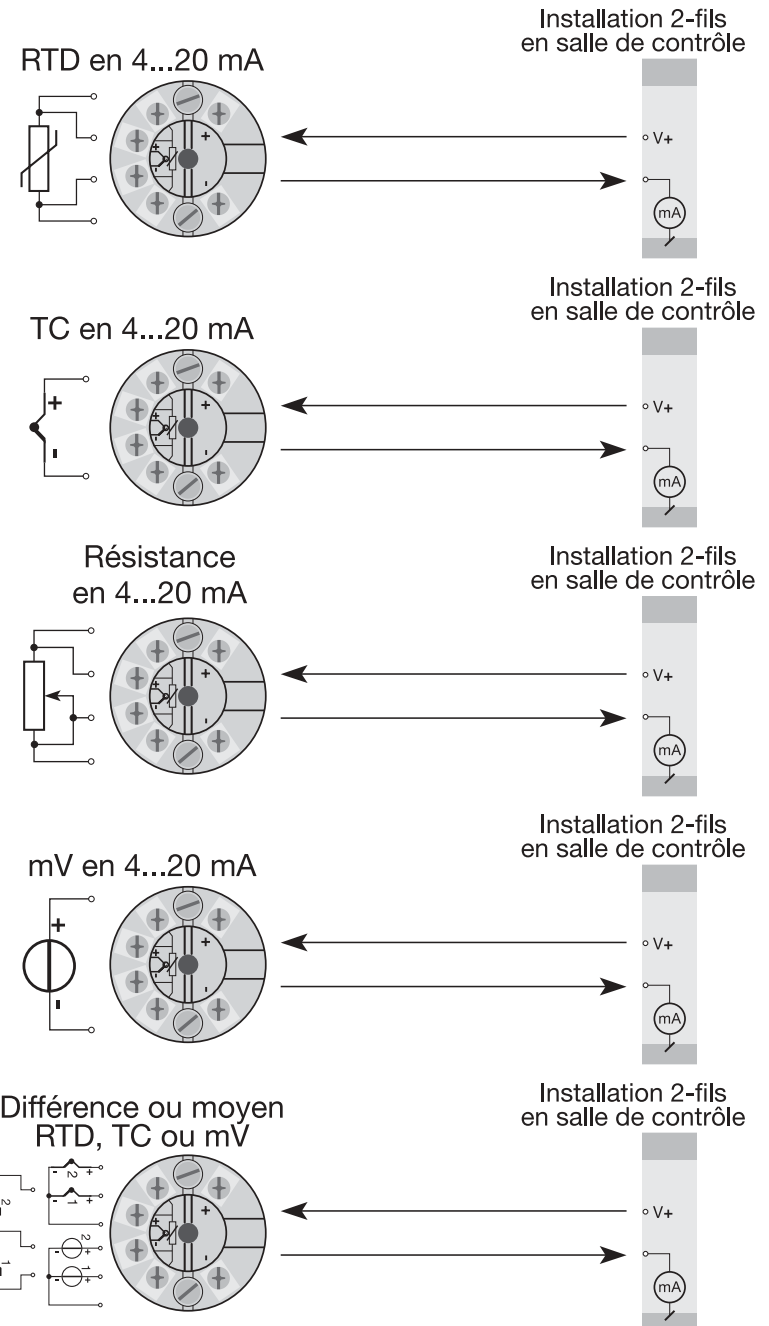

Référence : 5335

Type	Version
5335	Standard : A
	ATEX : B
	FM et ATEX : C
	CSA, FM et ATEX : D

Spécifications électriques :

Plage des spécifications :

(@ : -40°C à +85°C)

Spécifications communes :

Tension d'alimentation cc

Standard 8,0...35 V

ATEX, FM et CSA, 5335B, C et D 8,0...28 V

Tension d'isolation, test / opération 1,5 kVca / 50 Vca

Temps de chauffe 30 s

Kit de programmation HART® et
Loop Link 5905A

Rapport signal / bruit Min. 60 dB

Temps de réponse (programmable) 1...60 s

Vérification de l'EEPROM < 10 s

Dynamique du signal d'entrée 22 bit

Dynamique du signal de sortie 16 bit

Température d'étalonnage 20...28°C

Précision, la plus grande des valeurs générales et de base :

Valeurs générales		
Type d'entrée	Précision absolue	Coefficient de température
Tous	≤ ±0,05% de l'EC	≤ ±0,005% de l'EC / °C

Valeurs de base		
Type d'entrée	Précision de base	Coefficient de température
Pt100 et Pt1000	≤ ±0,1°C	≤ ±0,005°C/°C
Ni100	≤ ±0,2°C	≤ ±0,005°C/°C
R. Lin.	≤ ±0,1 Ω	≤ ±5 mΩ/°C
Volt	≤ ±10 μV	≤ ±0,5 μV/°C
Type TC : E, J, K, L, N, T, U	≤ ±0,5°C	≤ ±0,025°C/°C
Type TC : B, R, S, W3, W5	≤ ±1°C	≤ ±0,1°C/°C

Immunité CEM.....	< ±0,1% de l'EC
Immunité CEM améliorée :	
NAMUR NE 21, critère A, burst	< ±1% de l'EC

Effet d'une variation

de la tension d'alimentation < 0,005% de l'EC / Vcc

Vibration IEC 68-2-6 Test FC

Lloyd specification no. 1 4 g / 2...100 Hz

Taille max. des fils 1 x 1,5 mm²

Humidité < 95% HR (sans cond.)

Dimensions..... Ø 44 x 20,2 mm

Étanchéité (boîtier / bornier)..... IP68 / IP00

Poids 50 g

Spécifications électriques, entrée :

Décalage max. 50% de la valeur numérique
max. sélec.

Entrée RTD et entrée résistance linéaire :

Type RTD	Température min.	Température max.	Plage min.
Pt100	-200°C	+850°C	10°C
Ni100	-60°C	+250°C	10°C
R. Lin.	0 Ω	7000 Ω	25 Ω

Résistance de ligne max. par fil..... 5 Ω
 Courant de sonde Nom. 0,2 mA
 Effet de la résistance de ligne (3- / 4-fils).... < 0,002 Ω/Ω
 Détection de rupture sonde Oui
 Détection de court-circuit Si 0% > 30 Ω

Entrée TC :

Type	Température min.	Température max.	Plage min.	Norme
B	+400°C	+1820°C	100°C	IEC584
E	-100°C	+1000°C	50°C	IEC584
J	-100°C	+1200°C	50°C	IEC584
K	-180°C	+1372°C	50°C	IEC584
L	-100°C	+900°C	50°C	DIN 43710
N	-180°C	+1300°C	50°C	IEC584
R	-50°C	+1760°C	100°C	IEC584
S	-50°C	+1760°C	100°C	IEC584
T	-200°C	+400°C	50°C	IEC584
U	-200°C	+600°C	50°C	DIN 43710
W3	0°C	+2300°C	100°C	ASTM E988-90
W5	0°C	+2300°C	100°C	ASTM E988-90

Compensation de soudure froide (CSF) < ±1,0°C
 CSF externe avec Ni100 ou Pt100 -40 ≤ T_{amb.} ≤ 135°C
 Détection de rupture sonde Oui
 Courant de sonde :
 Pendant la détection..... Nom. 33 µA
 Si non..... 0 µA
 Détection de court-circuit Si 0% > 5 mV

Entrée tension :

Gamme de mesure..... -800...+800 mV
 Plage de mesure min. 2,5 mV
 Résistance d'entrée 10 MΩ

Sortie courant :

Gamme de mesure..... 4...20 mA
 Plage de mesure min. 16 mA
 Temps de scrutation..... 440 ms
 (660 ms pour diff.)
 Signal sortie fixe..... Entre 4 et 20 mA
 Sortie en cas de corruption de l'EEPROM.... ≤ 3,5 mA
 Résistance de charge..... ≤ (V_{alim.} - 8) / 0,023 [Ω]
 Stabilité de charge < ±0,01% de l'EC / 100 Ω

Détection de rupture de sonde :

Programmable 3,5...23 mA
 NAMUR NE43 Haut d'échelle 23 mA
 NAMUR NE43 Bas d'échelle..... 3,5 mA

Caractéristiques S.I. :

Sortie signal / alimentation, borne 1 à 2:

U_i..... : 30 Vcc
 I_i..... : 120 mAcc
 P_i..... : 0,84 W
 L_i..... : 10 µH
 C_i..... : 1,0 nF

Entrée capteur, borne 3, 4, 5 et 6:

U_o..... : 9,6 Vcc
 I_o..... : 28 mA
 P_o..... : 67 mW
 L_o..... : 35 mH
 C_o..... : 3,5 µF

Approbation EEx CENELEC :

DEMKO 99 ATEX 126965
 ATEX 0539  II 1 G
 EEx ia IIC T1...T6

Température amb. max. (T1...T4) 85°C
 Température amb. max. (T5 et T6)..... 60°C
 Zones d'application..... 0, 1 ou 2
FM IS, CL. I, DIV. 1, GP. A-D
 Entity, FM Control Drawing No. 5300Q502
CSA Class I, Zone 0/1, Group IIC
 Installation Drawing No. 533XQC03

Agréments et homologations :

Standard :

EMC 89/336/CEE, Emission EN 50 081-1, EN 50 081-2
 Immunité EN 50 082-2, EN 50 082-1
 Emission et immunité EN 61 326
 ATEX 94/9/CE EN 50 014 et EN 50 020
 Factory Mutual, ASCN 3600, 3810, 3611, 3610
 CSA, CAN / CSA E79-15, E79-11

EC = Echelle configurée

Connexions :

Entrée :

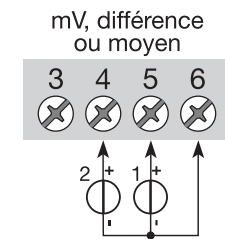
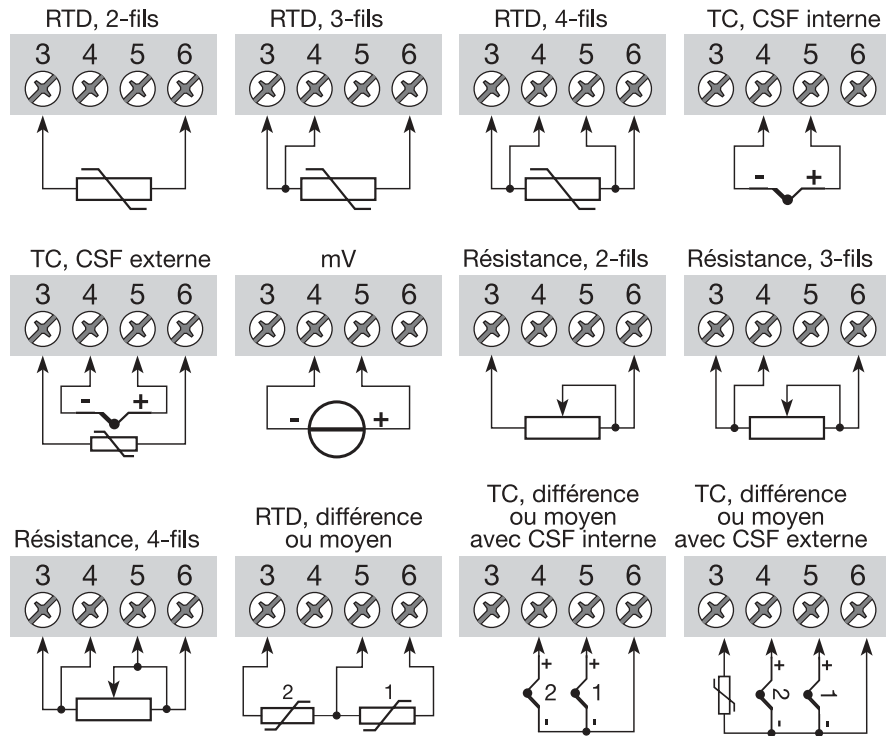

Sortie :

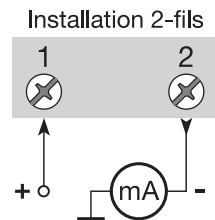

SCHEMA DE PRINCIPLE :

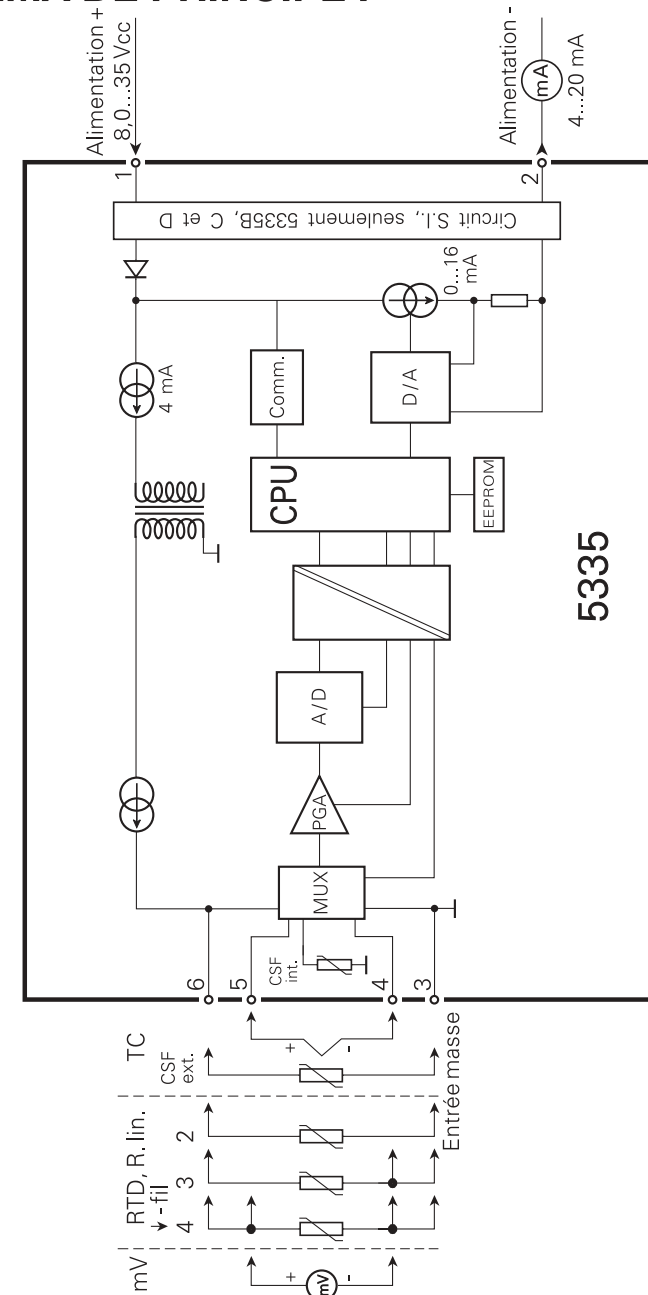

Programmation :

Le PRetop 5335 peut être programmé des 3 manières suivantes :

- 1 Avec le kit de programmation Loop Link 5905A et le logiciel PReset de PR electronics A/S.
2. Avec le modem HART® et le logiciel PReset.
3. Avec le communicateur HART® chargé avec le DDL de PR electronics A/S.

1 : Loop Link 5905A :

Pour le raccordement du Loop Link 5905A, veuillez vous reporter au schéma ci-dessous et à l'aide en ligne du logiciel PReset.

Loop Link 5905A ne doit pas être utilisé pour communication avec des modules installés en zone dangereuse.

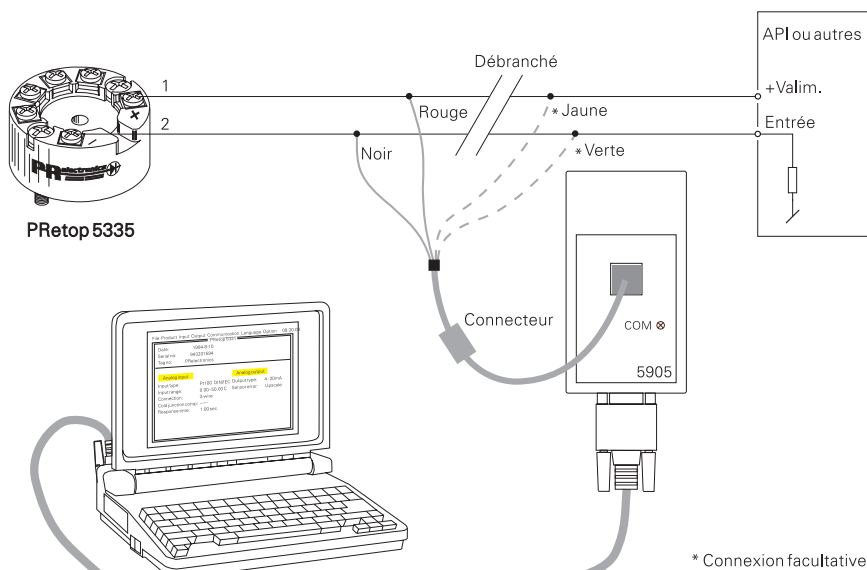

2 : Modem HART® :

Pour le raccordement veuillez vous reporter au schéma ci-dessous et à l'aide en ligne du logiciel PReset.

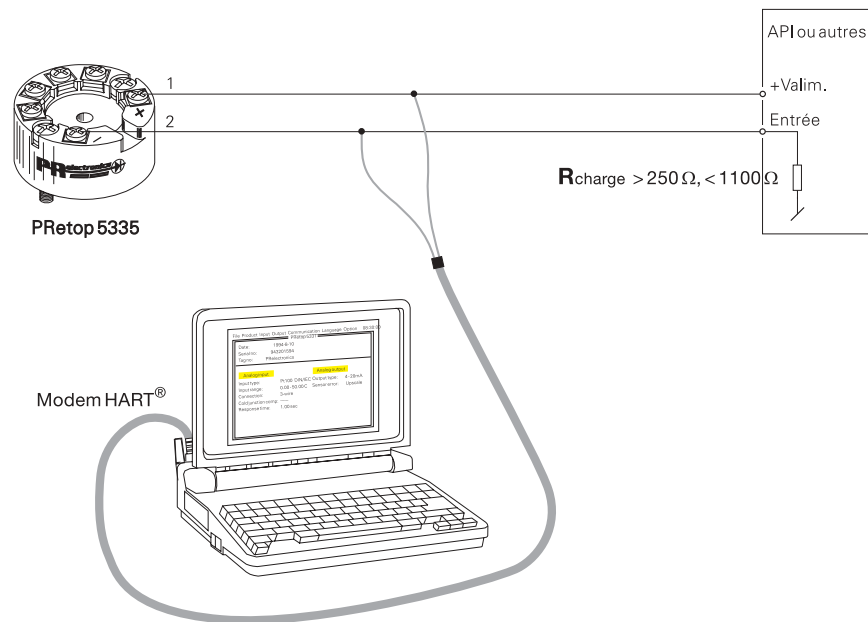

3 : Communicateur HART® :

Pour le raccordement veuillez vous reporter au schéma ci-dessous. Pour avoir accès à tous les paramètres, le communicateur HART® doit être chargé avec le DDL spécifique du PR electronics A/S. Ce DDL peut être commandé chez PR electronics A/S ou chez la Fondation HART®.

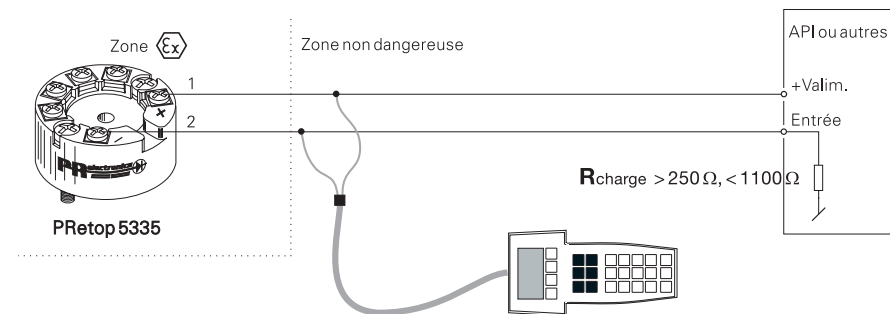

Raccordement des transmetteurs en multi-addressage :

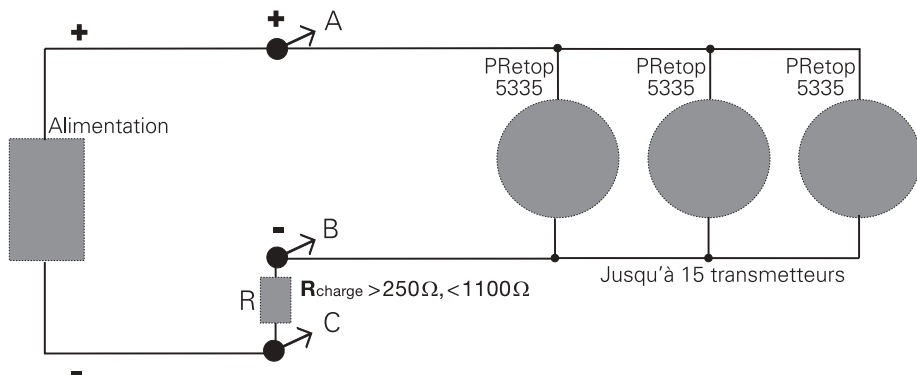

Le communicateur HART® ou le modem peuvent être connectés sur les points AB ou sur les points BC.

Pour la communication digitale HART® de 2-fils, les sorties de 15 transmetteurs au maximum peuvent être connectés en parallèle.

Chaque transmetteur sera doté d'un numéro unique entre 1 et 15. Si 2 transmetteurs ont le même numéro, tous les deux seront ignorés. Programmés pour multi-addressage, les sorties des transmetteurs seront bloquées à 4 mA, et le courant max. dans la boucle sera donc de 60 mA.

La communication se fait ensuite soit avec le communicateur HART® ou le modem HART®.

Le logiciel PReset peut configurer le transmetteur individuel en multi-addressage et lui donner un adressage unique.

Dimensions mécaniques :

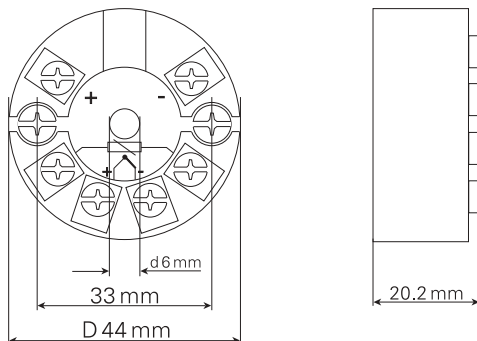

2-DRAHT MESSUMFORMER MIT HART® PROTOKOLL

PRetop 5335

Inhaltsverzeichnis

Sicherheitsinstruktion	44
Konformitätserklärung	45
Verwendung.....	46
Technische Merkmale.....	46
Montage / Installation.....	46
Anwendungen	47
Bestellangaben.....	48
Elektrische Daten	48
Anschlüsse	52
Blockdiagramm	53
Programmierung.....	54
Parallelanschluss von Signalgebern (Multidrop)	56
Abmessungen	56
Appendix:	
FM Control Drawing No. 5300Q502	58
CSA Installation Drawing No. 533XQC03	62

Sicherheitsinstruktion

- **Ex-Installation:**

Für sichere Installation von 5335B in explosionsgefährdeter Umgebung muss folgendes beobachtet werden. Die Installation muss nur von qualifizierten Personen, die mit den nationalen und internationalen Gesetze, Direktiven und Standards des Gebiets bekannt sind, vorgenommen werden.

KONFORMITÄTSERKLÄRUNG

Als Hersteller bescheinigt

PR electronics A/S

Lerbakken 10

DK-8410 Rønde

hiermit für das folgende Produkt:

Typ: 5335

Name: 2-Draht Messumformer mit HART® Protokoll

die Konformität mit folgenden Richtlinien und Normen:

EMV Richtlinien 89/336/EEC und nachfolgende Änderungen

Ab der Serien-Nr.: 990904001 ff.

EN 61 326

EN 50 081-1, EN 50 081-2

EN 50 082-1, EN 50 082-2

Diese Erklärung ist in Übereinstimmung mit Artikel 10, Unterklausel 1 der EMV Richtlinie ausgestellt. Zur Spezifikation des zulässigen Erfüllungsgrades, siehe die Elektrische Daten des Moduls.

Die ATEX Richtlinien 94/9/EC und nachfolgende Änderungen

Ab der Serien-Nr.: 990904001 ff.

EN 50 014 und EN 50 020

Ex Zertifikat: 99 ATEX 126965

Zulassungsstelle für CENELEC/ATEX: **UL International Demko A/S 0539**

Rønde, 4. Jan. 2000



Peter Rasmussen
Unterschrift des Herstellers

2-DRAHT MESSUMFORMER MIT HART® PROTOKOLL

PRetop 5335

- Eingang für WTH, TE, Ω oder mV
- Extreme Messgenauigkeit
- HART® Kommunikation
- Galvanische Trennung
- Für Einbau in Anschlusskopf DIN Form B

Verwendung:

- Linearisierte Temperaturmessung mit Pt100...Pt1000, Ni100...Ni1000 oder Thermoelementsensoren.
- Temperaturdifferenzen oder eine Durchschnittstemperaturmessung von 2 Widerstands- oder TE-Sensoren.
- Umwandlung von linearer Widerstandsänderung in ein analoges Standard-Stromsignal, z.B. von Ventilen oder Niveau-Messwertgeber.
- Verstärkung von bipolaren mV-Signalen zu einem Standard 4...20 mA Stromsignal.
- Bis zu fünfzehn Umformer können in einem Multidrop-System parallel verbunden werden mit HART® Kommunikation.

Technische Merkmale:

- PR5335 kann vom Benutzer innerhalb von wenigen Sekunden zur Messung in allen genormten Temperaturbereiche programmiert werden.
- Der WTH- und Widerstandseingang haben Leitungskompensation bei 2-, 3- oder 4-Leiter-Anschluss.
- Die gespeicherten Daten werden laufend kontrolliert.
- Fehlerfehlererkennung in Übereinstimmung mit der Richtlinien der NAMUR NE 89.

Montage / Installation:

- Für Einbau in Anschlusskopf DIN Form B oder Montage auf DIN-Schiene mittels eines speziellen Beschlages.
- **NB:** Als Ex-Sicherheitsbarriere für 5335B empfehlen wir 5106B.

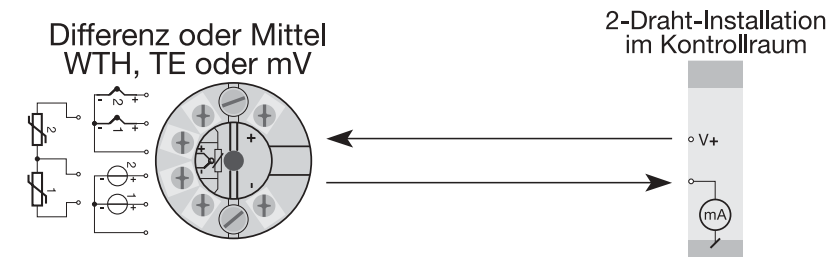
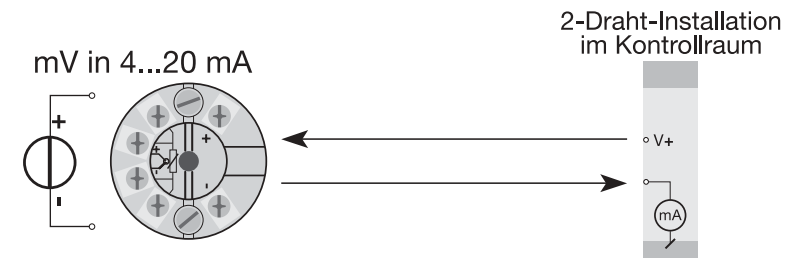
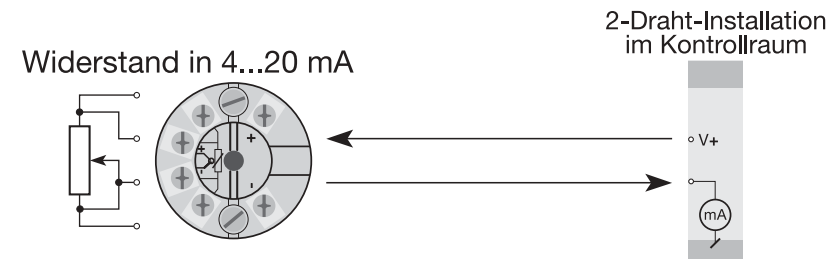
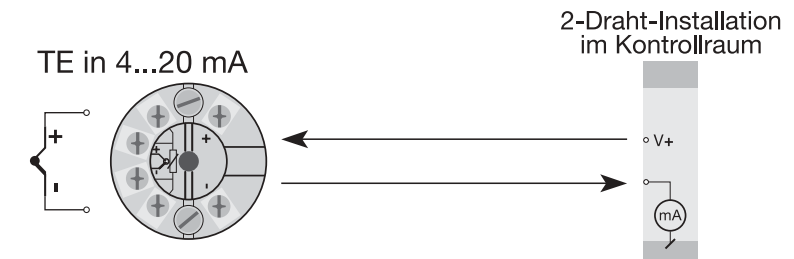
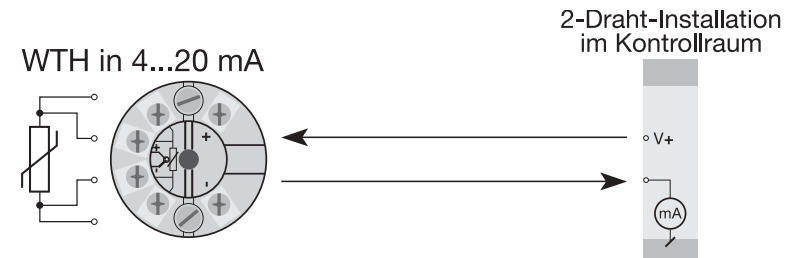

Bestellangaben: 5335

Typ	Version
5335	Standard : A
	ATEX : B
	FM und ATEX : C
	CSA, FM und ATEX : D

Elektrische Daten:

Spezifikationsbereich:

(@: -40°C bis +85°C)

Gemeinsame Daten:

Versorgungsspannung, DC

Standard 8,0...35 V

ATEX, FM und CSA, 5335B, C und D.. 8,0...28 V

Isolationsspannung, Test / Betrieb..... 1,5 kVAC / 50 VAC

Aufwärmzeit..... 30 s

Kommunikationsschnittstelle HART® und
Loop Link 5905A

Signal- / Rauschverhältnis Min. 60 dB

Ansprechzeit (programmierbar)..... 1...60 s

EEProm Fehlerkontrolle < 10 s

Signalauflösung, Eingang..... 22 Bit

Signalauflösung, Ausgang..... 16 Bit

Kalibrierungstemperatur..... 20...28°C

Genauigkeit, höherer Wert von allgemeinen und Grundwerten:

Allgemeine Werte		
Eingangsart	Absolute Genauigkeit	Temperaturkoeffizient
Alle	≤ ±0,05% d. Messsp.	≤ ±0,005% d. Messsp./°C

Grundwerte		
Eingangsart	Grund-Genauigkeit	Temperaturkoeffizient
Pt100 und Pt1000	≤ ±0,1°C	≤ ±0,005°C/°C
Ni100	≤ ±0,2°C	≤ ±0,005°C/°C
Lin. R	≤ ±0,1 Ω	≤ ±5 mΩ/°C
Volt	≤ ±10 µV	≤ ±0,5 µV/°C
TE-Typ: E, J, K, L, N, T, U	≤ ±0,5°C	≤ ±0,025°C/°C
TE-Typ: B, R, S, W3, W5	≤ ±1°C	≤ ±0,1°C/°C

EMV-Immunitätswirkung	< ±0,1% d. Messsp.
Erweiterte EMV-Immunität: NAMUR NE 21, A Kriterium, Burst.....	< ±1% d. Messsp.

Einfluss von Änderung der

Versorgungsspannung..... < 0,005% d. Messsp. / VDC

Vibration IEC 68-2-6 Test FC

Lloyd's Spezifikation Nr. 1 4 g / 2...100 Hz

Max. Leitungsquerschnitt..... 1 x 1,5 mm²

Luftfeuchtigkeit..... < 95% RH (nicht kond.)

Maß Ø 44 x 20,2 mm

Dichtheit (Gehäuse / Anschluss) IP68 / IP00

Gewicht 50 g

Elektrische Daten, Eingang:

Max. Nullpunktverschiebung (Offset)..... 50% des gewählten numerischen
Maximalwertes

WTH- und Linearer Widerstandseingang:

WTH-Typ	Min. Wert	Max. Wert	Min. Spanne
Pt100	-200°C	+850°C	10°C
Ni100	-60°C	+250°C	10°C
Lin. R	0 Ω	7000 Ω	25 Ω

Leitungswiderstand pro Leiter (Max.)..... 5 Ω
 Sensorstrom Nom. 0,2 mA
 Wirkung des Fühlerkabelwiderstandes
 (3- / 4-Leiter) < 0,002 Ω/Ω
 Fühlerfehlererkennung..... Ja
 Kurzschlusserkennung Falls 0% > 30 Ω

TE-Eingang:

Typ	Min. Temperatur	Max. Temperatur	Min. Spanne	Norm
B	+400°C	+1820°C	100°C	IEC584
E	-100°C	+1000°C	50°C	IEC584
J	-100°C	+1200°C	50°C	IEC584
K	-180°C	+1372°C	50°C	IEC584
L	-100°C	+900°C	50°C	DIN 43710
N	-180°C	+1300°C	50°C	IEC584
R	-50°C	+1760°C	100°C	IEC584
S	-50°C	+1760°C	100°C	IEC584
T	-200°C	+400°C	50°C	IEC584
U	-200°C	+600°C	50°C	DIN 43710
W3	0°C	+2300°C	100°C	ASTM E988-90
W5	0°C	+2300°C	100°C	ASTM E988-90

Vergleichstellenkompensation (CJC)..... < ±1,0°C
 Externe CJC mit Ni100 oder Pt100 -40 ≤ T_{Umg.} ≤ 135°C
 Fühlerfehlererkennung..... Ja
 Fühlerfehlerstrom:
 Bei Erkennung..... Nom. 33 µA
 Sonst..... 0 µA
 Kurzschlusserkennung Falls 0% > 5 mV

Spannungseingang:

Messbereich -800...+800 mV
 Min. Messbereich (Spanne)..... 2,5 mV
 Eingangswiderstand 10 MΩ

Stromausgang:

Signalbereich..... 4...20 mA
 Min. Signalbereich..... 16 mA
 Aktualisierungszeit 440 ms
 (660 ms für Diff.)
 Festes Ausgangssignal Zwischen 4 und 20 mA
 Ausgangssignal bei EEPROMfehler ≤ 3,5 mA
 Belastungswiderstand..... ≤ (U_{Versorg.} - 8) / 0,023 [Ω]
 Belastungsstabilität < ±0,01% d. Messsp. / 100 Ω

Sensorfehlanzeige:

Programmierbar 3,5...23 mA
 NAMUR NE43 aufsteuernd 23 mA
 NAMUR NE43 zusteuernd 3,5 mA

Ex-Daten:

Signal Ausgang / Versorgung, Klemmen 1 bis 2:
 U_i..... : 30 VDC
 I_i..... : 120 mADC
 P_i..... : 0,84 W
 L_i..... : 10 µH
 C_i..... : 1,0 nF
 Fühlereingang, Klemmen 3, 4, 5 und 6:
 U_o..... : 9,6 VDC
 I_o..... : 28 mA
 P_o..... : 67 mW
 L_o..... : 35 mH
 C_o..... : 3,5 µF

EEx-Zulassung CENELEC:

DEMKO 99 ATEX 126965
ATEX 0539  II 1 G
 EEx ia IIC T1...T6
 Max. Umgebungstemp. für T1...T4 85°C
 Max. Umgebungstemp. für T5 und T6..... 60°C
 Anwendungsbereich in zone 0, 1 oder 2
FM IS, CL. I, DIV. 1, GP. A-D
 Entity, FM Control Drawing No. 5300Q502
CSA Class I, Zone 0/1, Group IIC
 Installation Drawing No. 533XQC03
Eingehaltene Behördenvorschriften: **Norm:**
 EMV 89/336/EWG, Emission..... EN 50 081-1, EN 50 081-2
 Immunität EN 50 082-2, EN 50 082-1
 Emission und Immunität EN 61 326
 ATEX 94/9/EG..... EN 50 014 und EN 50 020
 Factory Mutual, ASCN 3600, 3810, 3611, 3610
 CSA, CAN / CSA E-79-15, E79-11

d. Messspanne = der gewählten Messspanne

Anschlüsse:

Eingang:

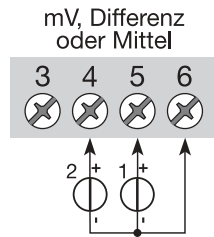
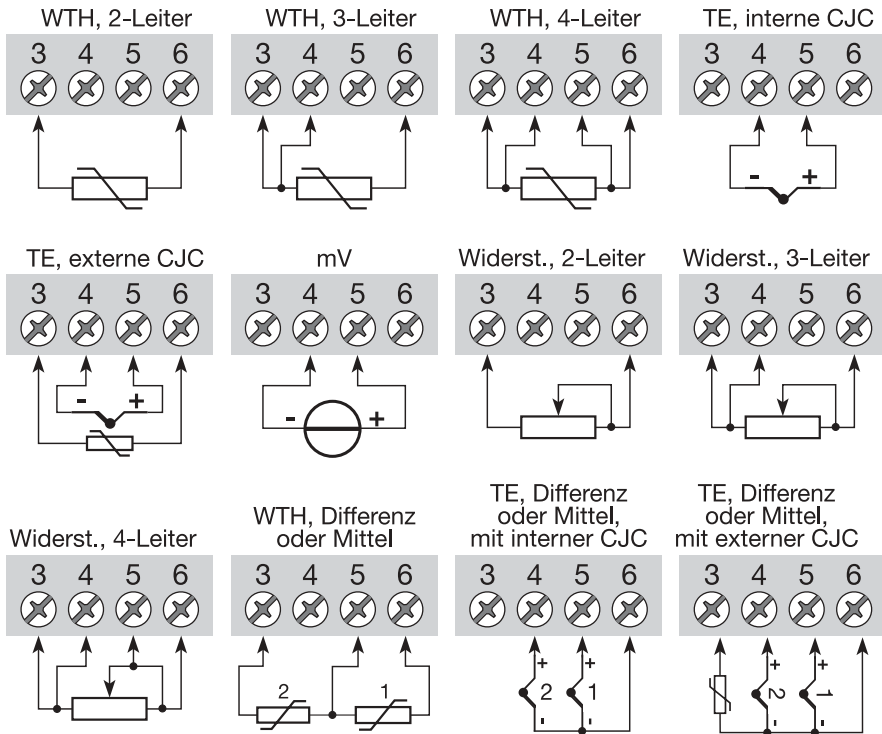

Ausgang:

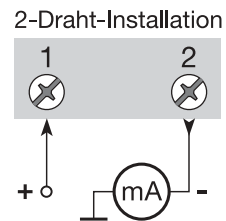

BLOCKDIAGRAMM:

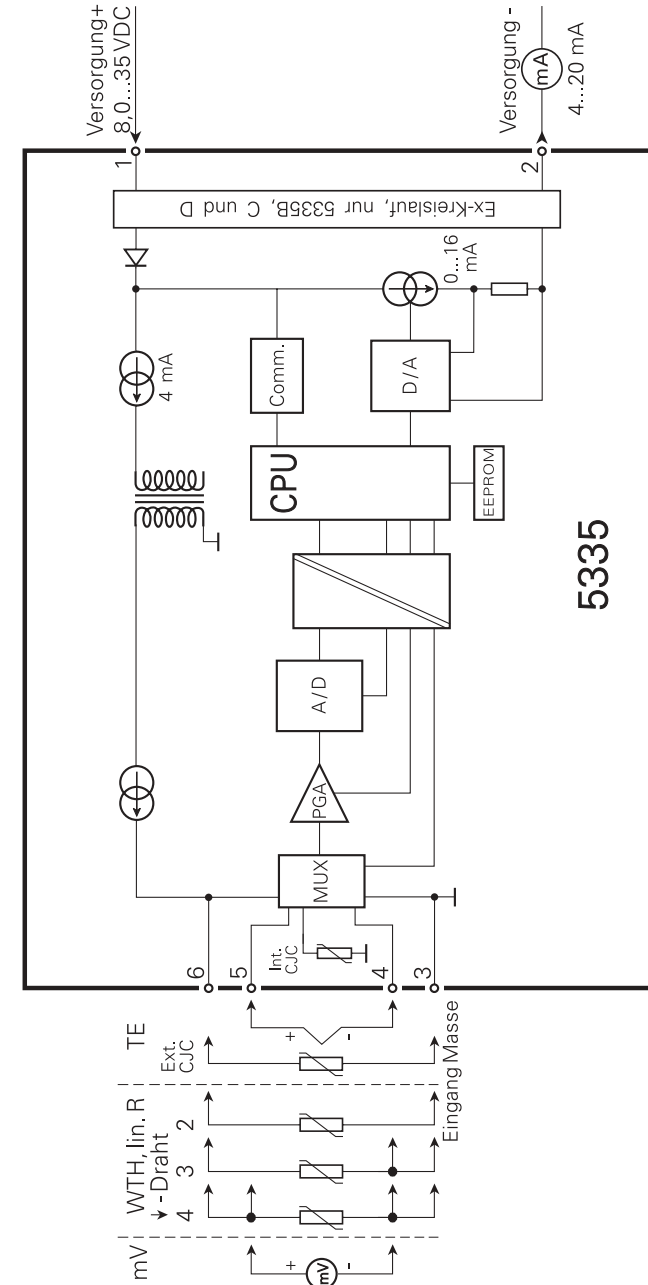

Programmierung:

PRetop 5335 kann in 3 verschiedener Weise programmiert werden:

1. Mittels PR electronics A/S' Kommunikationsschnittstelle Loop Link 5905A und PReset PC Programmierungssoftware.
2. Mittels HART® Modem und PReset PC Programmierungssoftware.
3. Mittels HART® Datenaustauschgerät mit PR electronics A/S' DDL-Antrieb.

1: Loop Link 5905A:

Bezüglich Programmierung verweisen wir auf die nachfolgende Zeichnung und die "Hilfe"-Funktion im PReset-Programm.

Loop Link 5905A darf nicht zur Kommunikation mit Modulen, die in Ex-gefährdeten bereichen installiert sind, benutzt werden.

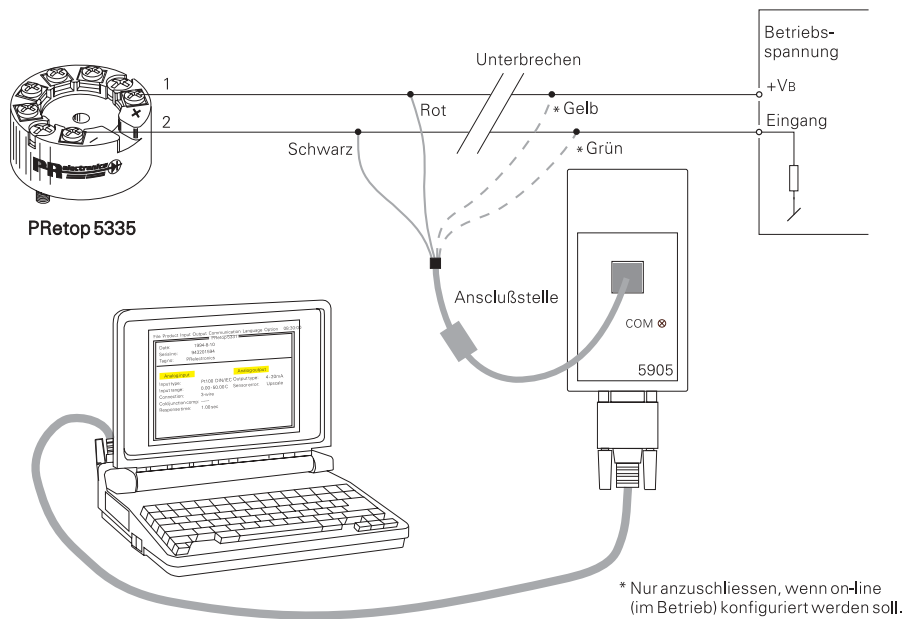

2: HART® Modem:

Bezüglich Programmierung verweisen wir auf die nachfolgende Zeichnung und die "Hilfe"-Funktion im PReset-Programm.

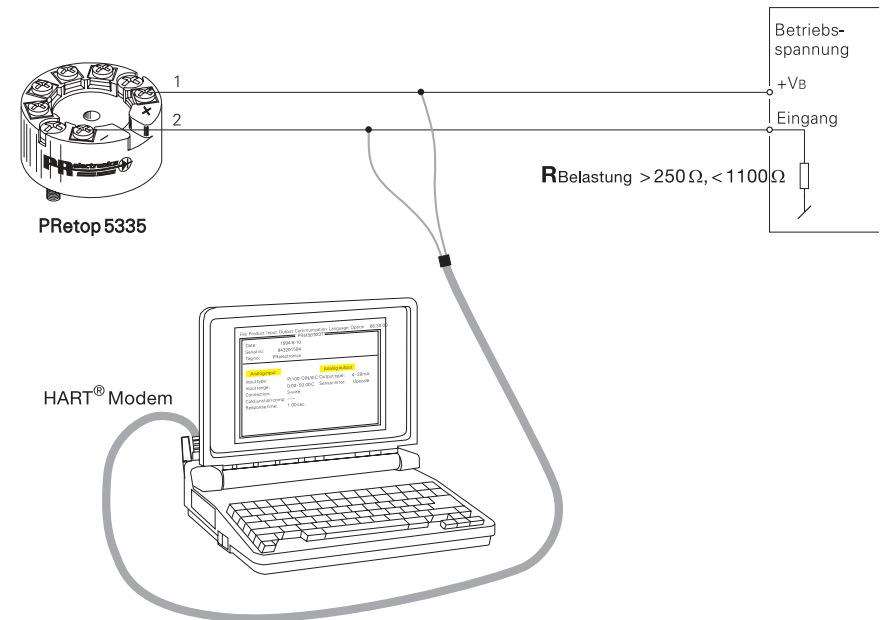

3: HART® Datenaustauschgerät:

Bezüglich Programmierung verweisen wir auf die nachfolgende Zeichnung. Um Zutritt zur produktspezifischen Kommandos zu bekommen, muss das HART® Datenaustauschgerät mit dem DDL-Antrieb von PR electronics A/S ausgestattet sein. Der Antrieb ist von HART® Communication Foundation oder PR electronics A/S erhältlich.

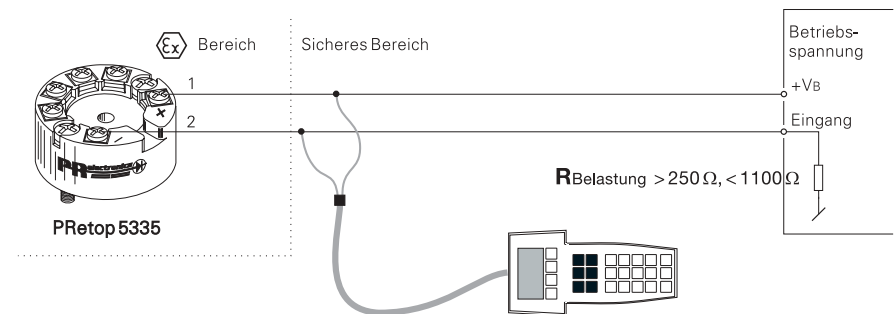

PARALLELANSCHLUSS VON SIGNALGEBERN (MULTIDROP):

Ein HART® Datenaustauschgerät oder ein PC-Modem kann über die Punkte AB oder BC angeschlossen werden.

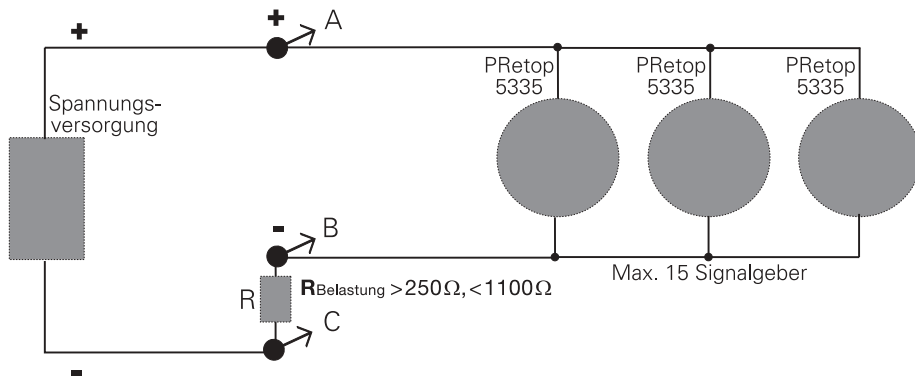

Im Ausgang können bis zu 15 Signalgeber für eine digitale Kommunikation über Zweileiter parallel geschaltet werden.

Jeder Signalgeber wird mit einer unverwechselbaren Nummer von 1 bis 15 konfiguriert. Wenn 2 Signalgeber mit der selben Nummer konfiguriert sind, werden sie beide ignoriert. Die Signalgeber müssen auf Multidropmodus (mit einem festen Ausgangssignal von 4 mA) programmiert werden. Der maximale Strom in der Schleife kann somit 60 mA betragen.

Die Kommunikation kann über ein HART®-Datenaustauschgerät oder HART®-Modem erfolgen.

Die PReset Software kann den einzelnen Signalgeber auf Multidropmodus einstellen und ihm eine unverwechselbare Adresse für wiederkehrende Abfrage (polling) zuteilen.

Abmessungen:

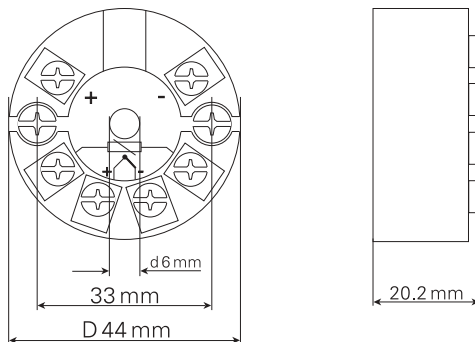

APPENDIX

FM Control Drawing No. 5300Q502

CSA Installation Drawing No. 533XQC03

Pretop 53xx FM Control Drawing.

5331C, 5331D, 5333C, 5333D, 5335C and 5335D transmitters are approved as intrinsically safe in Zone 0 Group IIC or Class I, Division 1, Group A, B, C, D when installed according to 53xx FM Control Drawing.

1. Connections with separate power supply and receiver.

Output: Standard 4 - 20mA loop

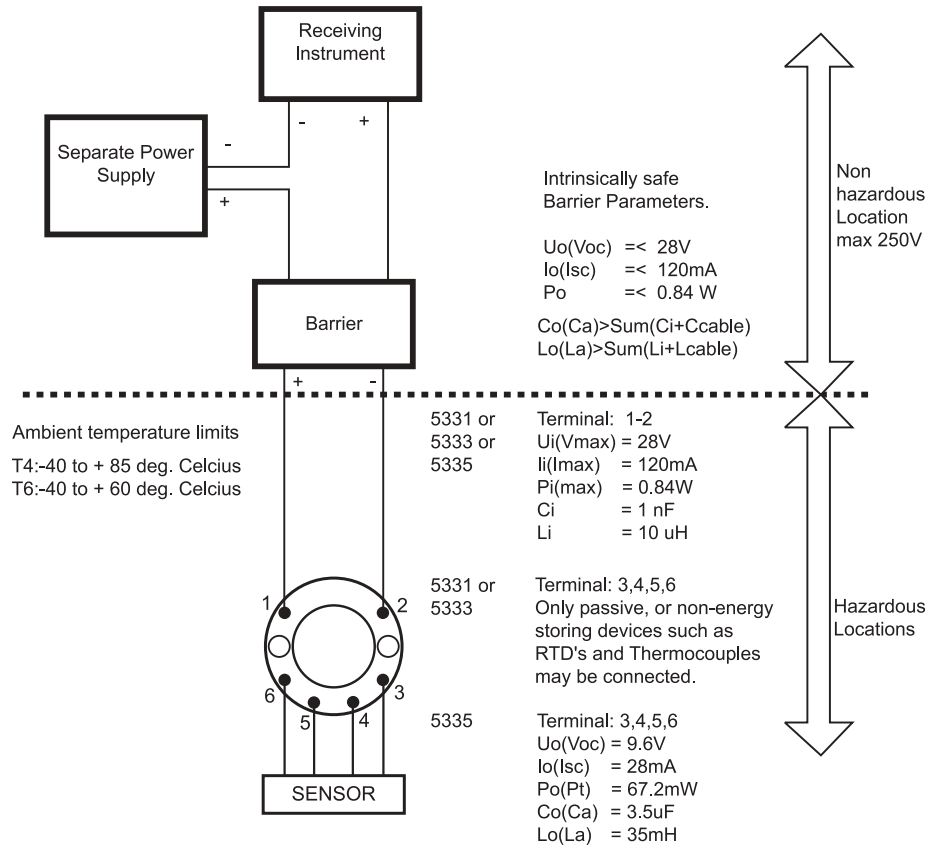

2. Connection with power supply and barrier built into receiver.

Output: Standard 4 - 20mA loop

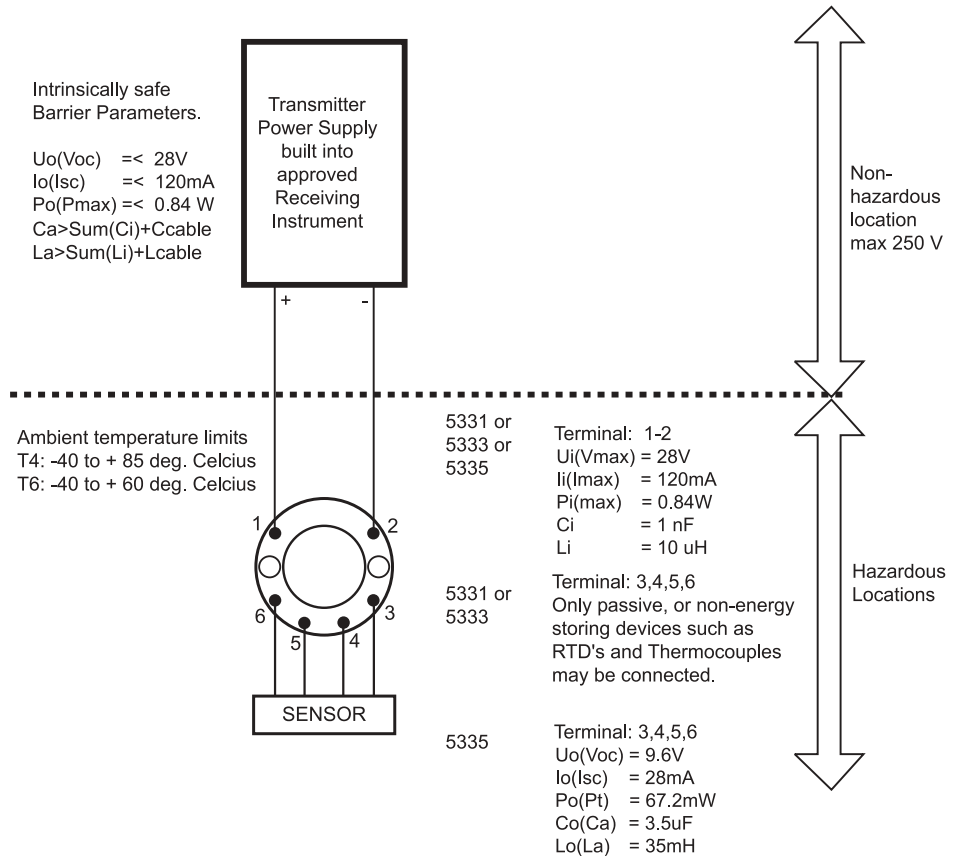

3. The entity concept.

Equipment that is FM-approved for intrinsic safety may be connected to barriers based on the ENTITY CONCEPT. This concept permits interconnection of approved transmitters, meters and other devices in combinations which have not been specifically examined by FM, provided that the agency's criteria are met. The combination is then intrinsically safe, if the entity concept is acceptable to the authority having jurisdiction over the installation.

The entity concept criteria are as follows:

The intrinsically safe devices, other than barriers, must not be a source of power.

The maximum voltage $U_i(V_{max})$ and current $I_i(I_{max})$, and maximum power $P_i(P_{max})$, which the device can receive and remain intrinsically safe, must be equal to or greater than the voltage (U_O or V_{oc} or V_t) and current (I_O or I_{sc} or I_t) and the power P_O which can be delivered by the barrier.

The sum of the maximum unprotected capacitance (C_i) for each intrinsically safe device and the interconnecting wiring must be less than the capacitance (C_a) which can be safely connected to the barrier.

The sum of the maximum unprotected inductance (L_i) for each intrinsically safe device and the interconnecting wiring must be less than the inductance (L_a) which can be safely connected to the barrier.

The maximum entity parameters U_i , I_i , P_i , C_i , and L_i for the Pretop 53xx Transmitters are listed on pages 1 and 2 of this document.

The entity parameters U_O , V_{oc} or V_t and I_O , I_{sc} or I_t , and C_a and L_a for barriers are provided by the barrier manufacturer.

CSA Intrinsic Safety Installation Drawing.

5331D, 5333D and 5335D transmitters are approved as intrinsically safe in Zone 0 Group IIC or Class I, Division 1, Group A, B, C, D when installed according to Installation Drawing.

1. Connections with separate power supply and receiver.

Output: Standard 4 - 20mA loop

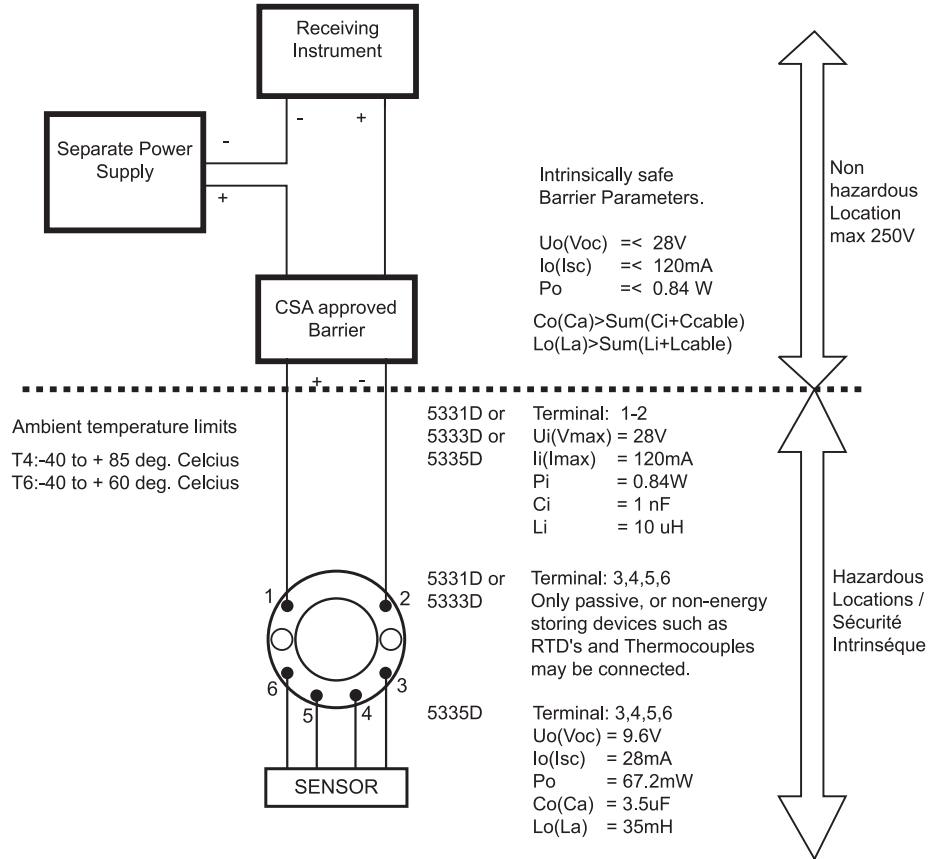

Warning:
 Substitution of components may impair intrinsic safety.
 The transmitters must be installed in a suitable enclosure to meet installation codes stipulated in the Canadian Electrical Code (CEC).

2. Connection with power supply and barrier built into receiver

Output: Standard 4 - 20mA loop

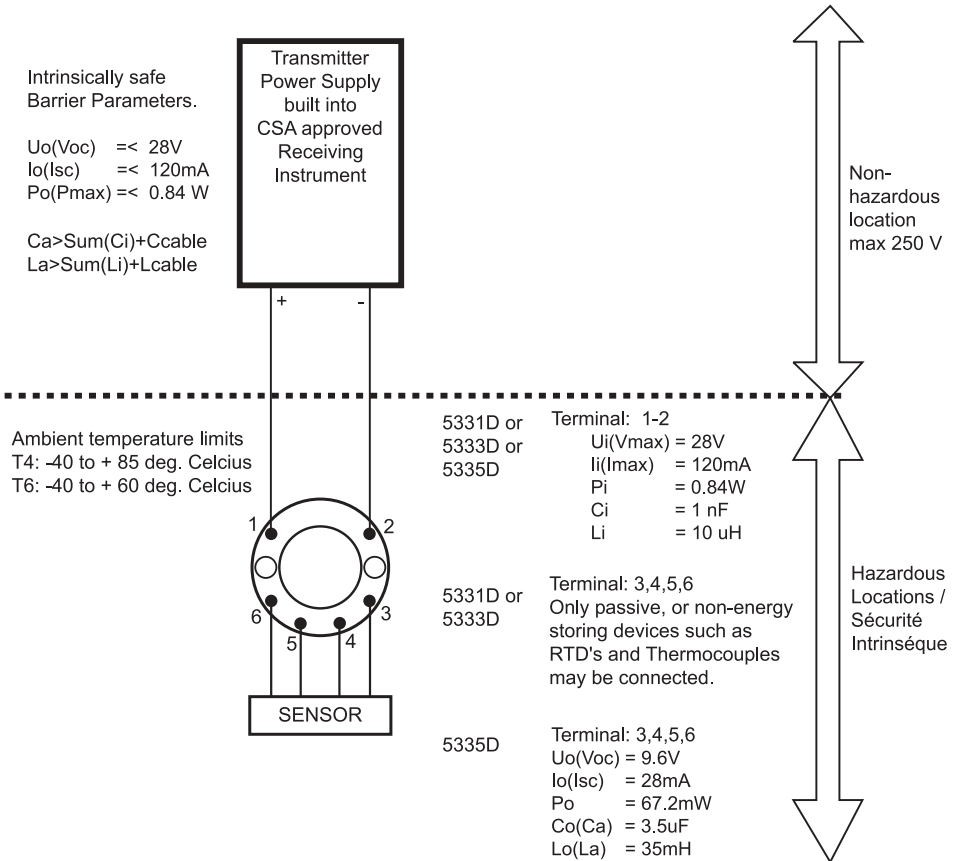

Warning:
 Substitution of components may impair intrinsic safety.
 The transmitters must be installed in a suitable enclosure to meet installation codes stipulated in the Canadian Electrical Code (CEC).

Head office

Denmark
PR electronics A/S
Lerbakken 10
DK-8410 Rønde
www.preelectronics.com
sales@preelectronics.dk
tel. +45 86 37 26 77
fax +45 86 37 30 85

Subsidiaries

France
PR electronics Sarl
Zac du Chêne, Activillage
2, allée des Sorbiers
F-69500 Bron
sales@preelectronics.fr
tel. +33 (0) 4 72 14 06 07
fax +33 (0) 4 72 37 88 20

Germany
PR electronics GmbH
Bamlerstraße 92
D-45141 Essen
sales@preelectronics.de
tel. +49 (0) 201 860 6660
fax +49 (0) 201 860 6666

Italy
PR electronics S.r.l.
Via Meli, 36
IT-20127 Milano
sales@preelectronics.it
tel. +39 02 2630 6259
fax +39 02 2630 6283

Spain
PR electronics S.L.
Avda. Meridiana 354, 6°-A
E-08027 Barcelona
sales@preelectronics.es
tel. +34 93 311 01 67
fax +34 93 311 08 17

Sweden
PR electronics AB
August Barks gata 6
S-421 32 Västra Frölunda
sales@preelectronics.se
tel. +46 (0) 3149 9990
fax +46 (0) 3149 1590

UK
PR electronics Ltd
20 Aubery Crescent, Largs
Ayrshire, KA30 8PR
sales@preelectronics.co.uk
tel. +44 (0) 1475 689 588
fax +44 (0) 1475 689 468

USA
PR electronics Inc
9 Elm Crest Road
Wakefield, MA 01880
bobpreelectronics@attbi.com
tel. +1 781 245-7182
fax +1 781 245-7183

DK ► PR electronics A/S tilbyder et bredt program af analoge og digitale signalbehandlingsmoduler til industriel automation. Vores kompetenceområder omfatter: Isolation, Displays, Ex-barrierer, Temperatur samt Backplanes. Alle produkter opfylder de strengeste internationale standarder, og størstedelen integrerer den patenterede STREAM-SHIELD teknologi, der sikrer driftsikkerhed i selv de værste omgivelser. Vores motto »Signals the Best« er indbegrebet af denne filosofi – og din garanti for kvalitet.

UK ► PR electronics A/S offers a wide range of analogue and digital signal conditioning modules for industrial automation. Our areas of competence include: Isolation, Displays, Ex barriers, Temperature, and Backplanes. All products comply with the most exacting international standards and the majority feature our patented STREAM-SHIELD technology ensuring reliability in even the worst of conditions. »Signals the Best« is the epitome of our philosophy – and your guarantee for quality.

FR ► PR electronics A/S offre une large gamme de produits pour le traitement des signaux analogiques et numériques dans tous les domaines industriels. Nos compétences s'étendent des transmetteurs de température aux afficheurs, des isolateurs aux barrières SI, jusqu'aux platines de montage. Tous nos produits sont conformes aux normes internationales les plus strictes et la majorité d'entre eux répondent même à la technologie brevetée STREAM-SHIELD qui garantit un fonctionnement fiable sous les conditions les plus défavorables. Notre devise »SIGNALS the BEST« c'est notre ligne de conduite - et pour vous l'assurance de la meilleure qualité.

DE ► PR electronics A/S verfügt über ein breites Produktprogramm an analogen und digitalen Signalverarbeitungsmodulen für die industrielle Automatisierung. Unsere Kompetenzbereiche umfassen: Displays, Temperaturtransmitter, Ex- und galvanische Signaltrenner. Alle Produkte von PR electronics werden in Übereinstimmung mit den strengsten internationalen Normen produziert. Für die Mehrzahl aller Produkte garantiert die patentierte STREAM-SHIELD Technologie höchste Zuverlässigkeit auch unter schwierigsten Einsatzbedingungen. »Signals the Best« ist Ihre Garantie für Qualität!



Quality System
DS/EN ISO 9001

