



**5 3 4 3**

**2-tråds  
niveautransmitter**

Nr. 5343V106-DK  
Fra serienr. 141298001



## Revision Notes

The following list provides notes concerning revisions of this document.

<b>Rev. ID</b>	<b>Date</b>	<b>Notes</b>
104	14/14	IECEX, FM and INMETRO approvals added
105	15/03	GL marine approval added
106	17/07	IECEX, FM and INMETRO installation drawings updated

# 2-TRÅDS NIVEAUTRANSMITTER

5343

## INDHOLDSFORTEGNELSE

Anvendelse.....	2
Teknisk karakteristik .....	2
Montage / installation.....	2
Applikationer .....	3
Bestillingsskema: 5343.....	4
Elektriske specifikationer .....	4
Tilslutninger.....	7
Blokdiagram .....	8
Programmering .....	9
Mekaniske specifikationer.....	9
Montering af følerledninger .....	9
Konfigurering af potentiometerindgang .....	10
Aktivering af indbyggede lineariseringer .....	12
Appendix .....	13
ATEX Installation Drawing - 5343A .....	14
ATEX Installation Drawing - 5343B .....	15
IECEX Installation Drawing - 5343A.....	17
IECEX Installation Drawing - 5343B.....	18
FM Installation Drawing - 5343B.....	20
INMETRO Instruções de Segurança - 5343A.....	22
INMETRO Instruções de Segurança - 5343B.....	23

## 2-TRÅDS NIVEAUTRANSMITTER 5343

- *Indgang for potentiometer eller Ohm*
- *Programmerbar følerfejlsværdi*
- *Høj målenøjagtighed*
- *Unik proceskalibreringsfunktion*
- *Programmerbar via PC*

### Anvendelse

- Konvertering af modstandsændringer til standard analogt strømsignal f.eks. fra Ohmske niveaustave eller potentiometre i ventildrev.
- Brugerdefineret lineariseringsfunktion kan aktiveres.

### Teknisk karakteristik

- PR5343 kan af brugeren i løbet af få sekunder programmeres til at måle inden for de opgivne Ohmske værdier.
- Der er løbende sikkerhedscheck af gemte data.
- Modulet er beskyttet mod tilslutning af forkert forsyningspolaritet.
- PR5343 konfigureres til den aktuelle opgave ved hjælp af en PC, PRelevel-softwaren og kommunikationsinterfacet Loop Link.
- PRelevel-konfigurationsværktøjet, der er en del af PReset-softwaren, er specielt designet til konfigurering af niveau-applikationer. Blandt andet findes der en funktion til "on line" måling af indgangsspan samt lineariseringsfunktion til volumenlineær udgang fra vandretliggende cylindriske tanke.

### Montage / installation

- Kan monteres i DIN form B følerhoved. I ikke-eksplosionsfarlige områder kan 5343 monteres på en DIN-skinne med et specielt beslag.

# APPLIKATIONER

Ohmsk niveaustav  
til 4...20 mA

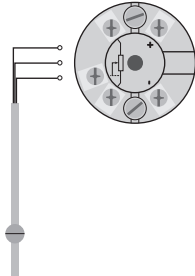

2-Trådsinstallation  
i kontrolrum

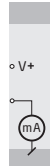

Potentiometer  
til 4...20 mA

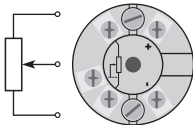

2-Trådsinstallation  
i kontrolrum

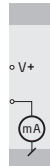

Modstand til 4...20 mA

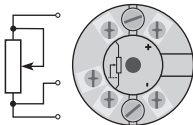

2-Trådsinstallation  
i kontrolrum

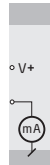

## Bestillingsskema: 5343

Type	Version
5343	Standard : A ATEX, FM, IECEx & INMETRO : B

### Elektriske specifikationer

#### Specifikationsområde:

-40°C til +85°C

#### Fælles specifikationer:

Forsyningsspænding, DC

Standard..... 8,0...35 V

ATEX, FM, IECEx & INMETRO ..... 8,0...30 V

Internt effekttab

Standard..... 25 mW...0,8 W

ATEX, FM, IECEx & INMETRO ..... 25 mW...0,7 W

Spændingsdrop..... 8 VDC

Opvarmningstid ..... 5 min.

Kommunikationsinterface ..... Loop Link

Signal- / støjforhold ..... Min. 60 dB

Reaktionstid (programmerbar) ..... 0,33...60 s

Signaldynamik, indgang ..... 19 bit

Signaldynamik, udgang ..... 16 bit

Kalibreringstemperatur ..... 20...28°C

Nøjagtighed, størst af generelle og basisværdier:

Generelle værdier		
Indgangstype	Absolut nøjagtighed	Temperaturkoefficient
Lin. R	$\leq \pm 0,1\%$ af span	$\leq \pm 0,01\%$ af span / °C

Basisværdier		
Indgangstype	Basisnøjagtighed	Temperaturkoefficient
Lin. R	$\leq \pm 0,05 \Omega$	$\leq \pm 0,002 \Omega / ^\circ\text{C}$

EMC-immunitetspåvirkning.....	$< \pm 0,5\%$ af span
-------------------------------	-----------------------

Virkning af forsyningsspændingsændring .....	$< 0,005\%$ af span / VDC
Vibration .....	IEC 60068-2-6 : 2007
2...25 Hz.....	$\pm 1,6$ mm
25...100 Hz .....	$\pm 4$ g
Max. ledningskvadrat .....	1 x 1,5 mm <sup>2</sup> flerkoret ledning
Luftfugtighed.....	$< 95\%$ RH (ikke kond.)
Mål .....	Ø 44 x 20,2 mm
Kapslingsklasse (hus / klemme) .....	IP68 / IP00
Vægt .....	50 g

### Elektriske specifikationer, indgang:

#### Lineær modstandsindgang:

Måleområde.....	0...100 kΩ
Min. måleområde (span) .....	1 kΩ
Max. nulpunktsforskydning (offset).....	50% af valgt max. værdi
Kabelmodstand pr. leder (max.).....	100 Ω
Følerstrøm.....	$> 25 \mu\text{A}$ , $< 120 \mu\text{A}$
Virkning af følerkabelmodstand (3-leder) .....	$< 0,002 \Omega / \Omega$
Følerfejlsdetektering.....	Ja

## Udgang:

### Strømdugang:

Signalområde.....	4...20 mA
Min. signalområde.....	16 mA
Opdateringstid.....	135 ms
Belastningsmodstand.....	$< (V_{\text{forsyn.}} - 8) / 0,023 [\Omega]$
Belastningsstabilitet.....	$< \pm 0,01\%$ af span/100 $\Omega$

### Følerfejlsdetektering:

Programmerbar.....	3,5...23 mA
NAMUR NE43 Upscale.....	23 mA
NAMUR NE43 Downscale.....	3,5 mA

**Af span** = Af det aktuelt valgte område

### Godkendelser:

EMC.....	2014/30/EU
RoHS.....	2011/65/EU
EAC.....	TR-CU 020/2011

### Marine-godkendelse:

DNV-GL, Ships & Offshore.....	Standard for Certification No. 2.4
-------------------------------	------------------------------------

### Ex / I.S.:

ATEX 2014/34/EU	
5343A.....	KEMA 10ATEX0004 X
5343B.....	KEMA 03ATEX1538 X
FM.....	FM17US0013X
IECEx.....	DEK 13.0036X
INMETRO.....	DEKRA 16.0014 X
EAC Ex TR-CU 012/2011.....	RU C-DK.GB08.V.00410



# TILSLUTNINGER

## Indgang:

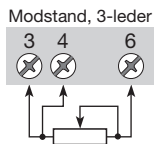
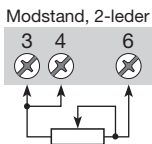
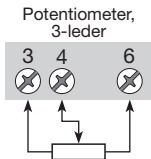

## Udgang:

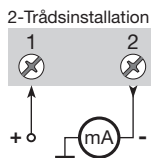

# BLOKDIAGRAM

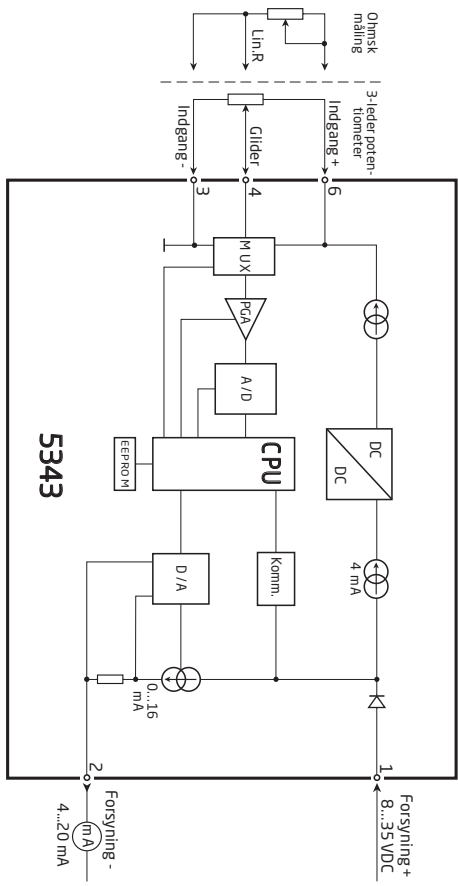

# PROGRAMMERING

- Loop Link er et batteridrevet kommunikationsinterface, der er nødvendigt for programmering af 5343.
- Ved programmering henvises til tegningen nedenfor og hjælpefunktionen i PRelevel-programmet.
- Loop Link må ikke benyttes til kommunikation med moduler installeret i Ex-område.

## Bestilling: Loop Link

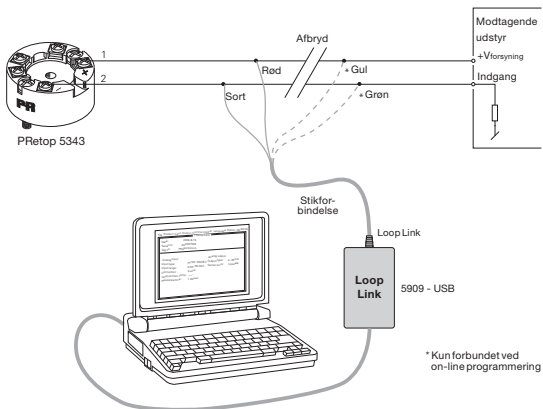

## Mekaniske specifikationer

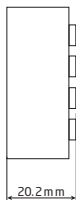
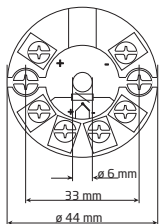

## Montering af følerledninger

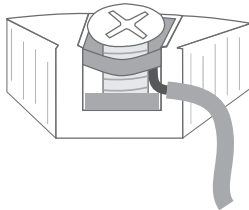

Ledninger monteres mellem metalpladerne

## KONFIGURERING AF POTENTIOMETERINDGANG

På en Ohmsk niveaustav ændres modstandsværdien ved en magnetisk flyders aktivering af stavens kontakter. Det betyder, at det oftest er umuligt at benytte hele niveaustaven som indgangsspænding. Når 5343 benyttes med potentiometerindgang, findes der i PRelevel-softwaren følgende specialfunktioner til konfiguration:

**[Calibration Password]** er 4711. Dette password bør indtastes ved programstart. De eneste parametre, der kan ændres uden passwordet, er Input Low og High for potentiometerindgang. Menupunktet findes under **Tools > Options**. Vær opmærksom på teksten i **'Information'** vinduet under transmittering. Når opsætningen ikke sendes på grund af manglende password, afsluttes der med teksten: 'Operation aborted.' 'Configuration NOT transmitted to the device.'

Beskrivelsen af opsætning med potentiometerindgang tager udgangspunkt i skitse 1. Vær opmærksom på, at PRelevel-softwaren kun findes i engelsksproget udgave. Derfor er menueteksterne skrevet, som de ses på skærmen. Vælg fanebladet **[Input]**:

**Skitse 1**, snit i vandretliggende cylindrisk tank

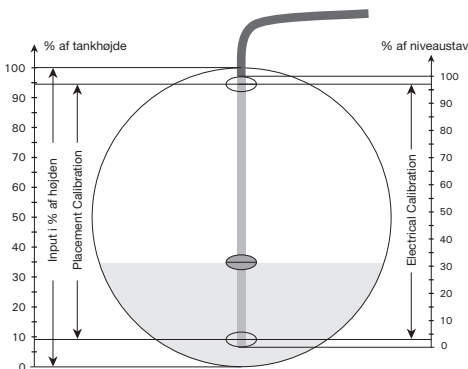

**[Electrical Calibration]** Her indtastes eller PRelevel måler det område på det tilsluttede potentiometer, som skal eller kan detekteres. Transmitteren skal være tilsluttet kommunikationsinterfacet Loop Link, for at værdierne kan måles. Værdierne på skitse 1 er Low = 3% og High = 97%.

**[Placement Calibration]** Her indtastes placeringen af 'Electrical Calibration' Low og High punkterne på niveaustaven i forhold til tankens højde. Disse værdier bruges dels til beregning af lineariseringsværdier og dels til kalkulation af 0 og 100% højde.

Værdierne på skitse 1 er Low = 9% og High = 94%.

**[Input]** Her indtastes det ønskede inputspan i forhold til højden. Når input Low og High er valgt til 0 og 100%, kan indgangen aldrig komme under 9% og over 94% på grund af niveaustavens udformning og montering. Hvis udgangsspannet er 4...20 mA, vil udgangen kun variere fra 5,44...19,04 mA.

Værdierne på skitse 1 er Low = 0% og High = 100%.

## AKTIVERING AF INDBYGGEDE LINEARISERINGER

PRElevel-softwaren har indbyggede lineariseringsfunktioner for vandretliggende cylindrisk tank og kugletank. Lineariseringsfunktionerne kan aktiveres på følgende måde:

**Custom indgangstype:** For at få adgang til kundebestemt linearisering skal vælges i **[General Type]** indgangsfeltet ende med teksten 'Custom' og **[Calibration Password]** 4711 være indtastet.

**Aktivering af linearisering:** I PRElevel 5343 vinduet vælges fanebladet **[Options]**. Hvis en af de indbyggede lineariseringer ønskes anvendt, skal der i 'Linearisation' vinduet vælges "Polynomial.....(Relative)" for at hente de mest nøjagtige lineariseringsfiler. Filerne hentes via følgende menuer >**Specify** + i hovedmenuen vælg >**File** > **Open** + i fildialogen angive >**Filnavn** >**Åben**.

**Kundebestemt linearisering:** Det er muligt at indtaste egne lineariseringstabeller i menuen >**Specify**.

# APPENDIX

**ATEX INSTALLATION DRAWING - 5343A**

**ATEX INSTALLATION DRAWING - 5343B**

**IECEX INSTALLATION DRAWING - 5343A**

**IECEX INSTALLATION DRAWING - 5343B**

**FM INSTALLATION DRAWING - 5343B**

**INMETRO INSTRUÇÕES DE SEGURANÇA - 5343A**

**INMETRO INSTRUÇÕES DE SEGURANÇA - 5343B**

## ATEX installationstegning



For sikker installation af 5343A skal følgende overholdes: Modulet må kun installeres af kvalificerede personer, som er bekendt med national og international lovgivning, direktiver og standarder i det land, hvor modulet skal installeres.

Produktionsår fremgår af de to første cifre i serienummeret.

ATEX-certifikat KEMA 10ATEX 0004X

Mærkning  II 3 G Ex nA [ic] IIC T4 ... T6 Gc  
II 3 G Ex ic IIC T4...T6 Gc  
II 3 D Ex ic IIIC Dc

Standarder EN 60079-0 : 2012, EN 60079-11 : 2012, EN 60079-15 : 2010

T4: $-40 \leq T_a \leq 85^{\circ}\text{C}$	<b>Klemme: 3,4,6</b>	<b>Klemme: 1,2</b>	<b>Klemme: 1,2</b>
T6: $-40 \leq T_a \leq 60^{\circ}\text{C}$	Ex nA [ic]	Ex nA	Ex ic
	Uo: 5 V	Umax $\leq 35$ VDC	Ui = 35 VDC
	Io: 4 mA		Ii = 110 mA
	Po: 20 mW		Li = 10 $\mu\text{H}$
	Lo: 900 mH		Ci = 1,0 nF
	Co: 1000 $\mu\text{F}$		

### Særlige betingelser for sikker anvendelse

Ved beskyttelsestype Ex nA skal transmitteren monteres i et hus med en tæthedegrad på mindst IP54 i overensstemmelse med EN 60529.

Ved installationer i områder med potentiel eksplosionsfare på grund af brændbart støv, skal transmitteren monteres i et hus med en tæthedegrad på mindst IP6X i overensstemmelse med EN 60529. Husets overfladetemperatur er 20 K over omgivelsestemperaturen.

Hvis omgivelsestemperaturen  $\geq 60^{\circ}\text{C}$ , skal der bruges varmebestandige kabler med specifikationer på mindst 20K over omgivelsestemperaturen.



## ATEX installationstegning



For sikker installation af 5343B skal følgende overholdes: Modulet må kun installeres af kvalificerede personer, som er bekendt med national og international lovgivning, direktiver og standarder i det land, hvor modulet skal installeres.  
Produktionsår fremgår af de to første cifre i serienummeret.

ATEX-certifikat KEMA 03ATEX 1538 X

Mærkning  II 1 G Ex ia IIC T4...T6 Ga  
II 1 D Ex ia IIIC Da  
II 1 M Ex ia I Ma

Standarder EN 60079-0 : 2012, EN 60079-11 : 2012, EN 60079-26 : 2007,

Ex-område

Zone 0, 1, 2, 20, 21, 22

T4:  $-40 \leq T_a \leq 85^\circ\text{C}$

T6:  $-40 \leq T_a \leq 60^\circ\text{C}$

**Klemme: 3,4,6**

Uo: 30 VDC

Io: 8 mA

Po: 60 mW

Lo: 35 mH

Co: 66 nF

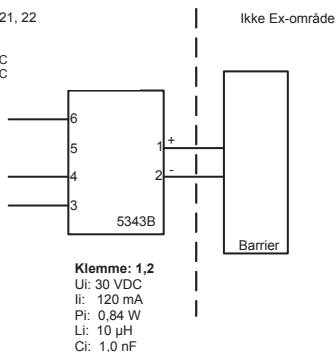

**Installationsforskrifter**

I områder med potential eksplosionsfare på grund af brændbar gas skal transmitteren installeres i et hus med en kapslingsklasse på mindst IP20 i overensstemmelse med EN60529.

Hvis transmitteren installeres i eksplosive atmosfærer, hvor kategori 1 G, 1 M eller 2 M udstyr er krævet, og hvis huset er lavet af aluminium, skal det installeres således, at der ikke er risiko for antændelse på grund af stød og friktionsgnister.

Hvis huset er lavet af ikke-metallisk materiale, skal elektrostatiske ladninger undgås.

For installation i områder med potentiel eksplosionsfare på grund af brændbart støv skal følgende overholdes:

Transmitteren skal monteres i et form B metalhus i overensstemmelse med DIN 43729. Huset skal have en tæthedsgrad på mindst IP 6X i overensstemmelse med EN 60529 og skal være egnet til den pågældende applikation samt være installeret korrekt.

Der må kun anvendes kabelforskrutninger og blindstik, som egner sig til den pågældende applikation og som installeres korrekt.

Hvis omgivelsestemperaturen  $\geq 60^{\circ}\text{C}$ , skal der bruges varmebestandige kabler med specifikationer på mindst 20K over omgivelsestemperaturen.

Husets overfladetemperatur er lig med den maksimale omgivelsestemperatur plus 20 K for støvlag med en tykkelse på op til 5 mm.

## IECEx Installation drawing



For safe installation of 5343A the following must be observed. The module shall only be installed by qualified personnel who are familiar with the national and international laws, directives and standards that apply to this area.

Year of manufacture can be taken from the first two digits in the serial number.

Certificate	IECEx DEK 13.0036X	
Marking	Ex nA [ic] IIC T6..T4 Gc	T4: $-40 \leq Ta \leq 85^{\circ}\text{C}$
	Ex ic IIC T6..T4 Gc	T6: $-40 \leq Ta \leq 60^{\circ}\text{C}$
	Ex ic IIIC Dc	
Standards	IEC 60079-0 : 2011, IEC 60079-11 : 2011, IEC 60079-15 : 2010	

Terminal	Ex nA [ic]	Ex ic
1, 2	U <sub>max</sub> = 35 V	U <sub>i</sub> : 35 V, I <sub>i</sub> :110 mA, I <sub>i</sub> :10 μH, C <sub>i</sub> :1,0 nF
3, 4, 6	U <sub>o</sub> : 5 V, I <sub>o</sub> : 4 mA, P <sub>o</sub> : 20 mW, L <sub>o</sub> : 900 mH, C <sub>o</sub> : 1000 μF	

### Installation note:

For installation in a potentially explosive gas atmosphere, the following instructions apply:

For nA installation the transmitter must be installed in an metal enclosure e.g. a form B enclosure, providing a degree of protection of at least IP54 according to IEC60529 that is suitable for the application and correctly installed or in an enclosure with type of protection Ex n or Ex e.

For intrinsically safe installation the transmitter must be installed in enclosure providing a degree of protection of at least IP20 according to IEC60529 and that is suitable for the application.

Cable entry devices and blanking elements shall fulfill the same requirements

For an ambient temperature  $\geq 60^{\circ}\text{C}$ , heat resistant cables shall be used with a rating of at least 20 K above the ambient temperature.

For installation in a potentially explosive dust atmosphere, the following instructions apply:

The surface temperature of the enclosure is equal to the ambient temperature plus 20 K, for a dust layer with a thickness up to 5 mm.

The transmitter must be mounted in a enclosure according to DIN 43729 that provides a degree of protection of at least IP6X according to IEC60529, and that is suitable for the application. Cable entry devices and blanking elements shall fulfill the same requirements.

## IECEx Installation drawing



For safe installation of 5343B the following must be observed. The module shall only be installed by qualified personnel who are familiar with the national and international laws, directives and standards that apply to this area.

Year of manufacture can be taken from the first two digits in the serial number.

Certificate	IECEx DEK 13.0036X
Marking	Ex ia IIC T4...T6 Ga Ex ia IIIC Da Ex ia I Ma
Standards	IEC 60079-0 : 2011, IEC 60079-11 : 2011, IEC 60079-26:2006

### Hazardous area

Zone 0, 1, 2, 20, 21, 22, M1

T4:  $-40 \leq T_a \leq 85^\circ\text{C}$

T5:  $-40 \leq T_a \leq 60^\circ\text{C}$

T6:  $-40 \leq T_a \leq 45^\circ\text{C}$

Non Hazardous Area

### Terminal: 3,4,6

U<sub>o</sub>: 30 VDC

I<sub>o</sub>: 8 mA

P<sub>o</sub>: 60 mW

L<sub>o</sub>: 35 mH

C<sub>o</sub>: 66 nF

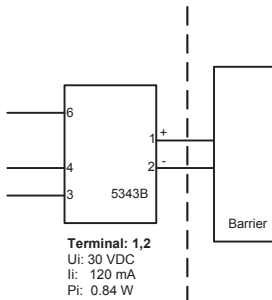

### Terminal: 1,2

U<sub>i</sub>: 30 VDC

I<sub>i</sub>: 120 mA

P<sub>i</sub>: 0.84 W

L<sub>i</sub>: 10  $\mu\text{H}$

C<sub>i</sub>: 1.0 nF

**Installation notes.**

In a potentially explosive gas atmosphere, the transmitter shall be mounted in a metal form B enclosure in order to provide a degree of protection of at least IP20 according to IEC60529. If however the environment requires a higher degree of protection, this shall be taken into account.

If the transmitter is installed in an explosive atmosphere requiring the use of equipment protection level Ga, Ma and Mb, and if the enclosure is made of aluminum, it must be installed such, that ignition sources due to impact and friction sparks are excluded.

For installation in a potentially explosive dust atmosphere, the following instructions apply:

For explosive dust atmospheres, the surface temperature of the outer enclosure is 20 K above the ambient temperature.

The transmitter shall be mounted in a metal enclosure form B according to DIN43729 that is providing a degree of protection of at least IP6X according to IEC60529, that is suitable for the application and correctly installed.

Cable entries and blanking elements shall be used that are suitable for the application and correctly installed.

For an ambient temperature  $\geq 60^{\circ}\text{C}$ , heat resistant cables shall be used with a rating of at least 20 K above the ambient temperature.

## FM Installation Drawing

### Model 5331D, 5333D and 5343B

#### Hazardous (Classified) Location

Class I, Division 1, Groups, A, B, C, D T4..T6  
Class I, Zone 0, AEx ia IIC T4..T6

Ambient temperature limits  
T4: -40 to +85 deg. Celsius  
T6: -40 to +60 deg. Celsius

Terminal 1, 2  
Vmax or Ui: 30 V  
Imax or Ii: 120 mA  
Pmax or Pi: 0.84 W  
Ci: 1 nF  
Li: 10 uH

Terminal 3, 4, 5, 6  
Vt or Uo: 9.6 V  
It or Io: 28 mA  
Pt or Po: 0.72 mW  
Ca or Co: 3.5 uF  
La or Lo: 35 mH

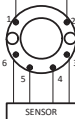

#### Non Hazardous Location

Associated Apparatus  
or Barrier  
with  
entity Parameters:

$UM \leq 250V$   
 $Voc \text{ or } Uo \leq Vmax \text{ or } Ui$   
 $Isc \text{ or } Io \leq Imax \text{ or } Ii$   
 $Po \leq Pi$   
 $Ca \text{ or } Co \geq Ci + Ccable$   
 $La \text{ or } Lo \geq Li + Lcable$

This device must not be connected  
to any associated apparatus which  
uses or generates more than 250  
VRMS

### Model 5335D, 5337D

#### Hazardous (Classified) Location

Class I, Division 1, Groups, A, B, C, D T4..T6  
Class I, Zone 0, AEx ia IIC T4..T6

Ambient temperature limits  
T4: -40 to +85 deg. Celsius  
T6: -40 to +60 deg. Celsius

Terminal 1, 2  
Vmax or Ui: 30 V  
Imax or Ii: 120 mA  
Pmax or Pi: 0.84 W  
Ci: 1 nF  
Li: 10 uH

Terminal 3, 4, 5, 6  
Vt or Uo: 9.6 V  
It or Io: 28 mA  
Pt or Po: 0.72 mW  
Ca or Co: 3.5 uF  
La or Lo: 35 mH

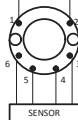

#### Non Hazardous Location

Associated Apparatus  
or Barrier  
with  
entity Parameters:

$UM \leq 250V$   
 $Voc \text{ or } Uo \leq Vmax \text{ or } Ui$   
 $Isc \text{ or } Io \leq Imax \text{ or } Ii$   
 $Po \leq Pi$   
 $Ca \text{ or } Co \geq Ci + Ccable$   
 $La \text{ or } Lo \geq Li + Lcable$

This device must not be connected  
to any associated apparatus which  
uses or generates more than 250  
VRMS

### The entity concept

The Transmitter must be installed according to National Electrical Code (ANSI-NFPA 70) and shall be installed with the enclosure, mounting, and spacing segregation requirement of the ultimate application.

Equipment that is FM-approved for intrinsic safety may be connected to barriers based on the ENTITY CONCEPT. This concept permits interconnection of approved transmitters, meters and other devices in combinations which have not been specifically examined by FM, provided that the agency's criteria are met. The combination is then intrinsically safe, if the entity concept is acceptable to the authority having jurisdiction over the installation.

The entity concept criteria are as follows:

The intrinsically safe devices, other than barriers, must not be a source of power.

The maximum voltage  $U_i(V_{MAX})$  and current  $I_i(I_{MAX})$ , and maximum power  $P_i(P_{MAX})$ , which the device can receive and remain intrinsically safe, must be equal to or greater than the voltage ( $U_o$  or  $V_{OC}$  or  $V_i$ ) and current ( $I_o$  or  $I_{SC}$  or  $I_i$ ) and the power  $P_o$  which can be delivered by the barrier.

The sum of the maximum unprotected capacitance ( $C_i$ ) for each intrinsically device and the interconnecting wiring must be less than the capacitance ( $C_a$ ) which can be safely connected to the barrier.

The sum of the maximum unprotected inductance ( $L_i$ ) for each intrinsically device and the interconnecting wiring must be less than the inductance ( $L_a$ ) which can be safely connected to the barrier.

The entity parameters  $U_o, V_{OC}$  or  $V_i$  and  $I_o, I_{SC}$  or  $I_i$ , and  $C_a$  and  $L_a$  for barriers are provided by the barrier manufacturer.

### NI Field Circuit Parameters

### Model 5331D, 5333D, 5335D, 5337D and 5343B

#### Hazardous (Classified) Location

Class I, Division 2, Groups, A, B, C, D T4..T6  
Class I, Zone 2, IIC T4..T6

Ambient temperature limits  
T4: -40 to +85 deg. Celsius  
T6: -40 to +60 deg. Celsius

Terminal 1, 2  
 $V_{max}$  : 35 V  
 $C_i$ : 1.0 nF  
 $L_i$ : 10 uH

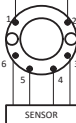

#### Non Hazardous Location

Associated Apparatus  
or Barrier

This device must not be connected  
to any associated apparatus which  
uses or generates more than 250  
VRMS

## Desenho de Instalação INMETRO



Para instalação segura do 5333A ou 5343A o seguinte deve ser observado. O modo deve apenas ser instalado por pessoas qualificadas que são familiarizadas com as leis nacionais e internacionais, diretrizes e padrões que se aplicam a esta área.

Ano de fabricação pode ser pego dos dois primeiros dígitos do número de série.

Certificado DEKRA 16.0014 X

Marcas

Ex nA [ic] IIC T6..T4 Gc

Ex ic IIC T6..T4 Gc

Ex ic IIIC Dc

T4:  $-40 \leq T_a \leq 85^{\circ}\text{C}$

T6:  $-40 \leq T_a \leq 60^{\circ}\text{C}$

Normas ABNT NBR IEC 60079-0 : 2013; ABNT NBR IEC 60079-11 : 2013  
ABNT NBR IEC60079-15 : 2012

Terminals	Ex nA [ic]	Ex ic
1,2	$U \leq 35\text{V}$	Ui : 35V, li:110mA, li:10 $\mu\text{H}$ , Ci:1,0nF
3,4,6	Uo: 5V, Io: 4mA, Po: 20mW, Lo: 900mH, Co: 1000 $\mu\text{F}$	

### Notas para instalação

Para a instalação em uma atmosfera de gás potencialmente explosivo, se aplicam as instruções a seguir:

Para a instalação nA o transmissor deve ser instalado em um invólucro de metal, por exemplo, gabinete em forma B que forneça um grau de proteção de pelo menos IP54 de acordo com IEC60529 ou em um invólucro com tipo de proteção Ex n ou Ex e.

Para a instalação Ex ic o transmissor deve ser instalado em um invólucro proporcionando um grau de proteção de IP20, pelo menos, de acordo com a norma ABNT NBR IEC 60529. E o invólucro deve ser adequado para a aplicação e corretamente instalado.

Dispositivos de entrada de cabos e elementos de supressão devem cumprir os mesmos requisitos.

Para temperatura ambiente  $\geq 60^{\circ}\text{C}$ , fios de resistência ao calor devem ser usados com uma faixa de pelo menos 20K acima da temperatura ambiente.

Para a instalação em uma atmosfera de poeira potencialmente explosiva, se aplicam as instruções a seguir:

O transmissor deve ser montado em invólucro de metal forma B de acordo com DIN43729 que está fornecendo um grau de proteção de pelo menos IP6X de acordo com ABNT NBR IEC60529.

O invólucro deve ser adequado para aplicação e instalado corretamente.

As entradas dos cabos e os elementos de obturação que podem ser utilizados são adequados para a aplicação e corretamente instalados.

A temperatura da superfície do invólucro é igual à temperatura ambiente mais 20 K, para uma camada de pó, com uma espessura até 5 mm.



## Desenho de Instalação InNMETRO



Para instalação segura do 5333D ou 5343B o seguinte deve ser observado. O modo deve apenas ser instalado por pessoas qualificadas que são familiarizadas com as leis nacionais e internacionais, diretrizes e padrões que se aplicam a esta área.

Ano de fabricação pode ser pego dos dois primeiros dígitos do número de série.

Certificado	DEKRA 16.0014 X
Marcas	Ex ia IIC T6...T4 Ga Ex ia IIIC Da
Normas	ABNT NBR IEC 60079-0 : 2013; ABNT NBR IEC 60079-11 : 2013

### Áreas Risco

Zona 0, 1, 2, 20, 21, 22, M1

T4:  $-40 \leq T_a \leq 85^\circ\text{C}$

T5:  $-40 \leq T_a \leq 60^\circ\text{C}$

T6:  $-40 \leq T_a \leq 45^\circ\text{C}$

Areas de não Risco

### Terminais: 3,4,5,6

Uo: 30 VDC  
Io: 8 mA  
Po: 60 mW  
Lo: 35 mH  
Co: 66 nF

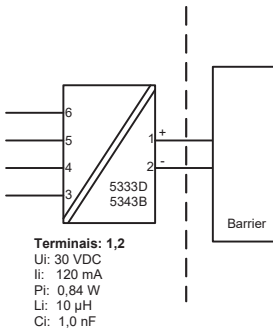

**Notas de Instalação.**

Em uma atmosfera de gás potencialmente explosiva, o transmissor deve ser montado em um enclosure a fim de garantir um grau de proteção de no mínimo IP20 de acordo com ABNT NBR IEC60529. Se contudo o ambiente requer um nível de proteção maior, isso deve ser levado em conta

Se o transmissor é instalado em uma atmosfera explosiva exigindo o uso de equipamento de proteção de nível Ga e se o invólucro é feito de alumínio, ele deve ser instalado de modo que, mesmo em caso de avaria rara, fontes de ignição devido a impacto e fricção, faíscas são eliminadas; Se o enclosure é feito de materiais não metálicos, cargas eletroestáticas devem ser evitadas.

Se o enclosure é feito de materiais não metálicos, cargas eletroestáticas devem ser evitadas.

Para instalação em atmosfera de poeira potencialmente explosiva, as instruções a seguir:

O transmissor deve ser montado em invólucro de metal forma B de acordo com DIN43729 que está fornecendo um grau de proteção de pelo menos IP6X de acordo com ABNT NBR IEC60529. O invólucro deve ser adequado para aplicação e instalado corretamente.

As entradas dos cabos e os elementos de obturação que podem ser utilizados são adequados para a aplicação e corretamente instalados.

Para temperatura ambiente  $\geq 60^{\circ}\text{C}$ , fios de resistência ao calor devem ser usados com uma faixa de pelo menos 20K acima da temperatura ambiente.

A temperatura da superfície do invólucro é igual à temperatura ambiente mais de 20 K, por uma camada de pó, com uma espessura até 5 mm.



**Displays** Programmable displays with a wide selection of inputs and outputs for display of temperature, volume and weight, etc. Feature linearization, scaling, and difference measurement functions for programming via PReset software.



**Ex interfaces** Interfaces for analog and digital signals as well as HART signals between sensors / I/P converters / frequency signals and control systems in Ex zone 0, 1 & 2 and for some devices in zone 20, 21 & 22.



**Isolation** Galvanic isolators for analog and digital signals as well as HART signals. A wide product range with both loop-powered and universal isolators featuring linearization, inversion, and scaling of output signals.



**Temperature** A wide selection of transmitters for DIN form B mounting and DIN rail devices with analog and digital bus communication ranging from application-specific to universal transmitters.



**Universal** PC or front programmable devices with universal options for input, output and supply. This range offers a number of advanced features such as process calibration, linearization and auto-diagnosis.





[www.preelectronics.fr](http://www.preelectronics.fr)  
[sales-fr@preelectronics.com](mailto:sales-fr@preelectronics.com)



[www.preelectronics.de](http://www.preelectronics.de)  
[sales-de@preelectronics.com](mailto:sales-de@preelectronics.com)



[www.preelectronics.es](http://www.preelectronics.es)  
[sales-es@preelectronics.com](mailto:sales-es@preelectronics.com)



[www.preelectronics.it](http://www.preelectronics.it)  
[sales-it@preelectronics.com](mailto:sales-it@preelectronics.com)



[www.preelectronics.se](http://www.preelectronics.se)  
[sales-se@preelectronics.com](mailto:sales-se@preelectronics.com)



[www.preelectronics.com](http://www.preelectronics.com)  
[sales-uk@preelectronics.com](mailto:sales-uk@preelectronics.com)



[www.preelectronics.com](http://www.preelectronics.com)  
[sales-us@preelectronics.com](mailto:sales-us@preelectronics.com)



[www.preelectronics.cn](http://www.preelectronics.cn)  
[sales-cn@preelectronics.com](mailto:sales-cn@preelectronics.com)



## Head office

---

Denmark  
PR electronics A/S  
Lerbakken 10  
DK-8410 Rønne

[www.preelectronics.com](http://www.preelectronics.com)  
[sales-dk@preelectronics.com](mailto:sales-dk@preelectronics.com)  
tel. +45 86 37 26 77  
fax +45 86 37 30 85