

PERFORMANCE  
MADE  
SMARTER

产品手册

5437

二线制 HART 7 温度变送器

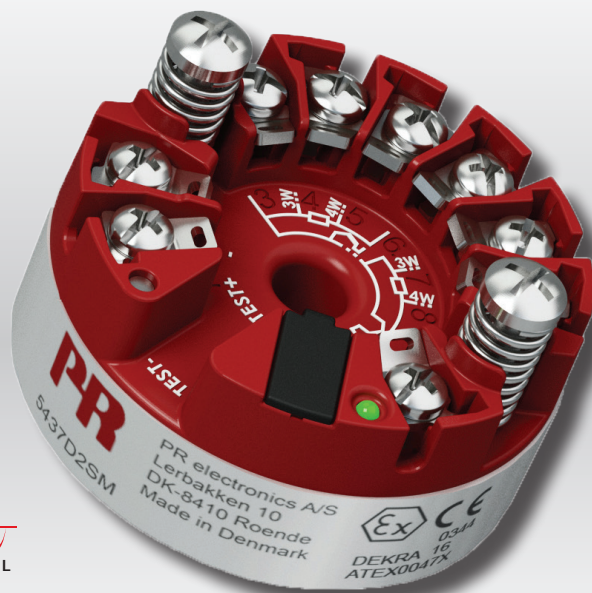

**HART**  
COMMUNICATION PROTOCOL



温度

安全栅

通讯接口

多功能

隔离器

数显表

No. 5437V104-CN

Product version: 01.00.00-01.99.99

**PR**  
electronics

# 6 大特色产品

## 满足您的一切需求

### 单品出色·组合无敌

凭借创新型专利技术·信号调节更加简单·智能·产品组合由六大产品类组成·具备多种模拟量和数字量模块·涵盖上千种工业自动化应用·所有产品都符合甚至高于行业的最高标准·这可确保产品即便在最恶劣的环境条件下仍能可靠运行·5 年产品保修期·让您使用更安心·



Temperature

温度变送器和温度传感器系列产品·提供从温度测量点到系统控制一站式信号解决方案·从而在最大程度上保证信号的完整性·仅需一套点对点解决方案·您就可以在任何环境中将工业过程中的温度信号转换为模拟量信号·总线信号或数字通讯信号·该方案具备响应时间短·自动校准·传感器故障检测·低漂移和卓越 EMC 性能等诸多优点·



I.S. Interface

我们采用最严格的安全标准来检验产品·以期提供最安全的信号·秉承创新精神·我们已经在 SIL 2 全面评估本质安全型接口方面取得了开创性成就·其既高效又经济·效果卓著·成效斐然·模拟量和数字量本质安全栅种类齐全·同时提供多种输入输出·这使得 PR 标准成为一项易于实施的现场检验标准·在大型项目安装过程中·新背板方案大大简化安装和布线·且能与标准 DCS 系统无缝集成·



Communication

我们提供经济实惠·使用方便·面向未来的通讯接口·以便您能够访问所安装的 PR 产品·所有接口均可拆卸·并带有屏幕和按钮·可以显示过程值/诊断值和对参数进行配置·产品特定功能包括通过 Modbus 和蓝牙进行通讯·以及使用我们的便携式设备主管 (PPS) 应用程序进行远程访问·可用于 iOS 和 Android·



Multifunction

单品为多功能系列产品·可涵盖大量现场应用·可轻而易举按照您的现场标准进行配置·此种单品可适用多种应用方式·既节省安装和培训时间·又大大简化库存备件管理·该设备专为长期信号精度高·功耗低·抗电噪声优异·编程简单而设计·



Isolation

基于微处理器技术研发的 6 mm 隔离器·小巧精致·响应迅速·品质一流·以极低的总拥有成本为专用应用提供卓越性能和抗电磁干扰·可水平或垂直安装·装置间无需间隙·



Display

数显表系列以其灵活性和稳定性著称·该设备系列几乎满足过程信号读数显示的所有需求·并具有通用的输入和供电能力·无论哪种行业·无论环境条件何其苛刻·该设备均能实时测量过程值并提供用户友好型界面和值得信赖的继电器信号·

# 二线制 HART 7 温度变送器 5437

## 目录

应用.....	4
技术特点.....	4
安装调试.....	4
应用.....	4
订购.....	5
附件.....	5
标签示例.....	5
机械规格.....	14
LED 功能.....	15
跳线.....	15
测试引脚.....	16
HART 命令.....	16
高级功能.....	17
动态变量映射.....	18
设备变量概述.....	18
软件写保护.....	19
跳线写保护.....	19
更改 HART 协议版本.....	19
SIL 功能.....	21
接线方式.....	22
框图.....	23
设置参数.....	23
变送器多点模式连接.....	25
EMC 规格 – 抗干扰性.....	26
EMC 规格 – 辐射性能.....	27
ATEX 安装图.....	28
IECEx Installation Drawing.....	33
CSA Installation Drawing.....	38
FM Installation Drawing.....	41
Instalação INMETRO.....	46
NEPSI Installation Drawing.....	51
Appendix A: Diagnostics overview.....	53
文档更新记录.....	56

# 二线制 HART 7 温度变送器

## 5437

- RTD·TC·电位器·线性电阻和双极性 mV 输入
- 单路或双路传感器输入·具备传感器冗余和漂移检测功能
- 适宜工作的环境温度范围大:-50 到 +85°C
- 总精度达 0.014%
- 2.5 kVAC 电气隔离
- 符合 IEC 61508:2010 的全面评估·适用于 SIL 2 / 3 应用

### 应用

- 测量各类 TC 和 RTD 温度输入类型。
- 转换大跨度线性电阻和电位器输入。
- 转换双极性 mV 信号为 4...20 mA。
- 整合入资产管理计划。
- 需要高精度和/或传感器冗余和漂移检测的关键应用。

### 技术特点

- 真正双输入变送器·高密度 7 端子设计可接受最广泛的双输入组合。
- 传感器冗余 - 在主传感器故障的情况下·输出自动切换到备份传感器·保证过程正常运行。
- 传感器漂移检测 - 当传感器差异超过用户定义限制时进行报警·增强维护优化。
- 过程数据的动态变量映射·例如双输入功能的均值·差值·以及最小 / 最大值追踪。
- 全量程输入范围和环境条件下的·突破性的数字和模拟信号精度。
- 广泛的传感器匹配·包括 Callendar Van Dusen 和自定义线性化表。
- 可设定的输入限值配合运行时间统计·确保最大的过程可追溯性和传感器超范围保护。
- 符合 IEC 61508:2010 标准最高至 SIL 3 的全面评估·以及符合 IEC 61236-3-1 标准的增强 EMC 功能安全测试。
- 符合 NAMUR NE21·NE43·NE44·NE89·NE95 和 NE107 标准诊断信息。

### 安装调试

- 标准 DIN B 型传感器头部安装。
- 通过标准 HART 通讯接口或 PR 5909 回路通讯器进行参数配置。
- 5437A 可以安装于 zone 2 和 zone 22 / Class I, Division 1, Groups A, B, C, D 区域。
- 5437B 可以安装于 zone 0, 1, 2 和 zone 20, 21, 22 以及 M1。
- 5437D 可以安装于 zone 0, 1, 2 和 zone 20, 21, 22 以及 M1 / Class I, Division 1, Groups A, B, C, D 区域。

### 应用

#### 双输入

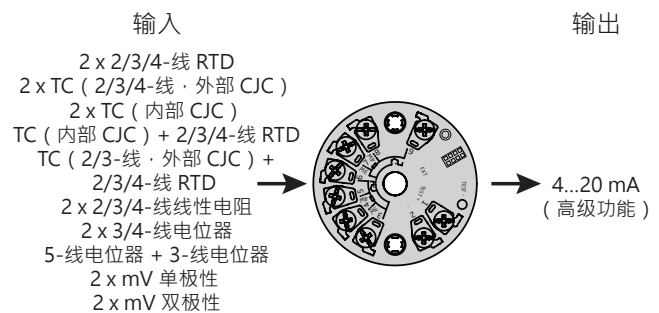

#### 单输入

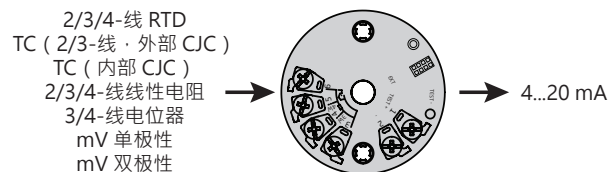

订购









型号	版本	输入	SIL 认证	船舶认证
5437	一般用途 / Zone 2 / DIV. 2 : A	单输入 ( 4 端子 ) : 1	SIL : S	是 :
	Zone 0, 1, 2, 20, 21, 22, M1 : B ( 仅限ATEX )	双输入 ( 7 端子 ) : 2	Ikke SIL : -	否 M : -
	Zone 0, 1, 2, 20, 21, 22, M1 / DIV. 1, DIV. 2 : D			

附件



5909	= USB 接口回路通讯器和 Preset 软件
276USB	= USB 接口 HART 调制解调器

标签示例









5437A2SM

 <b>5437A2SM</b>	PR electronics A/S Lerbakken 10 DK-8410 Roende Made in Denmark SN:123456789	    	DEKRA 18 ATEX0135X IECEX DEK 16.0029X FM16US0287X FM16CA0146X CSA 70066266 GYJ 18.1054X	  RU C-DK. 16.98. B.00192 DEKRA 16.0008X	Segurança Ver:01.04.03 EU RO:MRA0000023 SIL:PREI 16031107 Install.:SN5437 Tag:	5437S101
--	---	---	---	--	---	----------

5437B2SM

 <b>5437B2SM</b>	PR electronics A/S Lerbakken 10 DK-8410 Roende Made in Denmark SN:123456789	  0344	II 1G Ex ia IIC T6...T4 Ga II 2(1) G Ex ib [ia Ga] IIC T6...T4 Gb II 1 D Ex ia IIIC Da I M1 Ex ia I Ma See installation drawing 5437QA01	Ui: 30V Ii: 120 mA Pi: see install Ci: 1nF Li: 0	Ver:01.04.03 EU RO:MRA0000023 SIL:PREI 16031107 Tag:	5437BS101
--	---	--	--	--	---	-----------

5437D2SM

 <b>5437D2SM</b>	PR electronics A/S Lerbakken 10 DK-8410 Roende Made in Denmark SN:123456789	    	DEKRA 16 ATEX0047X IECEX DEK 16.0029X FM16US0287X FM16CA0146X CSA 70066266 GYJ 18.1054X	  RU C-DK. 16.98. B.00192 DEKRA 16.0008X	Segurança Ver:01.04.03 EU RO:MRA0000023 SIL:PREI 16031107 Install.:SN5437 Tag:	5437S101
--	---	---	---	--	---	----------

## 技术参数

### 环境条件:

工作环境温度范围:

标准	-50°C 至 +85°C
SIL	-40°C 至 +80°C
存储温度	-50°C 至 +85°C
标定温度	23...25°C
相对湿度	< 99% RH (无冷凝)
防护等级 (外壳/端子)	IP68 / IP00

### 机械规格:

结构尺寸	Ø 44 x 20.2 mm
中心孔直径	Ø 6.35 mm / ¼ in
重量	50 g
导线规格	1 x 1.5 mm <sup>2</sup> 绞线
螺丝端子力矩	0.4 Nm
抗振规格	IEC 60068-2-6
2...25 Hz	±1.6 mm
25...100 Hz	±4 g

### 常用规格:

电源电压 · DC:

5437A	7.5*...48** VDC
5437B 和 5437D	7.5*...30** VDC
5437, EU-RO	8.3...33.6 VDC ±10%
使用测试端子时额外所需电源电压	0.8 V
内部功耗 (最大)	≤ 850 mW
最小负载电阻 (供电 > 37 V 时)	(电源电压 - 37) / 23 mA

\* 注意: 最小电源电压必须在 5437 的端子处测量, 即必须考虑所有外部压降。

\*\*注意: 请确保使用合适的电源或安装过压保护装置来保护设备免受过电压损坏。

隔离电压 · 测试/工作:

5437A	2.5 kVAC / 55 VAC
5437B 和 5437D	2.5 kVAC / 42 VAC
极性反接保护	所有输入和输入
写保护	跳线或软件
预热时间	< 5 分钟
启动时间	< 2.75 s
参数设置	Loop Link & HART
信噪比	> 60 dB
长期稳定性	优于 ±0.05% 所设量程 / 年 ±0.18% 所设量程 / 5年
响应时间	70 ms
可调阻尼	0...60 s
信号动态范围 · 输入	24 bit
信号动态范围 · 输出	18 bit
电源电压变化对精度的影响	< 0.005% 所设量程 / VDC

输入精度:

基本精度		
输入类型	基本精度	温度系数*
Pt10	$\leq \pm 0.8^{\circ}\text{C}$	$\leq \pm 0.020^{\circ}\text{C} / ^{\circ}\text{C}$
Pt20	$\leq \pm 0.4^{\circ}\text{C}$	$\leq \pm 0.010^{\circ}\text{C} / ^{\circ}\text{C}$
Pt50	$\leq \pm 0.16^{\circ}\text{C}$	$\leq \pm 0.004^{\circ}\text{C} / ^{\circ}\text{C}$
Pt100	$\leq \pm 0.04^{\circ}\text{C}$	$\leq \pm 0.002^{\circ}\text{C} / ^{\circ}\text{C}$
Pt200	$\leq \pm 0.08^{\circ}\text{C}$	$\leq \pm 0.002^{\circ}\text{C} / ^{\circ}\text{C}$
Pt500	$T_{\text{max.}} \leq 180^{\circ}\text{C}: \leq \pm 0.08^{\circ}\text{C}$ $T_{\text{max.}} > 180^{\circ}\text{C}: \leq \pm 0.16^{\circ}\text{C}$	$\leq \pm 0.002^{\circ}\text{C} / ^{\circ}\text{C}$
Pt1000	$\leq \pm 0.08^{\circ}\text{C}$	$\leq \pm 0.002^{\circ}\text{C} / ^{\circ}\text{C}$
Pt2000	$T_{\text{max.}} \leq 300^{\circ}\text{C}: \leq \pm 0.08^{\circ}\text{C}$ $T_{\text{max.}} > 300^{\circ}\text{C}: \leq \pm 0.4^{\circ}\text{C}$	$\leq \pm 0.002^{\circ}\text{C} / ^{\circ}\text{C}$
Pt10000	$\leq \pm 0.16^{\circ}\text{C}$	$\leq \pm 0.002^{\circ}\text{C} / ^{\circ}\text{C}$
Pt x	邻近点的最高公差	邻近点的最高系数
Ni10	$\leq \pm 1.6^{\circ}\text{C}$	$\leq \pm 0.020^{\circ}\text{C} / ^{\circ}\text{C}$
Ni20	$\leq \pm 0.8^{\circ}\text{C}$	$\leq \pm 0.010^{\circ}\text{C} / ^{\circ}\text{C}$
Ni50	$\leq \pm 0.32^{\circ}\text{C}$	$\leq \pm 0.004^{\circ}\text{C} / ^{\circ}\text{C}$
Ni100	$\leq \pm 0.16^{\circ}\text{C}$	$\leq \pm 0.002^{\circ}\text{C} / ^{\circ}\text{C}$
Ni120	$\leq \pm 0.16^{\circ}\text{C}$	$\leq \pm 0.002^{\circ}\text{C} / ^{\circ}\text{C}$
Ni200	$\leq \pm 0.16^{\circ}\text{C}$	$\leq \pm 0.002^{\circ}\text{C} / ^{\circ}\text{C}$
Ni500	$\leq \pm 0.16^{\circ}\text{C}$	$\leq \pm 0.002^{\circ}\text{C} / ^{\circ}\text{C}$
Ni1000	$\leq \pm 0.16^{\circ}\text{C}$	$\leq \pm 0.002^{\circ}\text{C} / ^{\circ}\text{C}$
Ni2000	$\leq \pm 0.16^{\circ}\text{C}$	$\leq \pm 0.002^{\circ}\text{C} / ^{\circ}\text{C}$
Ni10000	$\leq \pm 0.32^{\circ}\text{C}$	$\leq \pm 0.002^{\circ}\text{C} / ^{\circ}\text{C}$
Ni x	邻近点的最高公差	邻近点的最高系数
Cu5	$\leq \pm 1.6^{\circ}\text{C}$	$\leq \pm 0.040^{\circ}\text{C} / ^{\circ}\text{C}$
Cu10	$\leq \pm 0.8^{\circ}\text{C}$	$\leq \pm 0.020^{\circ}\text{C} / ^{\circ}\text{C}$
Cu20	$\leq \pm 0.4^{\circ}\text{C}$	$\leq \pm 0.010^{\circ}\text{C} / ^{\circ}\text{C}$
Cu50	$\leq \pm 0.16^{\circ}\text{C}$	$\leq \pm 0.004^{\circ}\text{C} / ^{\circ}\text{C}$
Cu100	$\leq \pm 0.08^{\circ}\text{C}$	$\leq \pm 0.002^{\circ}\text{C} / ^{\circ}\text{C}$
Cu200	$\leq \pm 0.08^{\circ}\text{C}$	$\leq \pm 0.002^{\circ}\text{C} / ^{\circ}\text{C}$
Cu500	$\leq \pm 0.16^{\circ}\text{C}$	$\leq \pm 0.002^{\circ}\text{C} / ^{\circ}\text{C}$
Cu1000	$\leq \pm 0.08^{\circ}\text{C}$	$\leq \pm 0.002^{\circ}\text{C} / ^{\circ}\text{C}$
Cu x	邻近点的最高公差	邻近点的最高系数
线性电阻 : 0...400 $\Omega$	$\leq \pm 40 \text{ m}\Omega$	$\leq \pm 2 \text{ m}\Omega / ^{\circ}\text{C}$
线性电阻 : 0...100 k $\Omega$	$\leq \pm 4 \Omega$	$\leq \pm 0.2 \Omega / ^{\circ}\text{C}$
电位器 : 0...100%	$< 0.05\%$	$< \pm 0.005\%$

\* 输入温度系数为列出的值或输入范围的 0.002% · 以较大者为准。

基本精度		
输入类型	基本精度	温度系数*
mV: -20...100 mV	$\leq \pm 5 \mu\text{V}$	$\leq \pm 0.2 \mu\text{V} / ^\circ\text{C}$
mV: -100...1700 mV	$\leq \pm 0.1\text{mV}$	$\leq \pm 36 \mu\text{V} / ^\circ\text{C}$
mV: $\pm 800$ mV	$\leq \pm 0.1\text{mV}$	$\leq \pm 32 \mu\text{V} / ^\circ\text{C}$
TC E	$\leq \pm 0.2^\circ\text{C}$	$\leq \pm 0.025^\circ\text{C} / ^\circ\text{C}$
TC J	$\leq \pm 0.25^\circ\text{C}$	$\leq \pm 0.025^\circ\text{C} / ^\circ\text{C}$
TJ K	$\leq \pm 0.25^\circ\text{C}$	$\leq \pm 0.025^\circ\text{C} / ^\circ\text{C}$
TC L	$\leq \pm 0.35^\circ\text{C}$	$\leq \pm 0.025^\circ\text{C} / ^\circ\text{C}$
TC N	$\leq \pm 0.4^\circ\text{C}$	$\leq \pm 0.025^\circ\text{C} / ^\circ\text{C}$
TC T	$\leq \pm 0.25^\circ\text{C}$	$\leq \pm 0.025^\circ\text{C} / ^\circ\text{C}$
TC U	$< 0^\circ\text{C}: \leq \pm 0.8^\circ\text{C}$ $\geq 0^\circ\text{C}: \leq \pm 0.4^\circ\text{C}$	$\leq \pm 0.025^\circ\text{C} / ^\circ\text{C}$
TC Lr	$\leq \pm 0.2^\circ\text{C}$	$\leq \pm 0.1^\circ\text{C} / ^\circ\text{C}$
TC R	$< 200^\circ\text{C}: \leq \pm 0.5^\circ\text{C}$ $\geq 200^\circ\text{C}: \leq \pm 1.0^\circ\text{C}$	$\leq \pm 0.1^\circ\text{C} / ^\circ\text{C}$
TC S	$< 200^\circ\text{C}: \leq \pm 0.5^\circ\text{C}$ $\geq 200^\circ\text{C}: \leq \pm 1.0^\circ\text{C}$	$\leq \pm 0.1^\circ\text{C} / ^\circ\text{C}$
TC W3	$\leq \pm 0.6^\circ\text{C}$	$\leq \pm 0.1^\circ\text{C} / ^\circ\text{C}$
TC W5	$\leq \pm 0.4^\circ\text{C}$	$\leq \pm 0.1^\circ\text{C} / ^\circ\text{C}$
TC 型号: B <sup>1</sup>	$\leq \pm 1^\circ\text{C}$	$\leq \pm 0.1^\circ\text{C} / ^\circ\text{C}$
TC 型号: B <sup>2</sup>	$\leq \pm 3^\circ\text{C}$	$\leq \pm 0.1^\circ\text{C} / ^\circ\text{C}$
TC 型号: B <sup>3</sup>	$\leq \pm 8^\circ\text{C}$	$\leq \pm 0.8^\circ\text{C} / ^\circ\text{C}$
TC 型号: B <sup>4</sup>	未指定	未指定
CJC ( 内部 )	$< \pm 0.5^\circ\text{C}$	包含在基本精度内
CJC ( 外部 )	$\leq \pm 0.08^\circ\text{C}$	$\leq \pm 0.002^\circ\text{C} / ^\circ\text{C}$

\* 输入温度系数为列出的值或输入范围的 0.002% · 以较大者为准。

TC B<sup>1</sup> 精度规格适用范围 . . . . . > 400°C  
 TC B<sup>2</sup> 精度规格适用范围 . . . . . > 160°C < 400°C  
 TC B<sup>3</sup> 精度规格适用范围 . . . . . > 85°C < 160°C  
 TC B<sup>4</sup> 精度规格适用范围 . . . . . < 85°C

输出精度:

基本精度		
输出类型	基本精度	温度系数
均值测量	输入 1 和 2 的 平均精度	输入 1 和 2 的 平均温度系数
差值测量	输入 1 和 2 的 精度和	输入 1 和 2 的 温度系数和
模拟量输出	$\leq \pm 1.6\mu\text{A}$ ( 满量程的 0.01% )	$\leq \pm 0.48\mu\text{A} / \text{K}$ ( $\leq \pm 0.003\%$ 满量程 / K )



精度计算举例：

示例：Pt100 传感器，配置为 -200°C 至 + 850°C：

Pt100基本精度 = 0.04°C

输出模拟量精度 = 0.0016 mA

$$\text{总体精度 (mA)} = \frac{\text{基本精度}}{\text{设定量程输入}} \times 16.0 \text{ mA} + \text{输出模拟量精度}$$

$$\text{总体精度 (mA)} = \frac{0.04^\circ\text{C}}{850^\circ\text{C} - (-200^\circ\text{C})} \times 16.0 \text{ mA} + 0.0016 \text{ mA} = \underline{0.0022 \text{ mA}}$$

$$\text{总体精度 (\%)} = \frac{\text{总体精度 (mA)}}{16.0 \text{ mA}} \times 100\%$$

$$\text{总体精度 (\%)} = \frac{0.0022 \text{ mA}}{16.0 \text{ mA}} \times 100\% = \underline{0.01381\%}$$

示例：型号 K TC，内部 CJC，配置从 0°C 到 400°C：

型号 K TC基本精度 = 0.25°C

输出模拟量精度 = 0.0016 mA

$$\text{总体精度 (mA)} = \frac{\text{基本精度} + \text{内部 CJC}}{\text{设定量程输入}} \times 16.0 \text{ mA} + \text{输出模拟量精度}$$

$$\text{总体精度 (mA)} = \frac{0.25^\circ\text{C} + 0.5^\circ\text{C}}{400^\circ\text{C}} \times 16.0 \text{ mA} + 0.0016 \text{ mA} = \underline{0.0316 \text{ mA}}$$

$$\text{总体精度 (\%)} = \frac{\text{总体精度 (mA)}}{16.0 \text{ mA}} \times 100\%$$

$$\text{总体精度 (\%)} = \frac{0.0316 \text{ mA}}{16.0 \text{ mA}} \times 100\% = \underline{0.1975\%}$$

示例：型号 K TC，外部 CJC Pt1000，配置从 0°C 到 400°C：

型号 K TC基本精度 = 0.25°C

输出模拟量精度 = 0.0016 mA

$$\text{总体精度 (mA)} = \frac{\text{基本精度} + \text{外部 CJC}}{\text{设定量程输入}} \times 16.0 \text{ mA} + \text{输出模拟量精度}$$

$$\text{总体精度 (mA)} = \frac{0.25^\circ\text{C} + 0.08^\circ\text{C}}{400^\circ\text{C}} \times 16.0 \text{ mA} + 0.0016 \text{ mA} = \underline{0.0148 \text{ mA}}$$

$$\text{总体精度 (\%)} = \frac{\text{总体精度 (mA)}}{16.0 \text{ mA}} \times 100\%$$

$$\text{总体精度 (\%)} = \frac{0.0148 \text{ mA}}{16.0 \text{ mA}} \times 100\% = \underline{0.0925\%}$$

示例精度计算基于工厂校准环境温度，并且不考虑其他潜在的不准确来源，例如电源影响，环境温度波动等。

EMC – 电磁兼容 . . . . .	< ±0.1% 所设量程
扩展的 EMC 电磁兼容 :	
NAMUR NE 21, A criterion, burst. . . . .	< ±1% 所设量程

输入规格:

RTD 输入类型:

RTD 类型	标准	最小值	最大值	$\alpha$	最小量程
Pt10...10.000	IEC 60751	-200°C	+850°C	0.003851	10°C
	JIS C 1604-8	-200°C	+649 °C	0.003916	10°C
	GOST 6651-2009	-200°C	+850°C	0.003910	10°C
	Callendar Van Dusen	-200°C	+850°C	-----	10°C
Ni10...10.000	DIN 43760-1987	-60°C	+250°C	0.006180	10°C
	GOST 6651-2009 / OIML R84:2003	-60°C	+180°C	0.006170	10°C
Cu5...1000	Edison Copper Winding No. 15	-200°C	+260°C	0.004270	100°C
	GOST 6651-2009 / OIML R84:2003	-180°C	+200°C	0.004280	100°C
	GOST 6651-94	-50°C	+200°C	0.004260	100°C

连接类型 . . . . .	2-, 3- 和 4-线
电缆电阻 (单根导线; 最大) . . . . .	50 $\Omega$
传感器电流 . . . . .	< 0.15 mA
传感器电缆电阻的影响 (3- / 4-线) . . . . .	< 0.002 $\Omega / \Omega$
传感器电缆 · 线-线电容 . . . . .	最大 30 nF (Pt1000 & Pt10000 IEC 和 JIS + Ni1000 & NI10000) 最大 50 nF (以上其它)
传感器故障检测 · 可设置 . . . . .	无 · 短路 · 断线 · 短路或断线

 注意: 无论传感器故障检测如何配置, 如果配置的传感器类型的下限低于传感器短路检测常数限值, 则将禁用传感器短路故障检测。

传感器短路检测限值 . . . . .	15 $\Omega$
传感器故障检测时间 (RTD 元件) . . . . .	$\leq 70$ ms
传感器故障检测时间 (第 3 线和第 4 线) . . . . .	$\leq 2000$ ms

TC 输入类型:

型号	最低温度	最高温度	最小量程	标准
B	0 (85)°C	+1820°C	100°C	IEC 60584-1
E	-200°C	+1000°C	50°C	IEC 60584-1
J	-100°C	+1200°C	50°C	IEC 60584-1
K	-180°C	+1372°C	50°C	IEC 60584-1
L	-200°C	+900°C	50°C	DIN 43710
Lr	-200°C	+800°C	50°C	GOST 3044-84
N	-180°C	+1300°C	50°C	IEC 60584-1
R	-50°C	+1760°C	100°C	IEC 60584-1
S	-50°C	+1760°C	100°C	IEC 60584-1
T	-200°C	+400°C	50°C	IEC 60584-1
U	-200°C	+600°C	50°C	DIN 43710
W3	0°C	+2300°C	100°C	ASTM E988-96
W5	0°C	+2300°C	100°C	ASTM E988-96

冷端补偿 (CJC) :

固定补偿 · 通过 Pt100 或 Ni100 传感器实现内部或外部补偿

内部 CJC 温度范围	-50°C 至 +100°C
外部 CJC 连接	2, 3 或 4-线 (4 线仅适用于双输入)
外部 CJC 电缆电阻 (单根导线; 3-线和 4-线连接)	50 Ω
CJC 电缆电阻的影响 (3-线和 4-线连接)	< 0.002 Ω / Ω
外部 CJC 传感器电流	< 0.15 mA
外部 CJC 温度范围	-50°C 至 +135°C
CJC 传感器电缆 · 线-线电容	最大 50 nF
最大总电缆电阻	最大 10 kΩ
传感器电缆 · 线-线电容	最大 50 nF
传感器故障检测 · 可设置	无 · 短路 · 断线 · 短路或断线

	传感器短路检测仅适用于 CJC 传感器。
---	----------------------

传感器故障检测时间 (TC 元件)	≤ 70 ms
传感器故障检测时间 · 外部 CJC (第 3 线和第 4 线)	≤ 2000 ms

**线性电阻输入:**

输入范围	0 Ω...100 kΩ
最小量程	25 Ω
连接类型	2-, 3- 或 4-线
电缆电阻 (单根导线; 最大)	50 Ω
传感器电流	< 0.15 mA
传感器电缆电阻的影响 (3- / 4-线)	< 0.002 Ω / Ω
传感器电缆 · 线-线电容	最大 30 nF (线性电阻 > 400 Ω) 最大 50 nF (线性电阻 ≤ 400 Ω)
传感器故障检测 · 可设置	无 · 断线

**电位器输入:**

电位器	10 Ω...100 kΩ
输入范围	0...100 %
最小量程	10%
连接类型	3-, 4- 或 5-线 (5 线仅适用于双输入设备)
电缆电阻 (单根导线; 最大)	50 Ω
传感器电流	< 0.15 mA
传感器电缆电阻的影响 (4- / 5-线)	< 0.002 Ω / Ω
传感器电缆 · 线-线电容	最大 30 nF (电位器 > 400 Ω) 最大 50 nF (电位器 ≤ 400 Ω)
传感器故障检测 · 可设置	无 · 短路 · 断线 · 短路或断线

	注意: 无论传感器故障检测如何配置, 如果配置的电位器阻值类型低于传感器短路检测常数限值, 则将禁用传感器短路故障检测。
---	--

传感器短路检测限值	15 Ω
传感器故障检测时间 (电位器检测臂)	≤ 70 ms (无传感器短路检测)
传感器故障检测时间 · 元件	≤ 2000 ms
传感器故障检测时间 (第 4 线和第 5 线)	≤ 2000 mss

**mV 输入:**

测量范围	-800...+800 mV (双极性) -100 至 1700 mV
最小量程	2.5 mV
输入电阻	10 MΩ
传感器电缆 · 线-线电容	最大 30 nF (输入范围: -100...1700 mV) 最大 50 nF (输入范围: -20...100 mV)
传感器故障检测 · 可设置	无 · 断线
传感器故障检测时间	≤ 70 ms

**输出规格和 HART:**

正常范围 · 可设定	3.8...20.5 / 20.5...3.8 mA
扩展范围 (输出限制) · 可设定	3.5...23 / 23...3.5 mA
更新时间	10 ms
负载 (@ 电流输出)	$\leq (V_{\text{supply}} - 7.5) / 0.023 [\Omega]$
负载稳定性	< 0.01% 所设量程 / 100 $\Omega$

所设量程 = 当前选择的量程范围

输出负载:

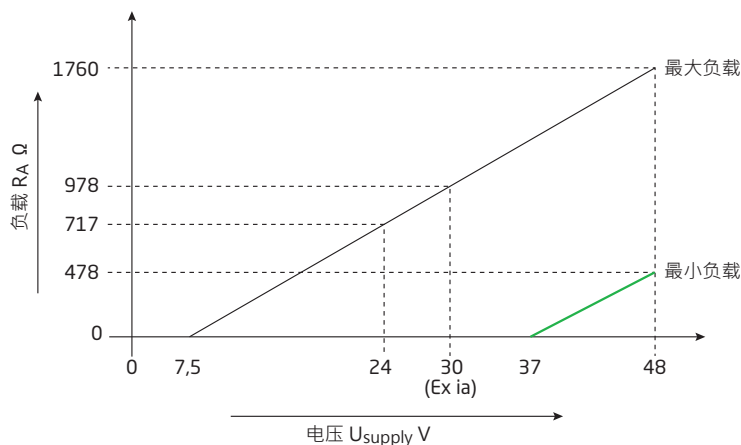

传感器故障指示 · 可设定	3.5...23 mA
(在选择 TC 和 mV 输入时不检测传感器短路报警)	
NAMUR NE43 Upscale	> 21 mA
NAMUR NE43 Downscale	< 3.6 mA
HART 协议修订版本	HART 7 和 HART 5

**可设定输入 / 输出限制:**

故障电流	启用 / 禁用
设置故障电流	3.5 mA...23 mA

可设定的传感器输入和电流输出限制可用于提高系统安全性和完整性。

### 输入：

当输入信号超过可设定的下限或上限时，设备将输出用户定义的故障电流。设置输入限制可确保任何超出范围的测量值都可以通过变送器输出进行唯一识别和标记，从而改进资产和材料保护，例如可以缓解反应过程的热失控。

### 例如：

Pt100 输入范围 100°C 到 400°C

输入限制设置为上限 = +650°C, 下限 = -150°C

故障电流设置为 3.5 mA

输出限制设置为上限 = 20.5 mA, 下限 = 3.8 mA

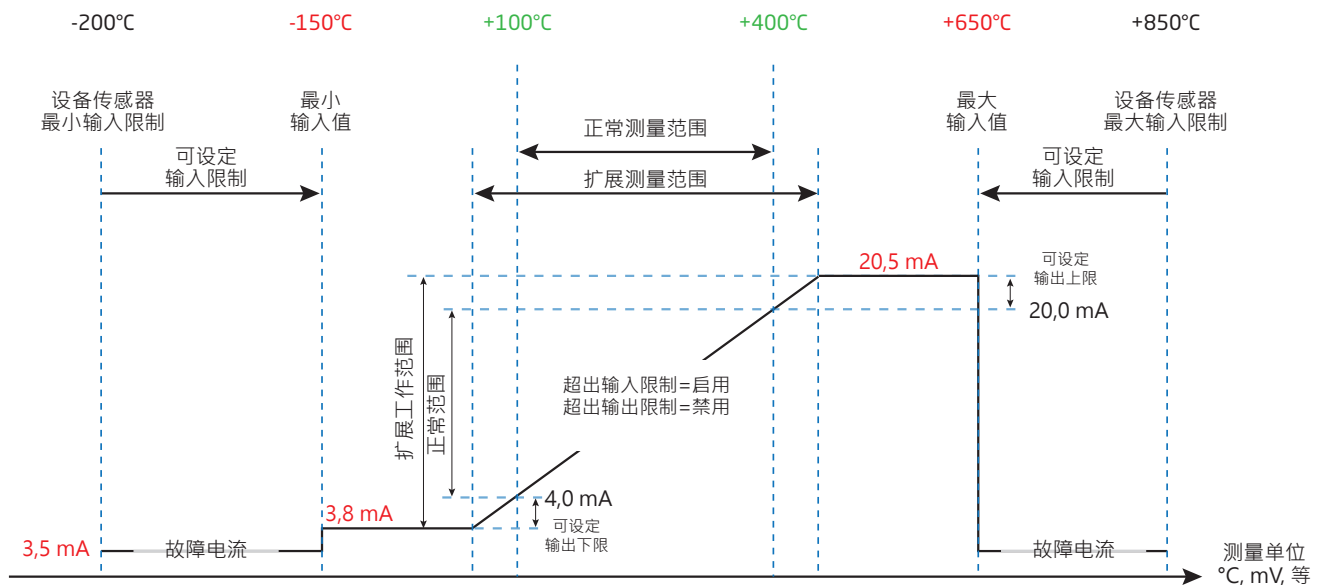

### 输出：

当电流输出超过可设定的上限或下限时，设备将输出用户定义的故障电流。

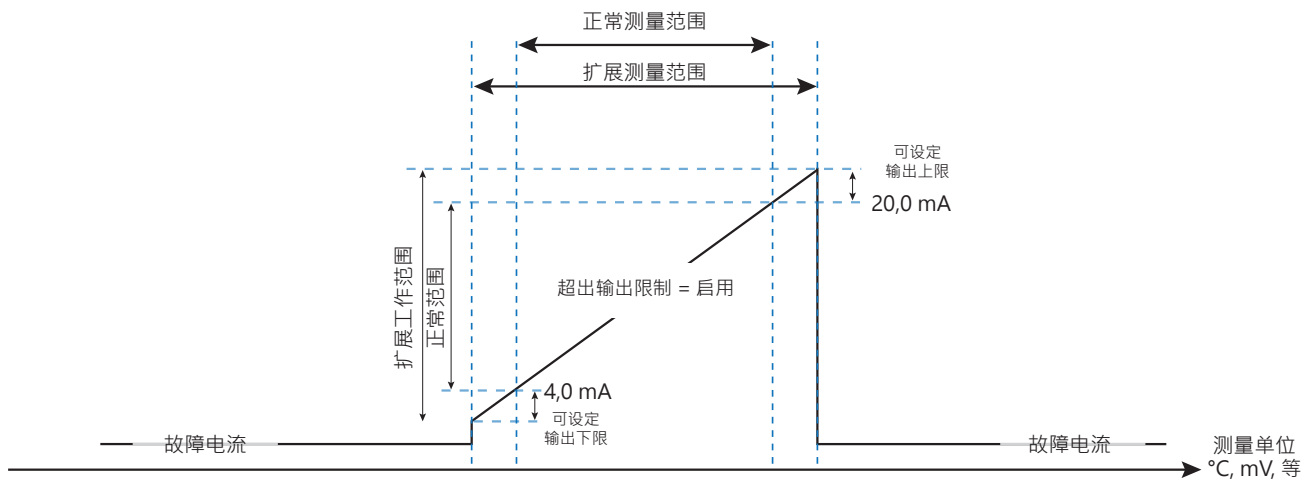

**符合标准:**

EMC	2014/30/EU
ATEX	2014/34/EU
RoHS	2011/65/EU
EAC	TR-CU 020/2011
EAC Ex	TR-CU 012/2011

**认证:**

EU RO Mutual Recognition Type Approval	MRA0000023
--	------------

**Ex / I.S. 认证:**

5437A:	
ATEX	DEKRA 18ATEX0135 X
5437B:	
ATEX	DEKRA 16ATEX0047 X
5437D:	
ATEX	DEKRA 16ATEX0047 X
5437A 和 5437D:	
IECEX	IECEX DEK. 16.0029 X
c FM us	FM16CA0146X / FM16US0287X
c CSA us	70066266
INMETRO	DEKRA 16.0008X
NEPSI	GYJ18.1054X
EAC Ex	RU C-DK.ПБ.98.B.00192

**功能安全:**

SIL2 认证 & 符合 IEC 61508 : 2010 的全面评估

SFF > 93% - type B component

SIL3 适用于冗余结构 ( HFT = 0; 1oo2 )

FMEDA 报告下载 - [www.prelectronics.com](http://www.prelectronics.com)

**NAMUR:**

NAMUR NE95报道 . . . . . 请联系我们

**机械规格**

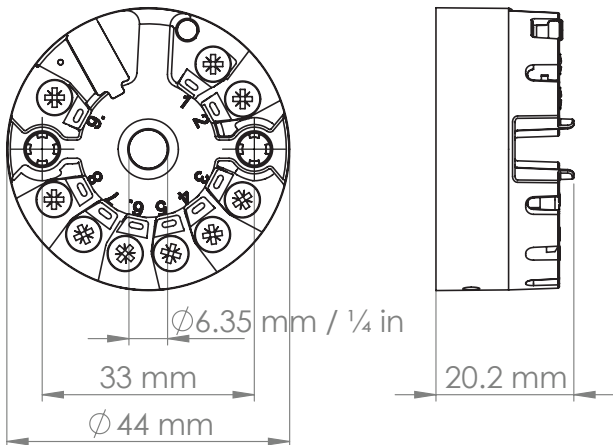

## LED 功能

产品 LED 根据 NAMUR NE44 和 NE107 指示故障状态。

状态	绿色 / 红色 LED
设备正常	常亮
无电源	OFF
指示与设备无关的故障·例如断线·传感器短路·超输入或输出限制等	闪烁 
设备故障	常亮

有关详细的设备诊断行为和 NE107 信息·请参阅第 53 页的附录 A。

## 跳线

设备拥有两个内部跳线 - 一个跳线用于启用写保护·另一个跳线用于选择安全状态下的输出电流到 21 mA 以上·如 NAMUR NE43 中规定的那样。

如果未插入跳线·则安全状态下的输出电流将低于 3.6 mA·如 NAMUR NE43 中规定的那样。

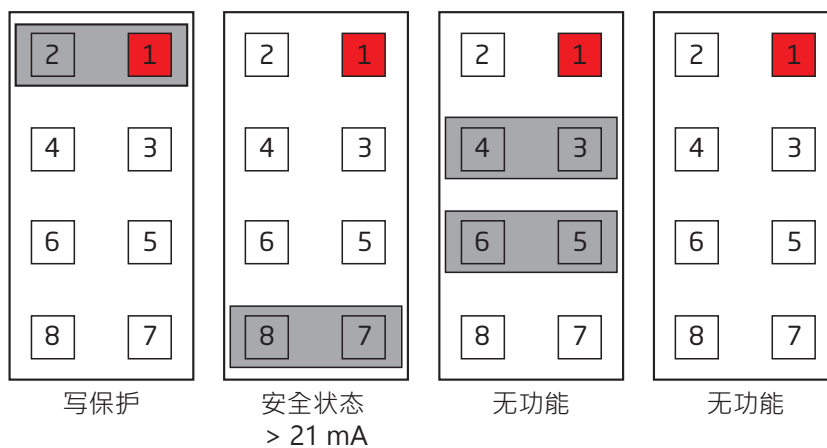

跳线针号 1 在图中以红色标记。

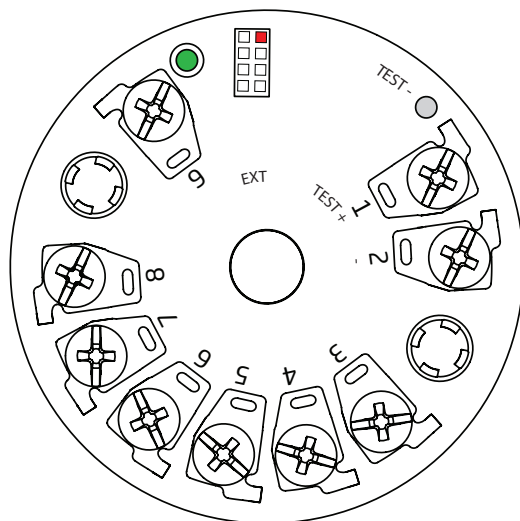

## 测试引脚

测试引脚可以直接测量回路电流，并同时保持工作回路不中断。使用测试引脚时，变送器必须连接电源。

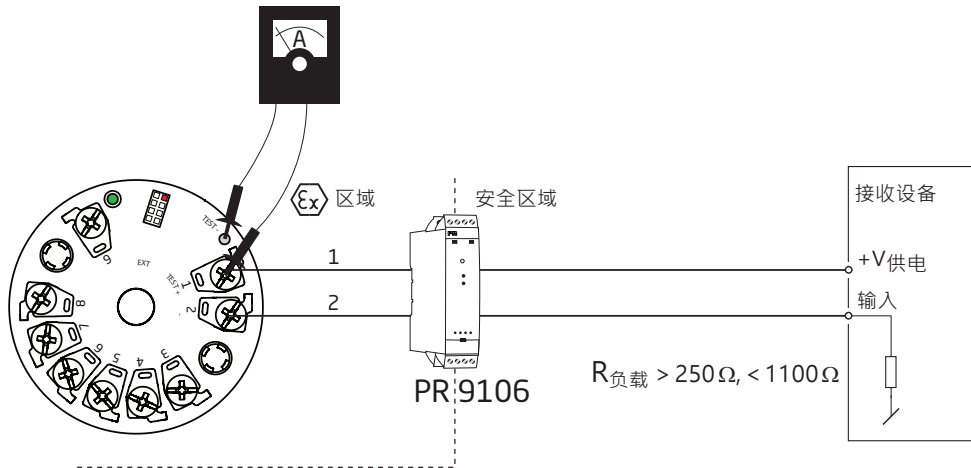

### 警告！

对于危险区域安装，只能使用认证的测试设备。

## HART 命令

有关 5437 HART 命令的定义和更多信息，请参阅现场设备规范。



## 高级功能

功能	描述									
差值	模拟量输出信号与输入 1 和输入 2 之间的差值成比例。 模拟量输出 = 输入 1 - 输入 2 或输入 2 - 输入 1 或   输入 2 - 输入 1									
均值	模拟量输出信号与输入 1 和输入 2 测量的平均值成比例。 模拟量输出 = 0.5 * (输入 1 + 输入 2)									
最大值	模拟量输出与具有最高值的输入成比例。 如果 (输入 1 > 输入 2) 则 模拟量输出 = 输入 1 否则 模拟量输出 = 输入 2									
最小值	模拟量输出与具有最低值的输入成比例。 如果 (输入 1 < 输入 2) 则 模拟量输出 = 输入 1 否则 模拟量输出 = 输入 2									
传感器漂移	如果输入 1 和输入 2 之间的测量值差值超过预定义的极限值, 则会指示传感器漂移故障。 如果   输入 1 - 输入 2   > 传感器漂移限制 则 指示传感器漂移故障									
冗余 (热备份)	只要未检测到故障并且输入未超出用户定义限值, 模拟量输出与输入 1 成比例。如果检测到输入 1 故障或传感器 1 的值超出用户定义限值, 则模拟量输出就自动切换到与输入 2 成比例, 并生成一条警告指示。 如果 (输入 1 无传感器故障 以及 输入 1 无内部超限报警) 则 模拟量输出 = 输入 1 否则如果 (输入 2 无传感器故障 和 输入 2 无内部超限报警) 则 模拟量输出 = 输入 2									
自定义线性化 - 多项式类型	支持最多 5 段多项式线性化, 每段支持高达 4 阶多项式。									
自定义线性化 - Callendar Van Dusen	支持直接输入 CVD 常数。									
自定义线性化 - 线性化表	支持多达 60 个输入 / 输出对应值的线性化表格。									
定制线性化 - 二次样条线性化	支持多达 40 个输出值的二次样条线性化。									
运行时间统计 - 变送器电路	统计记录变送器运行期间其内部温度和相联时间, 数据通过 9 个固定温度区间记录。 <table border="1" style="margin-left: 20px;"> <tr><td>&lt; -50°C</td></tr> <tr><td>-50...-30°C</td></tr> <tr><td>-30...-10°C</td></tr> <tr><td>-10...+10°C</td></tr> <tr><td>+10...+30°C</td></tr> <tr><td>+30...+50°C</td></tr> <tr><td>+50...+70°C</td></tr> <tr><td>+70...+85°C</td></tr> <tr><td>&gt;85°C</td></tr> </table>	< -50°C	-50...-30°C	-30...-10°C	-10...+10°C	+10...+30°C	+30...+50°C	+50...+70°C	+70...+85°C	>85°C
< -50°C										
-50...-30°C										
-30...-10°C										
-10...+10°C										
+10...+30°C										
+30...+50°C										
+50...+70°C										
+70...+85°C										
>85°C										
运行时间统计 - 输入	记录设备运行过程中的输入测量值, 数据以时间统计的方式分类记录在 9 个固定输入子区间内。每种输入类型有单独定义的子范围。									
从指针 - 变送器电路	记录变送器完整生命周期内最小 / 最大内部温度值。									
从指针 - 输入	记录最小 / 最大输入测量值。当测量配置更改时, 此值会被重置。									

# 动态变量映射

支持四个动态变量 PV·SV·TV 和 QV。

使用 HART 命令，可以任意组合分配给任何设备变量 (DV 0 - 15)。映射到 PV 的设备变量控制着回路电流。

设备变量	
DV0	输入 1 (温度·电压·电阻...)
DV1	输入 2 (温度·电压·电阻...)
DV2	CJC 1·输入 1 CJC 温度·只有输入 1 是 TC 时有效
DV3	CJC 2·输入 2 CJC 温度·只有输入 2 是 TC 时有效
DV4	均值 (输入 1 和 输入 2)
DV5	差值 (输入 1 - 输入 2)
DV6	差值 (输入 2 - 输入 1)
DV7	差值绝对值 (输入 1 - 输入 2)
DV8	最小值 (输入 1·输入 2)
DV9	最大值 (输入 1·输入 2)
DV10	输入 1 带输入 2 作为备份
DV11	输入 2 带输入 1 作为备份
DV12	均值带输入 1 或 2 作为备份
DV13	最小值带输入 1 或 2 作为备份
DV14	最大值带输入 1 或 2 作为备份
DV15	电路温度

# 设备变量概述

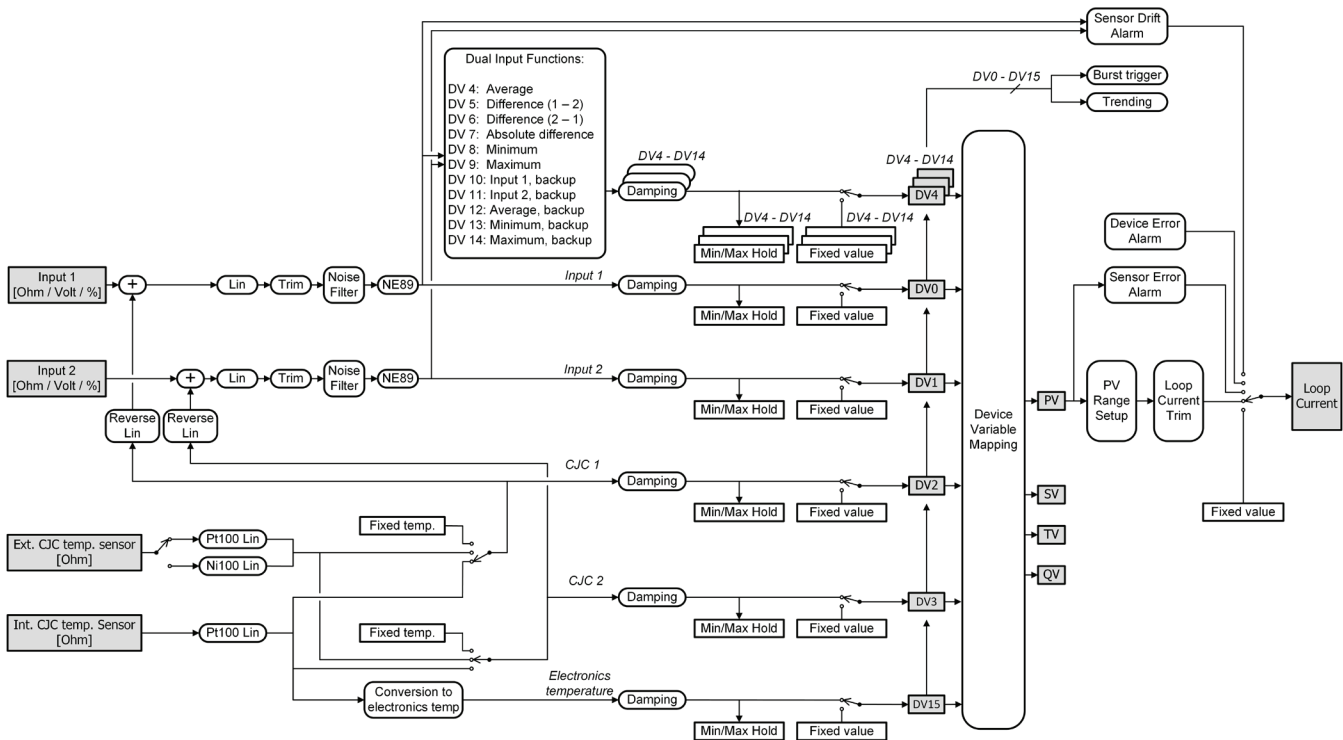

## 软件写保护

设备离开工厂时的默认密码为“\*\*\*\*\*”；该值用户可以更改。

如果忘记了当初当前密码，请联系 PR electronics 支持人员 - [www.prelectronics.com/cn/contact](http://www.prelectronics.com/cn/contact)。  
更改密码时，只能使用可以输入和显示在任何终端的 Latin-1 字符。

当启用写保护时，无论“写保护”硬件跳线位置如何，都不会接受“写入”命令。

## 跳线写保护

如果硬件跳线设置在“写保护”位置，则无论是否被软件禁用，都不会接受“写入”命令。

## 更改 HART 协议版本

可以使用 PReset 软件和 PR 5909 回路通讯器或 HART 接口来更改本机的 HART 协议版本。  
还可以使用其他 HART 配置工具，如手持式 HART 终端。

使用 HART 手持终端将 5437 从 HART 7 更改为 HART 5 的步骤，反之亦然：

将 5437 从 HART 7 更改为 HART 5：

1. 进入设备菜单 (或按 home 键) 后，显示在线菜单
2. 选择设备设置并按向右箭头键 (或直接按数字 7 键)
3. 选择诊断 / 服务，然后按向右箭头键 (或直接按数字 3 键)
4. 选择写保护，然后按向右箭头键 (或直接按数字 6 键)
5. 选择更改为 HART 5，然后按向右箭头键 (或直接按数字 3 键)
6. 当显示屏显示“您确定要将协议更改为 HART 5？”时，按 OK
7. 输入正确的活动密码，默认为“\*\*\*\*\*” (八颗星)，然后按 OK
8. 当显示器显示“设备现在处于 HART 5 模式”时，按 OK，然后退出，进入离线模式，并重新扫描新设备。
9. 设备现在将显示为 5437 (HART5) 设备，选择它，并再次进入在线菜单

注意！更改为 HART 5 后，配置将重置为出厂默认值。

在线菜单中的快捷键顺序为：7·3·6·3·OK·OK·OK·Exit。

要将设备更改回 HART 7，请按照与上述相同的步骤进行操作，但必须在步骤 5 中选择“更换为 HART 7”。

但改回 HART 7 时，配置保持不变。

使用 PReset 软件和 5909 回路通讯器或 HART 通讯接口端将 5437 从 HART 7 更改为 HART 5 的步骤·反之亦然：

## 从 HART 7 切换到 HART 5

选择 5437 产品·然后单击“HART”选项卡。

单击“设备密码 / 写保护 / 协议...”·在弹出的窗口中选择“更改 HART 5 协议”·然后按 OK 确认。

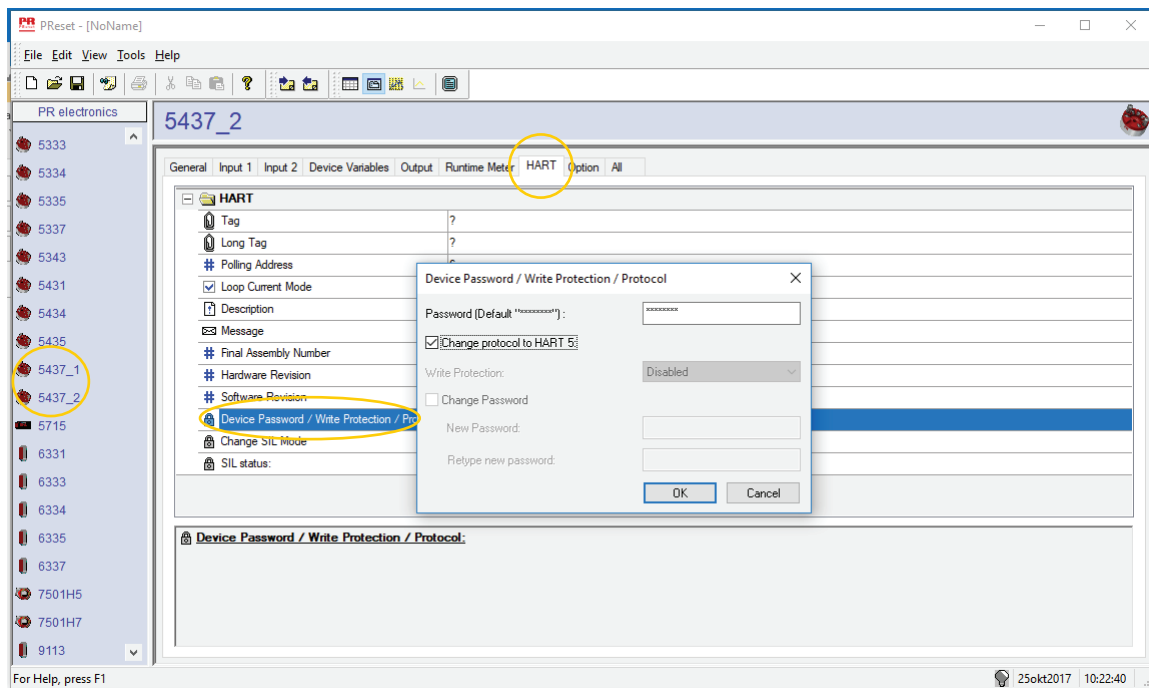

然后将出现以下消息：

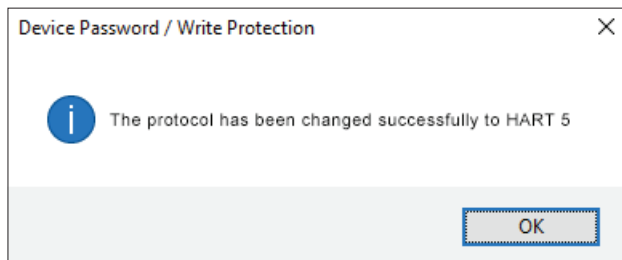

注意！更改为 HART 5 后·配置将重置为出厂默认值。

## 从 HART 5 切换到 HART 7

选择 5437 产品，然后单击“HART”选项卡。

单击“设备密码 / 写保护 / 协议...”，在弹出的窗口中选择“更改协议到 HART 7”，然后按 OK 确认。

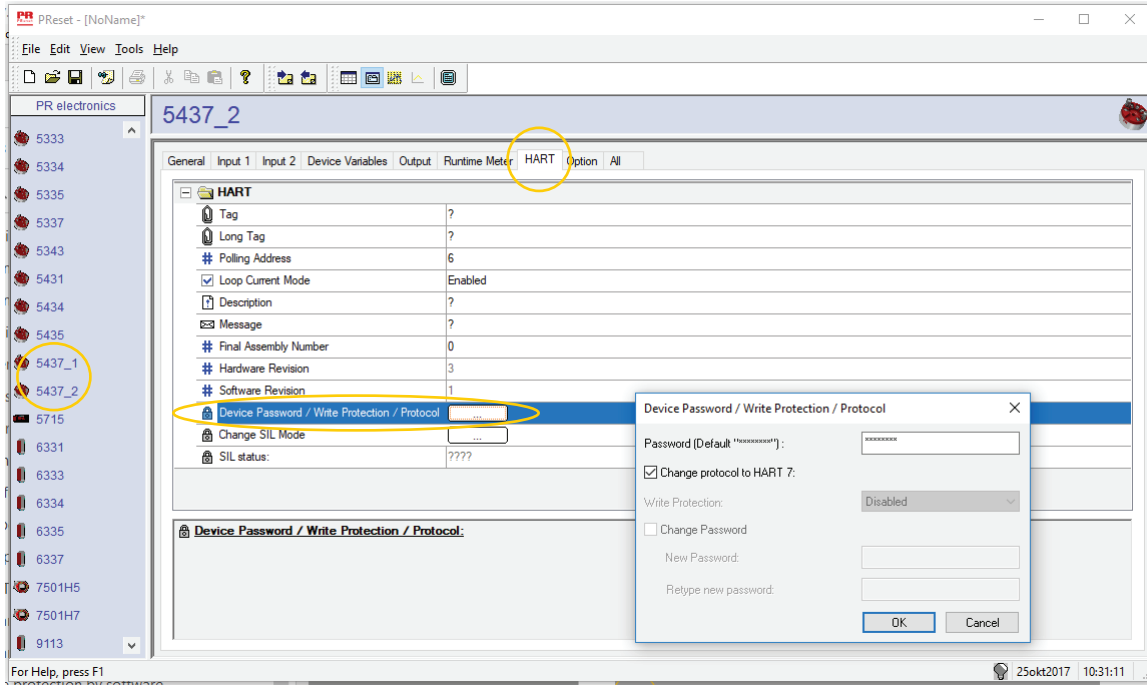

然后将出现以下消息：

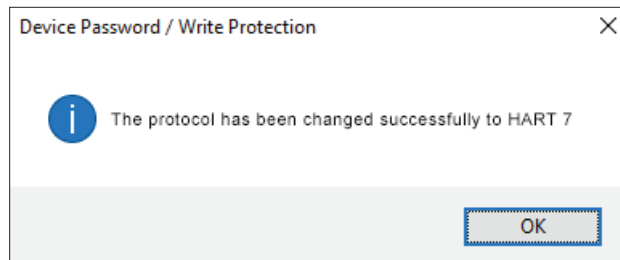

## SIL 功能

有关如何在 5437 上启用 SIL 模式的说明和进一步信息，请参阅“安全手册”。

# 接线方式

## 单输入

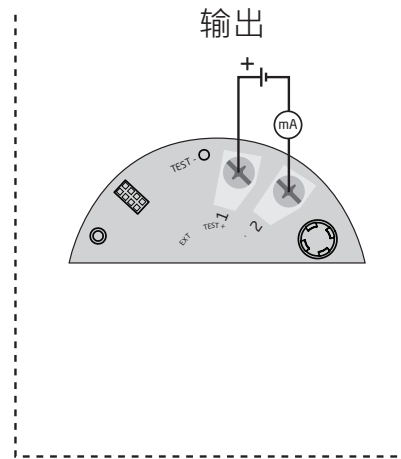
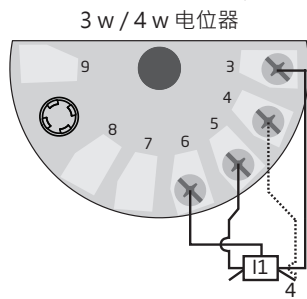
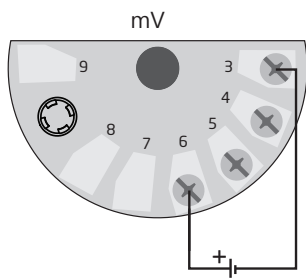
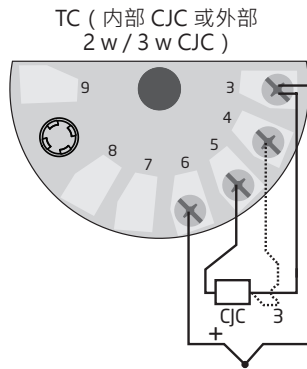
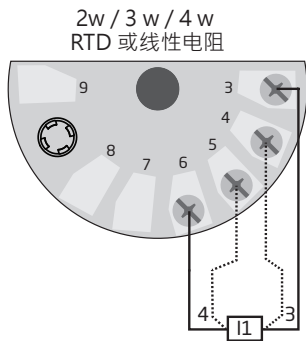

## 双输入

输入 1: 2w / 3w / 4w RTD 或线性电阻  
输入 2: 2w / 3w / 4w RTD 或线性电阻

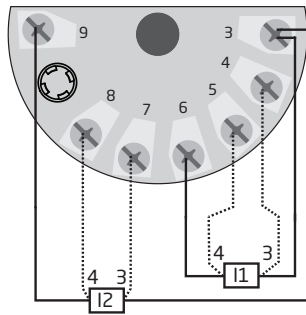

输入 1: TC (内部 CJC 或外部  
2w / 3w / 4w CJC)  
输入 2: TC (内部 CJC 或外部  
2w / 3w / 4w CJC)

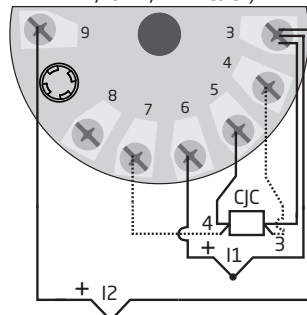

输入 1: mV  
输入 2: mV

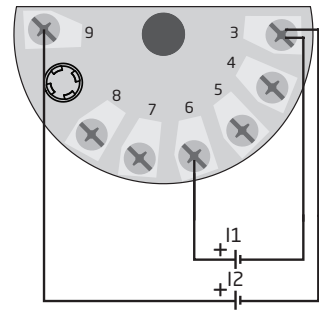

输入 1: TC (内部 CJC 或外部 2w / 3w CJC)  
输入 2: 2w / 3w / 4w RTD

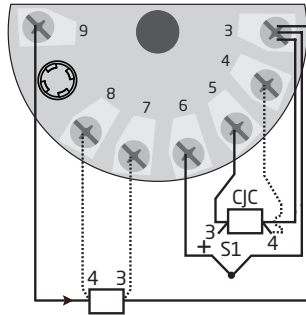

输入 1: 3w / 4w 电位器  
输入 2: 3w / 4w 电位器

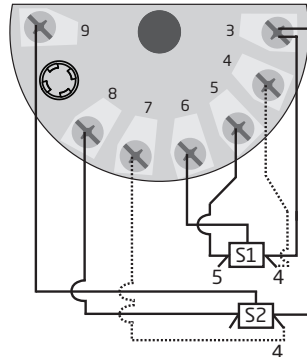

输入 1: 5w 电位器  
输入 2: 3w 电位器

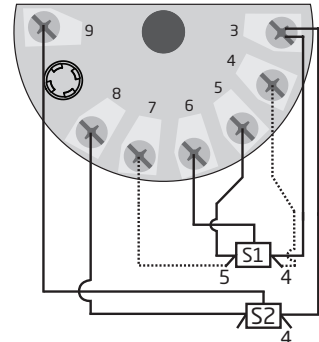

## 框图

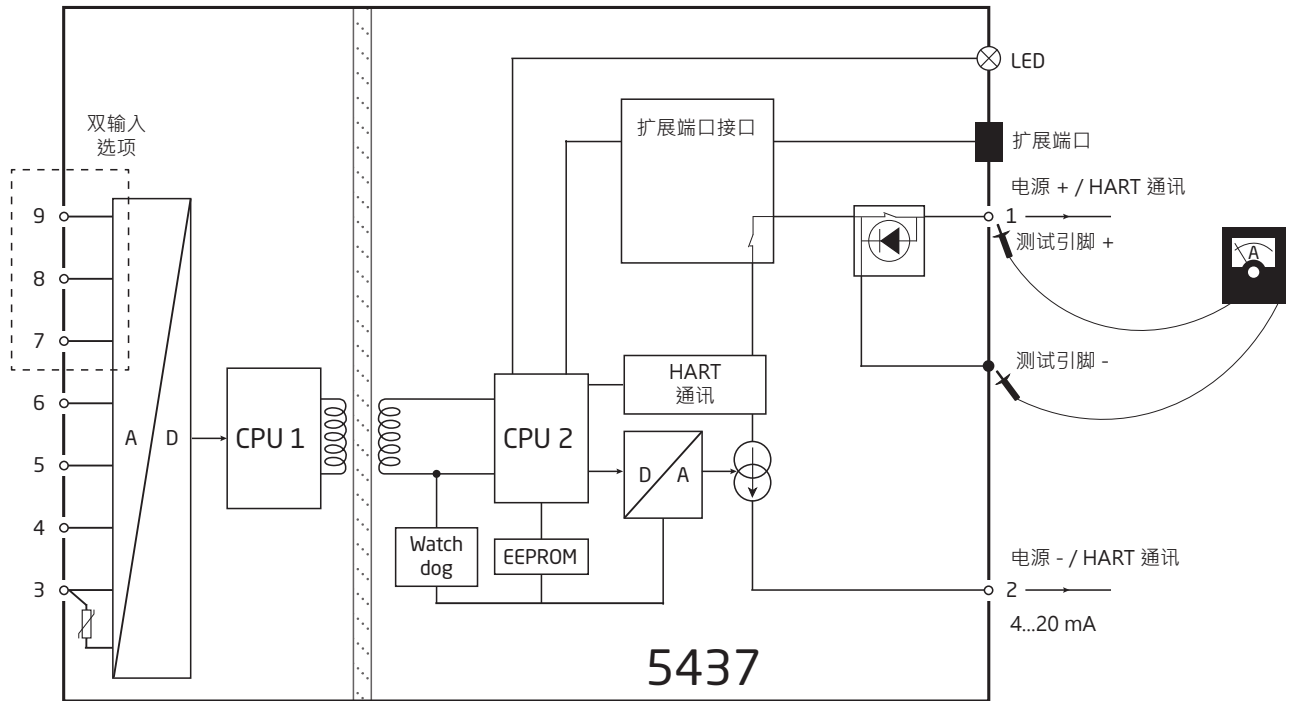

## 设置参数

5437 可以通过以下 4 种方式进行配置：

1. 通过 PR electronics A/S 的回路通讯器和 PReset 电脑配置软件。
2. 通过 HART 调制解调器和 PReset 电脑配置软件。
3. 通过具备 PR electronics A/S DDL 驱动的 HART 通讯器。
4. 通过通用软件，例如 DCS · PACTWare 等。

### 1: 回路通讯器

有关参数设置，请参阅下图和 PReset 软件中的帮助功能。  
回路通讯器不允许与危险 (Ex) 区域中安装的设备进行通信。

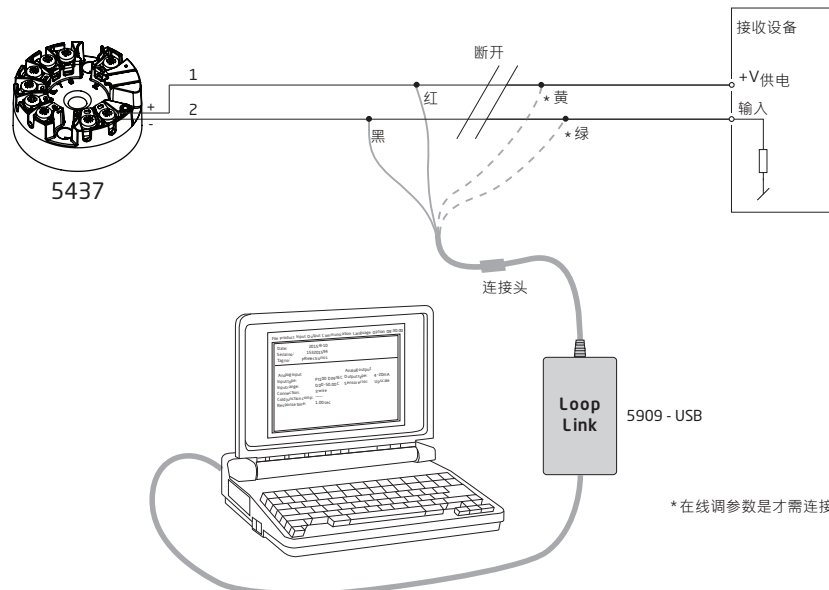

\* 在线调参数是才需连接

## 2: HART 调制解调器

有关参数设置·请参阅下图和 PReset 软件中的帮助功能。

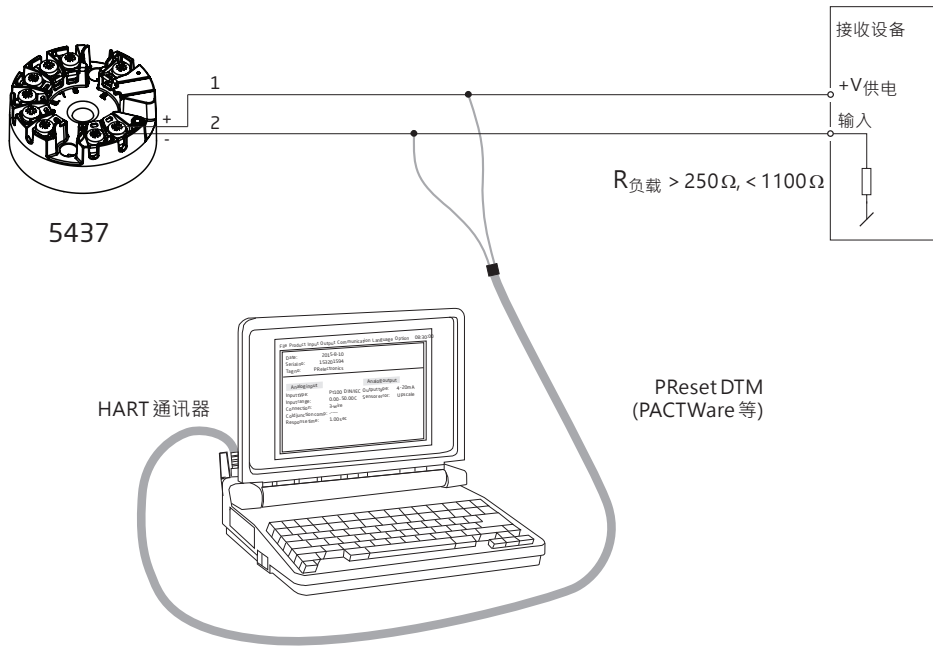

## 3: HART 通讯器

请参考下图。要访问特定产品菜单·HART 通信器必须装有 5437 DD 驱动文件。可以从 HART Communication Foundation 或 PR electronics 下载它们。

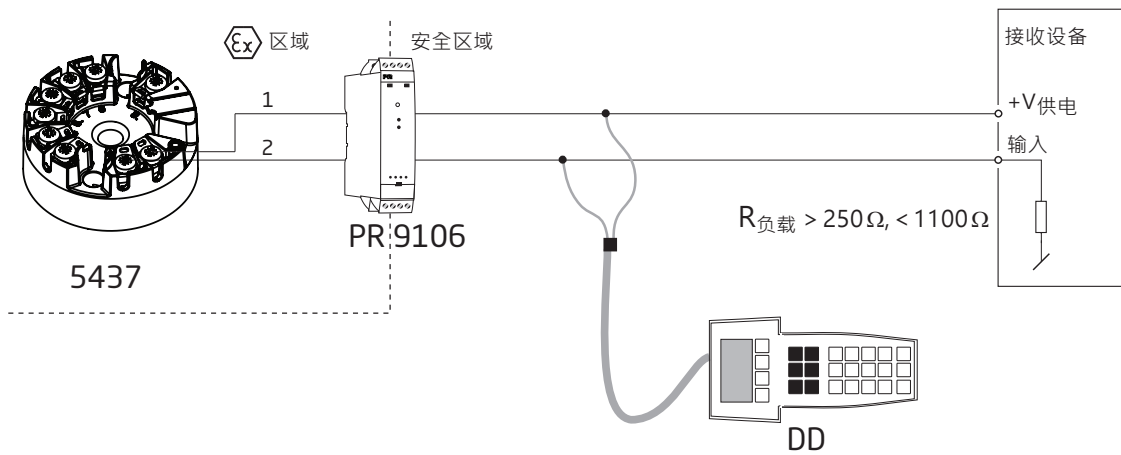



#### 4: 通用配置软件

支持 EDD 和 FDT / DTM 技术, 通过相关 DCS / 资产管理系统提供配置和监控, 并支持管理软件包, 例如 PACTware。

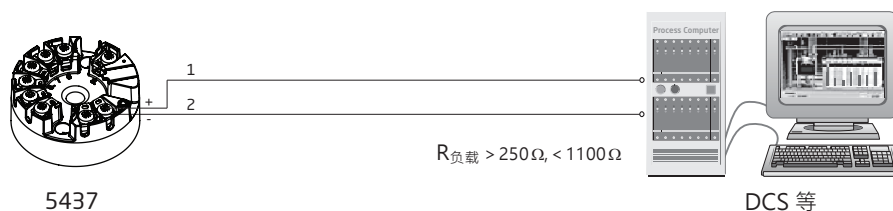

#### 变送器多点模式连接

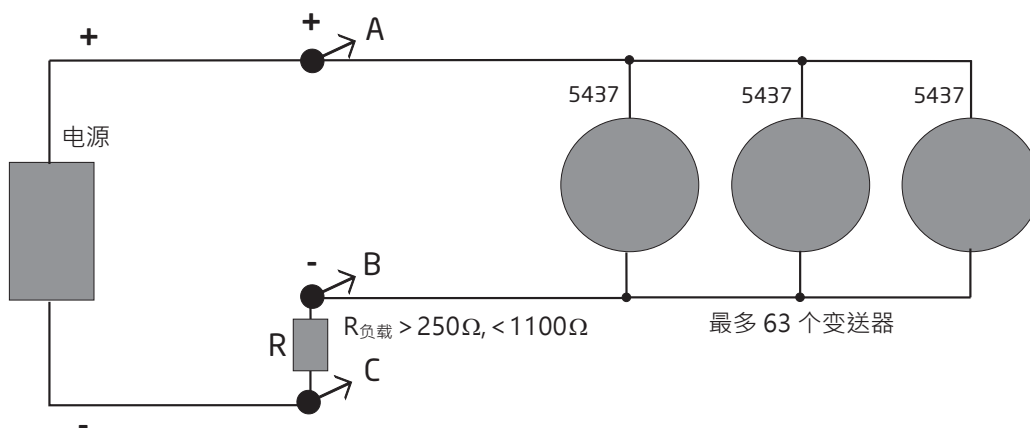

- 通过 HART 通信器或 HART 调制解调器进行通信。
- HART 通信器或 HART 调制解调器可以连接 AB 或 BC。
- 二线 HART 数字通讯, 可以并联连接最多 63 个变送器。
- 在连接之前, 每个变送器必须配置一个唯一的轮询地址, 范围从 1 到 63。如果两个变送器配置了相同的地址, 则两者都将被排除。变送器必须配置为多点模式 (固定输出 4 mA 不变)。因此, 回路中的最大电流为 252 mA。
- Preset 配置软件可以将单个变送器配置为多点模式, 并为其提供唯一的轮询地址。

# EMC 规格 – 抗干扰性

端口	IEC 61326-2-3, EN 61326-1 Industrial environment		NAMUR NE21 : 2007		IEC 61326-3-1		E10		PR 标准规格	
	现象	测试标准	测试值	标准	测试值	标准	安全功能测试值	标准	测试值	标准
外壳	ESD	IEC 61000-4-2	4 kV / 8 kV 接触/空气	B	6 kV / 8 kV 接触/空气	DS	6 kV / 8 kV 接触/空气	B	6 kV / 8 kV 接触/空气	A 1%
	高频场	IEC 61000-4-3	10 V/m: 80...1000 MHz 3 V/m: 1.4...2 GHz 1 V/m: 2...2.7 GHz	A	10 V/m: 80...2000 MHz 3 V/m: 2...2.7 GHz AM: 1 kHz 80%	DS	20 V/m: 80...1000 MHz 10 V/m: 1.4...2 GHz 3 V/m: 2...6 GHz AM: 1 kHz 80%	A	20 V/m: 80...1000 MHz 10 V/m: 1.4...2 GHz 3 V/m: 2...6 GHz AM: 1 kHz 80%	A 0.1%
	磁场	IEC 61000-4-8	30 A/m	A	100 A/m	DS	30 A/m	NA	30 A/m	A 0.1%
I/O 信号	突发	IEC 61000-4-4	1 kV / 5 kHz	B	1 kV / 5 kHz	DS	2 kV 持续时间 x 5	B	2 kV Duration x 5	A 1.0%
	浪涌	IEC 61000-4-5	1 kV - Line to ground	B	1 kV - Line to ground	DS	2 kV - Line to ground 脉冲数 x 3	B	2 kV - Line to ground 500 V - Differential 脉冲数 x 3	B
	Conducted RF	IEC 61000-4-6	3 V: 150 kHz...80 MHz AM: 1 kHz 80%	A	10 V: 10 kHz...80 MHz AM: 1 kHz 80%	DS	10 V: 150 kHz...80 MHz AM: 1 kHz 80%	A	10 V: 10 kHz...80 MHz AM: 1 kHz 80%	A 0.1%
	Conducted LF	IEC 61000-4-16	不需要		不需要	DS	1...10 V: 1.5...15 kHz 10 V: 15...150 kHz		1...10 V: 1.5...15 kHz 10 V: 15...150 kHz	A 0.1%

A: 测试期间，产品在规格范围内性能正常。

B: 测试期间，暂时性退化，或功能丧失，或性能可以自我恢复。

C: 测试期间，暂时性降级，或功能丧失，或性能需要操作员干预或系统复位。

## EMC 规格 – 辐射性能

Class B 设备		标准 CISPR 22	
干扰	测试方法	频率范围	极限
Radiated	Quasi-peak	30 to 230 MHz	30 dB (μV/m)
		230 to 1000 MHz	37 dB (μV/m)
Conducted	Quasi-peak	0.15...0.50 MHz	40 to 30 dB (μA)
	Average		30 to 20 dB (μA)
	Quasi-peak	0.50 to 30 MHz	30 dB (μA)
	Average		20 dB (μA)

E10 CISPR 16	
频率范围	极限
10...150 kHz	96 to 50 dB (μV)
150...350 kHz	60 to 50 dB (μV)
350 kHz...30 MHz	50 dB (μV)

# ATEX 安装图 5437QA01-V6R0

ATEX 证书

DEKRA 16ATEX 0047X

标准：

EN 60079-0:2012, A11:2013, EN 60079-11:2012,  
EN 60079-15:2010, EN 60079-7:2015

## Ex ia 安装

为了 5431D.., 5434D.., 5435D.., 5437B.. 和 5437D.. 安全安装，必须遵守以下规定。

标志



II 1 G Ex ia IIC T6...T4 Ga or  
II 2(1) G Ex ib [ia Ga] IIC T6...T4 Gb  
II 1 D Ex ia IIIC Da  
I M1 Ex ia I Ma

危险区域

Zone 0, 1, 2, 20, 21, 22 和 M1

未分类区域

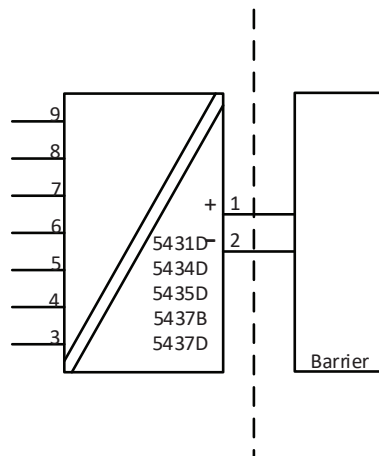

	端子 3,4,5,6 和 3,7,8,9	端子 3,4,5,6,7,8,9
Uo	7.2 VDC	7.2 VDC
Io:	7.3 mA	12.9 mA
Po	13.2 mW	23.3 mW
Lo:	667 mH	200 mH
Co	13.5 $\mu$ F	13.5 $\mu$ F

# Ex ib 安装

危险区域  
Zone 0, 1, 2,  
20, 21, 22 和 M1

危险区域  
Zone 1

未分类区域

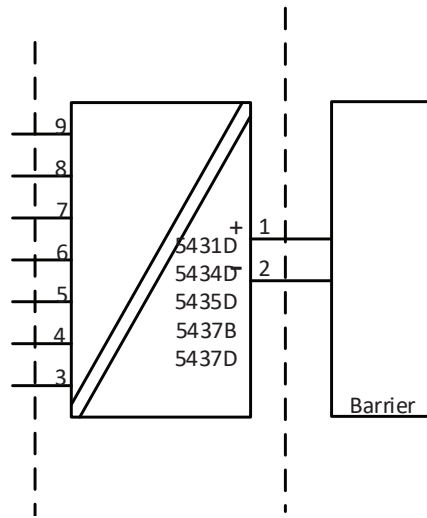

	端子 3,4,5,6 和 3,7,8,9	端子 3,4,5,6,7,8,9
Uo	7.2 VDC	7.2 VDC
Io:	7.3 mA	12.9 mA
Po	13.2 mW	23.3 mW
Lo:	667 mH	200 mH
Co	13.5 $\mu$ F	13.5 $\mu$ F

端子 1,2	温度范围
Ex ia 和 Ex ib 安装 Ui: 30 VDC; li: 120 mA; Li: 0 $\mu$ H; Ci: 1.0 nF	
Pi: 900 mW	T4: $-50 \leq Ta \leq 85^{\circ}\text{C}$ T5: $-50 \leq Ta \leq 65^{\circ}\text{C}$ T6: $-50 \leq Ta \leq 50^{\circ}\text{C}$
Pi: 750 mW	T4: $-50 \leq Ta \leq 85^{\circ}\text{C}$ T5: $-50 \leq Ta \leq 70^{\circ}\text{C}$ T6: $-50 \leq Ta \leq 55^{\circ}\text{C}$
Pi: 610 mW	T4: $-50 \leq Ta \leq 85^{\circ}\text{C}$ T5: $-50 \leq Ta \leq 75^{\circ}\text{C}$ T6: $-50 \leq Ta \leq 60^{\circ}\text{C}$

## 一般安装说明

产品制造年份可以从序列号的前两位数字中获取。

若外壳由非金属材料制成，或者虽然由金属制成，但漆面厚度小于 0.2 mm ( group IIC )，或等于 2 mm ( group IIB、IIA、I )，或漆面为任何厚度 ( group III )，则应避免出现静电放电。

对于 EPL Ga，若外壳由铝材质制成，则必须保证安装后由于冲击和摩擦引起的点火源不会产生火花

端子之间的距离 ( 包括裸线部分 ) 应距离任何接地金属至少 3 mm。

测试引脚允许直接测量回路电流，同时保持回路完整性。使用测试引脚时，变送器必须连接电源。对于危险区域安装，只能使用经过认证的测试设备。

如果变送器采用防护等级为 Ex nA 或 Ex ec，则可能不适用于本质安全。

### 对于安装在潜在爆炸性气体环境中，必须遵循以下说明：

变送器应安装于符合 DIN 43729 标准的 B 型外壳中，或同等级别符合 EN 60529 标准至少具备 IP20 防护等级的外壳。

外壳应适用于应用并正确安装。

### 对于安装在潜在爆炸性粉尘环境中，必须遵循以下说明：

变送器应安装于符合 DIN 43729 标准的 B 型金属材质外壳中，或同等级别符合 EN 60529 标准至少具备 IP5X 防护等级的外壳。外壳应适用于应用并正确安装。

电缆入口设备和盲塞元件应符合相同的要求。

对于 EPL Da，若粉尘层最大厚度为 5 mm 时，外壳表面温度 “T” 是环境温度 +20 K。

### 对于矿井安装，必须遵循以下说明：

变送器应安装于符合 EN 60529 标准至少具备 IP54 防护等级的金属材质外壳中。

铝材质外壳不允许用于矿井。

外壳应适用于应用并正确安装。

电缆入口设备和盲塞元件应符合相同的要求。

## Ex nA / Ex ec / Ex ic 安装

ATEX 证书 DEKRA 18ATEX0135X

为了 5431A.., 5434A.., 5435A.. 和 5437A.. 安全安装，必须遵守以下规定。

标志



II 3 G Ex nA IIC T6...T4 Gc  
 II 3 G Ex ec IIC T6...T4 Gc  
 II 3 G Ex ic IIC T6...T4 Gc  
 II 3 D Ex ic IIIC Dc

危险区域  
 Zone 2 和 22

未分类区域

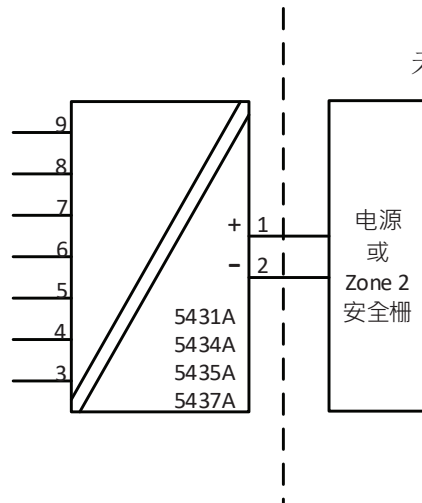

端子 1,2 Ex nA & ec	端子 1,2 Ex ic	端子 1,2 Ex ic	温度范围
$V_{max} = 37 \text{ VDC}$	$U_i = 37 \text{ VDC}$ $L_i = 0 \mu\text{H}$ $C_i = 1.0 \text{ nF}$	$U_i = 48 \text{ VDC}$ $P_i = 851 \text{ mW}$ $L_i = 0 \mu\text{H}$ $C_i = 1.0 \text{ nF}$	T4: $-50 \leq T_a \leq 85^\circ\text{C}$ T5: $-50 \leq T_a \leq 70^\circ\text{C}$ T6: $-50 \leq T_a \leq 55^\circ\text{C}$
$V_{max} = 30 \text{ VDC}$	$U_i = 30 \text{ VDC}$ $L_i = 0 \mu\text{H}$ $C_i = 1.0 \text{ nF}$		T4: $-50 \leq T_a \leq 85^\circ\text{C}$ T5: $-50 \leq T_a \leq 75^\circ\text{C}$ T6: $-50 \leq T_a \leq 60^\circ\text{C}$

端子 3,4,5,6,7,8,9 Ex nA & Ex ec	端子 3, 4, 5, 6 和 3, 7, 8, 9 Ex ic	端子 3,4,5,6,7,8,9 Ex ic
$V_{max} = 7.2 \text{ VDC}$	$U_o: 7.2 \text{ VDC}$ $I_o: 7.3 \text{ mA}$ $P_o: 13.2 \text{ mW}$ $L_o: 667 \text{ mH}$ $C_o: 13.5 \mu\text{F}$	$U_o: 7.2 \text{ VDC}$ $I_o: 12.9 \text{ mA}$ $P_o: 23.3 \text{ mW}$ $L_o: 200 \text{ mH}$ $C_o: 13.5 \mu\text{F}$

## 一般安装说明

若外壳由非金属材料制成，或者虽然由金属制成，但漆面厚度小于 0.2 mm ( group IIC )，或等于 2 mm ( group IIB、IIA、I )，或漆面为任何厚度 ( group III )，则应避免出现静电放电。

对于环境温度  $\geq 60^{\circ}\text{C}$ ，必须使用耐高温电缆，且其允许使用温度应至少高于环境温度 20K。

外壳应适用于应用并正确安装。

端子之间的距离 ( 包括裸线部分 ) 应距离任何接地金属至少 3 mm。

“测试”连接只能在安全区域下使用，或者电源/输出电路和加载的电流表是本质安全的。

### 对于安装在潜在爆炸性气体环境中，必须遵循以下说明：

变送器应安装于符合 EN 60079-0 标准至少具备 IP54 防护等级的外壳中。

此外，外壳应符合 EN 60664-1 标准规定的内部污染等级 2 或更高。

电缆入口设备和盲塞元件应符合相同的要求。

### 对于安装在潜在爆炸性粉尘环境中，必须遵循以下说明：

对于 EPL Dc，若粉尘层最大厚度为 5 mm 时，外壳表面温度“T”是环境温度 +20 K。

如果变送器连接本质安全信号“ic”，并且作为本质安全信号“ic”的接口界面 ( 例如无源设备 )，则变送器应安装于符合 DIN 43729 标准的 B 型外壳中，或同等级别符合 EN 60079-0 标准至少具备 IP54 防护等级的外壳。

电缆入口设备和盲塞元件应符合相同的要求。

如果变送器连接无火花信号“nA”，或者作为无火花信号“nA”的接口界面，则变送器应安装于符合 EN 60079-0 标准至少具备 IP54 防护等级，且符合防爆保护类型 Ex tD 或 Ex t 的外壳中。

电缆入口设备和盲塞元件应符合相同的要求。



# IECEX Installation drawing 5437QI01-V6R0

IECEX Certificate    IECEx DEK 16.0029X

Standards:            IEC60079-0:2011, IEC60079-11:2011,  
IEC60079-15:2010, IEC60079-7:2015

For safe installation of the 5431D...,5434D..., 5435D.. and 5437D.. the following must be observed.

Marking                Ex ia IIC T6...T4 Ga or  
Ex ib [ia Ga] IIC T6...T4 Gb  
Ex ia IIIC Da  
Ex ia I Ma

## Ex ia Installation

Hazardous Area  
Zone 0, 1, 2, 20, 21, 22 and M1

Unclassified Area

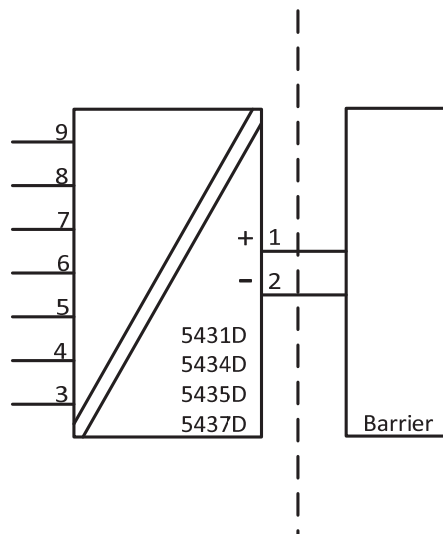

	<b>Terminal</b> 3,4,5,6 and 3,7,8,9	<b>Terminal</b> 3,4,5,6,7,8,9
Uo	7.2 VDC	7.2 VDC
Io:	7.3 mA	12.9 mA
Po	13.2 mW	23.3 mW
Lo:	667 mH	200 mH
Co	13.5 µF	13.5 µF

# Ex ib Installation

Hazardous Area  
Zone 0, 1, 2,  
20, 21, 22 and M1

Hazardous Area  
Zone 1

Unclassified Area

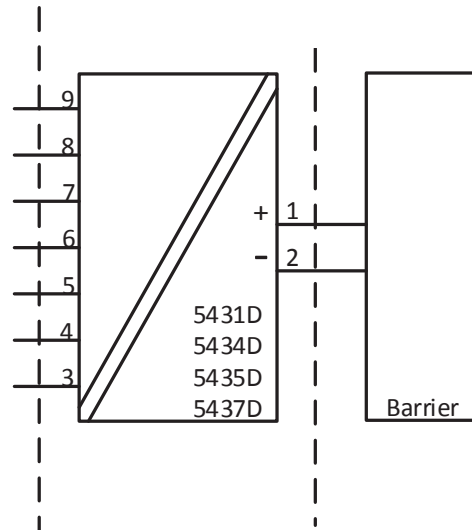

	<b>Terminal</b> 3,4,5,6 and 3,7,8,9	<b>Terminal</b> 3,4,5,6,7,8,9
Uo	7.2 VDC	7.2 VDC
Io:	7.3 mA	12.9 mA
Po	13.2 mW	23.3 mW
Lo:	667 mH	200 mH
Co	13.5 $\mu$ F	13.5 $\mu$ F

<b>Terminal 1,2</b> <b>Ex ia and Ex ib installation</b> Ui: 30 VDC; li: 120 mA; Li: 0 $\mu$ H; Ci: 1.0nF	<b>Temperature Range</b>
Pi: 900 mW	T4: $-50 \leq Ta \leq 85^{\circ}\text{C}$ T5: $-50 \leq Ta \leq 65^{\circ}\text{C}$ T6: $-50 \leq Ta \leq 50^{\circ}\text{C}$
Pi: 750 mW	T4: $-50 \leq Ta \leq 85^{\circ}\text{C}$ T5: $-50 \leq Ta \leq 70^{\circ}\text{C}$ T6: $-50 \leq Ta \leq 55^{\circ}\text{C}$
Pi: 610 mW	T4: $-50 \leq Ta \leq 85^{\circ}\text{C}$ T5: $-50 \leq Ta \leq 75^{\circ}\text{C}$ T6: $-50 \leq Ta \leq 60^{\circ}\text{C}$

## General installation instructions

If the enclosure is made of non-metallic materials or is made of metal having a paint layer thicker than 0,2 mm (group IIC), or 2 mm (group IIB, IIA, I), or any thickness (group III), electrostatic charges shall be avoided.

For EPL Ga, if the enclosure is made of aluminum, it must be installed such, that ignition sources due to impact and friction sparks are excluded

The distance between terminals, inclusive the wires bare part, shall be at least 3 mm separated from any earthed metal.

The test pins allow measurement of loop current directly while maintaining loop integrity. Power must be connected to the transmitter when using the test pins. For hazardous area installation, only certified test equipment may be used.

If the transmitter was applied in type of protection Ex nA or Ex ec, it may afterwards not be applied for intrinsic safety.

### **For installation in a potentially explosive gas atmosphere, the following instructions apply:**

The transmitter shall be mounted in an enclosure form B according to DIN43729 or equivalent that is providing a degree of protection of at least IP20 according to IEC60529.

The enclosure shall be suitable for the application and correctly installed.

### **For installation in a potentially explosive dust atmosphere, the following instructions apply:**

The transmitter shall be mounted in a metal enclosure form B according to DIN43729 or equivalent that is providing a degree of protection of at least IP5X according to IEC60529. The enclosure shall be suitable for the application and correctly installed.

Cable entry devices and blanking elements shall fulfill the same requirements.

For EPL Da, The surface temperature of the enclosure, for a dust layer with a maximum thickness of 5mm, is the ambient temperature +20 K.

### **For installation in mines the following instructions apply:**

The transmitter shall be mounted in a metal enclosure that is providing a degree of protection of at least IP54 according to IEC60529.

Aluminum enclosures are not allowed for mines.

The enclosure shall be suitable for the application and correctly installed.

Cable entry devices and blanking elements shall fulfill the same requirements.

## Ex nA / Ex ec / Ex ic Installation

For safe installation of the 5431A.., 5434A.., 5435A.. and 5437A.. the following must be observed.

Marking	Ex nA IIC T6...T4 Gc
	Ex ec IIC T6...T4 Gc
	Ex ic IIC T6...T4 Gc
	Ex ic IIIC Dc

Hazardous Area  
Zone 2 and 22

Unclassified Area

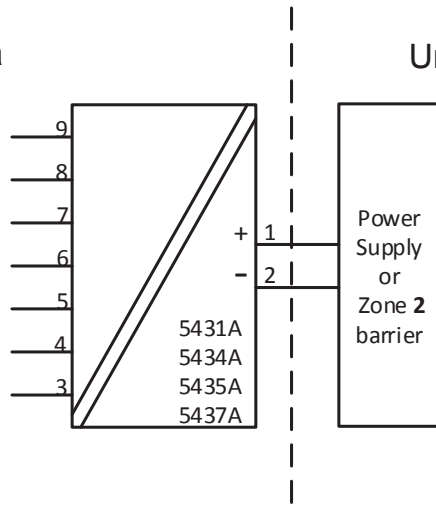

Terminal 1,2 Ex nA & ec	Terminal 1,2 Ex ic	Terminal 1,2 Ex ic	Temperature Range
Vmax= 37 VDC	Ui = 37 VDC Li = 0 μH Ci = 1.0 nF	Ui = 48 VDC Pi = 851 mW Li = 0 μH Ci = 1.0 nF	T4: -50 ≤ Ta ≤ 85°C T5: -50 ≤ Ta ≤ 70°C T6: -50 ≤ Ta ≤ 55°C
Vmax= 30 VDC	Ui = 30 VDC Li = 0 μH Ci = 1.0 nF		T4: -50 ≤ Ta ≤ 85°C T5: -50 ≤ Ta ≤ 75°C T6: -50 ≤ Ta ≤ 60°C

Terminal 3,4,5,6,7,8,9 Ex nA & Ex ec	Terminal 3, 4, 5, 6 and 3, 7, 8, 9 Ex ic	Terminal 3,4,5,6,7,8,9 Ex ic
Vmax = 7.2VDC	Uo: 7.2 VDC Io: 7.3 mA Po: 13.2 mW Lo: 667 mH Co: 13.5μF	Uo: 7.2 VDC Io: 12.9 mA Po: 23.3 mW Lo: 200 mH Co: 13.5μF

**General installation instructions**

If the enclosure is made of non-metallic materials, or if it is made of metal having a paint layer thicker than 0,2 mm (group IIC), or 2 mm (group IIB, IIA, I), or any thickness (group III), electrostatic charges shall be avoided.

For an ambient temperature ≥ 60°C, heat resistant cables shall be used with a rating of at least 20 K above the ambient temperature.

The enclosure shall be suitable for the application and correctly installed

The distance between terminals, inclusive the wires bare part, shall be at least 3 mm separated from any earthed metal.

'TEST' connection, may only be applied when the area is safe, or if supply / output circuit and the applied current meter are intrinsically safe.

**For installation in a potentially explosive gas atmosphere, the following instructions apply:**

The transmitter shall be installed in an enclosure providing a degree of protection of not less than IP54 in accordance with IEC 60079-0, which is suitable for the application and correctly installed e.g. in an enclosure that is in type of protection Ex n or Ex e. Additionally, the area inside the enclosure shall be pollution degree 2 or better as defined in IEC60664-1.

Cable entry devices and blanking elements shall fulfill the same requirements.

**For installation in a potentially explosive dust atmosphere, the following instructions apply:**

For EPL Dc, the surface temperature "T" of the enclosure, for a dust layer with a maximum thickness of 5 mm, is the ambient temperature +20 K.

If the transmitter is supplied with an intrinsically safe signal "ic" and interfaces an intrinsically safe signal "ic" (e.g. a passive device), the transmitter shall be mounted in a metal enclosure form B according to DIN 43729 or equivalent that provides a degree of protection of at least IP54 according to IEC60079-0.

Cable entry devices and blanking elements shall fulfill the same requirements.

If the transmitter is supplied with a non-sparking signal "nA", or interfaces a non-sparking signal, the transmitter shall be mounted in an enclosure, providing a degree of protection of at least IP54 according to IEC60079-0, and in conformance with type of protection Ex tD, or Ex t.

Cable entry devices and blanking elements shall fulfill the same requirements.

# CSA Installation drawing 5437QC01-V5R0

CSA Certificate 70066266

## Division 1 / Ex ia, Intrinsic Safe Installation

For safe installation of the 5431D., 5434D., 5435D. and 5437D. the following must be Observed.

Marking Class I Division 1, Group A,B,C,D  
 Class I, Zone 0: Ex/AEx ia IIC T6...T4  
 Ex/AEx ia IIC T6...T4  
 Ex/AEx ib [ja] IIC T6...T4

Hazardous Area  
 CL I, Div 1 GP ABCD or  
 CL I, Zone 0

Non Classified Area

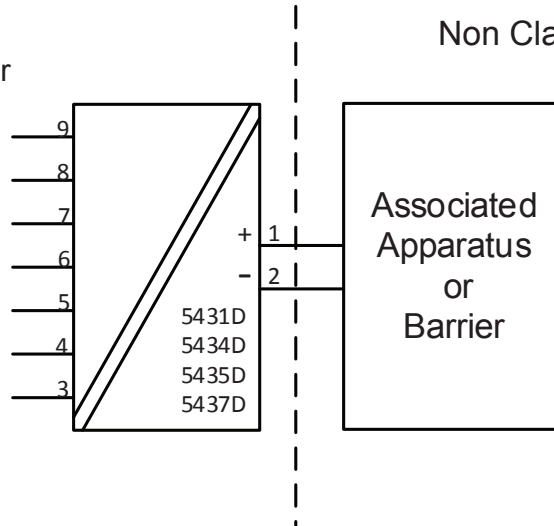

	Terminal 3,4,5,6 and 3,7,8,9	Terminal 3,4,5,6,7,8,9
Uo	7.2 VDC	7.2 VDC
Io:	7.3 mA	12.9 mA
Po	13.2 mW	23.3 mW
Lo:	667 mH	200 mH
Co	13.5 µF	13.5 µF

Um ≤ 250V  
 Voc or Uo ≤ Vmax or Ui  
 Isc or Io ≤ Imax or li  
 Po ≤ Pmax or Pi  
 Ca or Co ≥ Ci + Ccable  
 La or Lo ≥ Li + Lcable

Terminal 1,2 Ex ia, Div1 Ui: 30 VDC; li: 120 mA Li:0 µH; Ci:1.0nF	Temperature Range
Pi: 900 mW	T4: -50 ≤ Ta ≤ 85°C T5: -50 ≤ Ta ≤ 70°C T6: -50 ≤ Ta ≤ 55°C
Pi: 750 mW	T4: -50 ≤ Ta ≤ 85°C T5: -50 ≤ Ta ≤ 75°C T6: -50 ≤ Ta ≤ 60°C

### IS Installation instructions

- Install in accordance with the US the National Electrical Code (NEC) or for Canada the Canadian Electrical Code (CEC).
  - The transmitter must be installed in a suitable enclosure to meet installation codes stipulated in the Canadian Electrical Code (CEC) or for US the National Electrical Code (NEC).
  - To establish Class II and Class III, Division 1 or IIIC ratings, the equipment shall be installed in an enclosure that is approved for use in Class II and Class III hazardous (classified) locations.
  - If the enclosure is made of non-metallic materials or of painted metal, electrostatic charging shall be avoided.
- 
- Use supply wires with a rating of at least 5 K above the ambient temperature.

WARNING: Substitution of components may impair intrinsic safety

AVERTISSEMENT: la substitution de composants peut nuire à la sécurité intrinsèque

## Division 2 / Ex nA, Non Incendive Installation

For safe installation of the 5431A., 5434A., 5435A. and 5437A. the following must be observed.

Marking            Class I, Division 2, Groups A, B, C, D  
                         Class I, Zone 2: Ex/AEx nA IIC T6...T4  
                         Ex nA IIC T6...T4  
                         Class I, Zone 2: Ex/AEx nA [ic] IIC T6...T4  
                         Ex nA [ic] IIC T6...T4

Hazardous Area  
CL I, Div 2, GP ABCD  
CL I, Zone 2 IIC

Unclassified Area

**Terminal:  
3,4,5,6,7,8,9**  
Vmax: 7.2 VDC

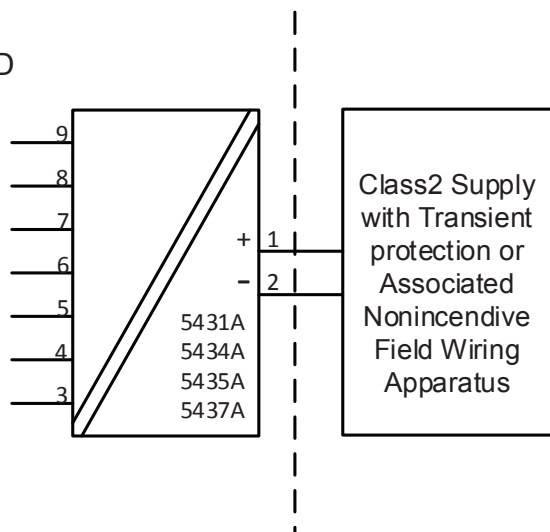

<b>Terminal 1,2</b> <b>Ex nA</b>	<b>Temperature Range</b>
Supply voltage: max 37 VDC	T4: $-50 \leq Ta \leq 85^{\circ}\text{C}$ T5: $-50 \leq Ta \leq 70^{\circ}\text{C}$ T6: $-50 \leq Ta \leq 55^{\circ}\text{C}$
Supply voltage: max 30 VDC	T4: $-50 \leq Ta \leq 85^{\circ}\text{C}$ T5: $-50 \leq Ta \leq 75^{\circ}\text{C}$ T6: $-50 \leq Ta \leq 60^{\circ}\text{C}$

### NI Installation instructions

- The transmitter must be installed in an enclosure providing a degree of protection of at least IP54 according to IEC60529 that is suitable for the application and is correctly installed. Cable entry devices and blanking elements shall fulfill the same requirements.
- If the enclosure is made of non-metallic materials or of painted metal, electrostatic charging shall be avoided.
- Use supply wires with a rating of at least 5 K above the ambient temperature.

WARNING: Substitution of components may impair suitability for Class I, Division 2  
 AVERTISSEMENT: la substitution de composants peut nuire à l'aptitude à la Classe I, Division 2

WARNING: Do not disconnect equipment unless power has been switched off or the area is known to be safe.

AVERTISSEMENT: Ne débranchez pas l'équipement sauf si l'alimentation a été coupée ou si la zone est connue pour être sûre.

### Non Incendive field wiring installation

The non incendive field Wiring Circuit concept allows interconnection of Nonincendive Field wiring Apparatus with Associated Nonincendive Field Wiring Apparatus or Assosicated Intrinsically Safe Apparatus or Associated Apparatus not specially examined in combination as a syatem using any of the wiring methods permitted for unclassified locations,  $V_{oc} < V_{max}$ ,  $C_a \geq C_i + C_{cable}$ ,  $L_a \geq L_i + L_{cable}$ .

<b>Terminal 1,2</b> <b>Non Incendive Field wiring parameters</b>	<b>Temperature Range</b>
$V_{max} = 30 \text{ VDC}$ , $C_i = 1\text{nF}$ , $L_i = 0$	T4: $-50 \leq Ta \leq 85^{\circ}\text{C}$ T5: $-50 \leq Ta \leq 75^{\circ}\text{C}$ T6: $-50 \leq Ta \leq 60^{\circ}\text{C}$

Functional Ratings:

$U_{nom} \leq 30 \text{ VDC}$ ;  $I_{nom} \leq 3.5 - 23 \text{ mA}$



# FM Installation drawing 5437QF01-V5R0

FM Certificates FM16CA0146X and FM16US0287X

## Division1 / Zone 0, Intrinsic Safe Installation

For safe installation of the 5431D.,5434D., 5435D.. and 5437D.. the following must be observed.

Marking: CL I, Div 1, Gp A,B,C,D  
 CL I, Zone 0 AEx ia IIC, T6...T4  
 CL I, Zone 1 [0] AEx ib [ja] IIC,T6...T4  
 Ex ia IIC, T6...T4 Ga  
 Ex ib [ja Ga] IIC, T6...T4 Gb

### Hazardous Area

CL I, Div 1, GP ABCD  
 CL I, Zone 0 IIC

### Non Classified Area

### Terminal:

**3,4,5,6,7,8,9**

Uo: 7.2 VDC

Io: 12.9 mA

Po: 23.3 mW

Lo: 200 mH

Co: 13.5 µF

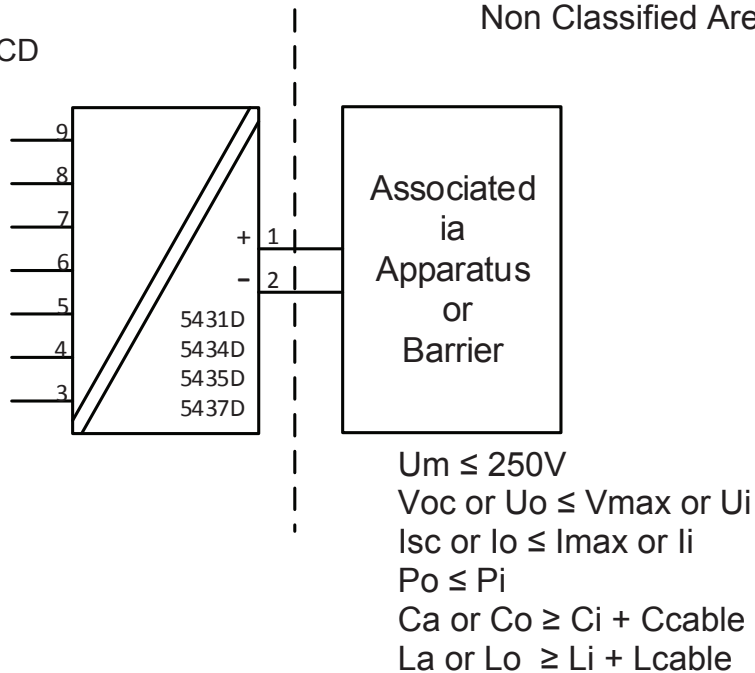

Terminal 1,2	Temperature Range
AEx/Ex ia IIC, T6...T4 Ga; CL I, Div 1, Gp ABCD, T6...T4;	
Ui: 30 VDC; li: 120 mA Pi: 900 mW Li:0 µH; Ci:1.0 nF	T4: -50 ≤ Ta ≤ 85°C T5: -50 ≤ Ta ≤ 70°C T6: -50 ≤ Ta ≤ 55°C
Ui: 30 VDC; li: 100 mA Pi: 750 mW Li:0 µH; Ci:1.0 nF	T4: -50 ≤ Ta ≤ 85°C T5: -50 ≤ Ta ≤ 75°C T6: -50 ≤ Ta ≤ 60°C

# Zone 0 / Zone 1, Intrinsic Safe Installation

Hazardous Area  
CL I, Zone 0 IIC

Hazardous Area  
CL I, Zone 1 IIC

Non Classified Area

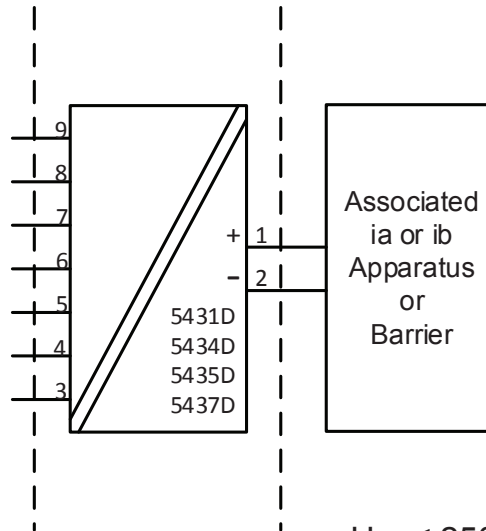

**Terminal:**

**3,4,5,6,7,8,9**  
 $U_o$ : 7.2 VDC  
 $I_o$ : 12.9 mA  
 $P_o$ : 23.3 mW  
 $L_o$ : 200 mH  
 $C_o$ : 13.5  $\mu$ F

$U_m \leq 250V$   
 $V_{oc}$  or  $U_o \leq V_{max}$  or  $U_i$   
 $I_{sc}$  or  $I_o \leq I_{max}$  or  $I_i$   
 $P_o \leq P_i$   
 $C_a$  or  $C_o \geq C_i + C_{cable}$   
 $L_a$  or  $L_o \geq L_i + L_{cable}$

Terminal 1,2	Temperature Range
Ex ib [ ia Ga ] IIC T6...T4 Gb; $U_i$ : 30 VDC; $I_i$ : 120 mA $P_i$ : 900 mW $L_i$ :0 $\mu$ H; $C_i$ :1.0nF	T4: $-50 \leq T_a \leq 85^\circ C$ T5: $-50 \leq T_a \leq 70^\circ C$ T6: $-50 \leq T_a \leq 55^\circ C$
$U_i$ : 30 VDC; $I_i$ : 100 mA $P_i$ : 750 mW $L_i$ :0 $\mu$ H; $C_i$ :1.0 nF	T4: $-50 \leq T_a \leq 85^\circ C$ T5: $-50 \leq T_a \leq 75^\circ C$ T6: $-50 \leq T_a \leq 60^\circ C$

### IS installation instructions

- Install in accordance with the US the National Electrical Code (NEC) or for Canada the Canadian Electrical Code (CEC).
- Equipment that is FM-approved for intrinsic safety may be connected to barriers based on the ENTITY CONCEPT. This concept permits interconnection of approved transmitters, meters and other devices in combinations which have not been specifically examined by FM, provided that the agency's criteria are met. The combination is then intrinsically safe, if the entity concept is acceptable to the authority having jurisdiction over the installation.
- The entity concept criteria are as follows:  
The intrinsically safe devices, other than barriers, must not be a source of power. The maximum voltage  $U_i$  ( $V_{max}$ ) and current  $I_i$  ( $I_{max}$ ), and maximum power  $P_i$  ( $P_{max}$ ), which the device can receive and remain intrinsically safe, must be equal to or greater than the voltage ( $U_o$  or  $V_{oc}$  or  $V_t$ ) and current ( $I_o$  or  $I_{sc}$  or  $I_t$ ) and the power  $P_o$  which can be delivered by the barrier.
- The sum of the maximum unprotected capacitance ( $C_i$ ) for each intrinsically device and the interconnecting wiring must be less than the capacitance ( $C_a$ ) which can be safely connected to the barrier.
- The sum of the maximum unprotected inductance ( $L_i$ ) for each intrinsically device and the interconnecting wiring must be less than the inductance ( $L_a$ ) which can be safely connected to the barrier.
- The entity parameters  $U_o, V_{oc}$  or  $V_t$  and  $I_o, I_{sc}$  or  $I_t$ , and  $C_a$  and  $L_a$  for barriers are provided by the barrier manufacturer.
- The transmitter must be installed in a suitable enclosure to meet installation codes stipulated in the Canadian Electrical Code (CEC) or for US the National Electrical Code (NEC).
- If the enclosure is made of non-metallic materials or of painted metal, electrostatic charging shall be avoided.
- Use supply wires with a rating of at least 5 K above the ambient temperature.

WARNING: Substitution of components may impair intrinsic safety

AVERTISSEMENT: la substitution de composants peut nuire à la sécurité intrinsèque

## Division 2 / Zone 2, Non Sparking Installation

For safe installation of the 5431A.., 5434A.., 5435A.. and 5437A.. the following must be observed.

Marking	Class I, Division 2, GP A,B,C,D T6...T4
	Class I, Zone 2 AEx nA IIC, T6...T4 Gc
	Class I, Zone 2 Ex nA IIC, T6...T4 Gc
	NIFW, CL I, Div 2, GP A,B,C,D

Hazardous Area  
 CL I, Div 2, GP ABCD  
 CL I, Zone 2 IIC

Unclassified Area

**Terminal:**  
**3,4,5,6,7,8,9**  
 Vmax: 7.2 VDC

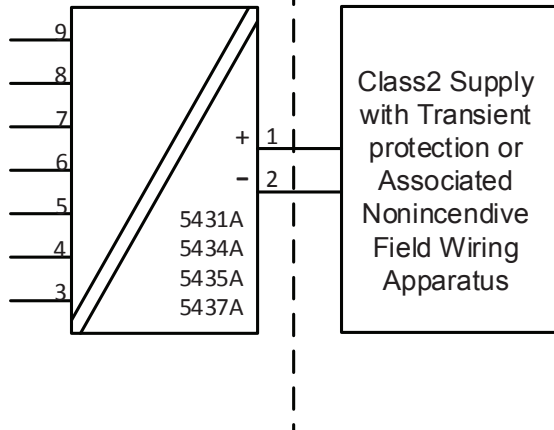

Terminal 1,2 AEx/Ex nA IIC T6..T4 Gc	Temperature Range
Supply voltage: max 37 VDC	T4: $-50 \leq Ta \leq 85^{\circ}\text{C}$ T5: $-50 \leq Ta \leq 70^{\circ}\text{C}$ T6: $-50 \leq Ta \leq 55^{\circ}\text{C}$
Supply voltage: max 30 VDC	T4: $-50 \leq Ta \leq 85^{\circ}\text{C}$ T5: $-50 \leq Ta \leq 75^{\circ}\text{C}$ T6: $-50 \leq Ta \leq 60^{\circ}\text{C}$

**NI Installation instructions**

- The transmitter must be installed in an enclosure providing a degree of protection of at least IP54 according to IEC60529 that is suitable for the application and is correctly installed. Cable entry devices and blanking elements shall fulfill the same requirements.
- If the enclosure is made of non-metallic materials or of painted metal, electrostatic charging shall be avoided.
- Use supply wires with a rating of at least 5 K above the ambient temperature.

WARNING: Substitution of components may impair suitability for Class I, Division 2  
 AVERTISSEMENT: la substitution de composants peut nuire à la sécurité intrinsèque

WARNING: Do not disconnect equipment unless power has been switched off or the area is known to be safe.

AVERTISSEMENT: Ne débranchez pas l'équipement sauf si l'alimentation a été coupée ou si la zone est connue pour être sûre.

## Non Incendive Field Wiring installation

The non incendive field Wiring Circuit concept allows interconnection of Nonincendive Field wiring Apparatus with Associated Nonincendive Field Wiring Apparatus or Associated Intrinsically Safe Apparatus or Associated Apparatus not specially examined in combination as a system using any of the wiring methods permitted for unclassified locations,  $V_{oc} < V_{max}$ ,  $C_a \geq C_i + C_{cable}$ ,  $L_a \geq L_i + L_{cable}$ .

Terminal 1,2 Non Incendive Field Wiring parameters	Temperature Range
V <sub>max</sub> = 30 VDC, C <sub>i</sub> =1nF, L <sub>i</sub> =0	T4: -50 ≤ T <sub>a</sub> ≤ 85°C T5: -50 ≤ T <sub>a</sub> ≤ 75°C T6: -50 ≤ T <sub>a</sub> ≤ 60°C

Functional Ratings:

U<sub>nom</sub> ≤ 30 VDC; I<sub>nom</sub> ≤ 3.5 - 23 mA

# Instalação INMETRO 5437QB01-V3R0

INMETRO Certificado DEKRA 16.0008X

Normas: ABNT NBR IEC60079-0:2013, ABNT NBR IEC60079-11:2013  
ABNT NBR IEC60079-15:2012

Para a instalação segura do 5431D.,5434D., 5435D.. e 5437D.. os seguintes pontos devem ser observados:

NOTAS Ex ia IIC T6...T4 Ga ou  
Ex ib [ja Ga] IIC T6...T4 Gb  
Ex ia IIIC Da  
Ex ia I Ma

## Instalação Ex ia

Área Classificada

Zone 0, 1, 2, 20, 21, 22 e M1

Área Não classificada

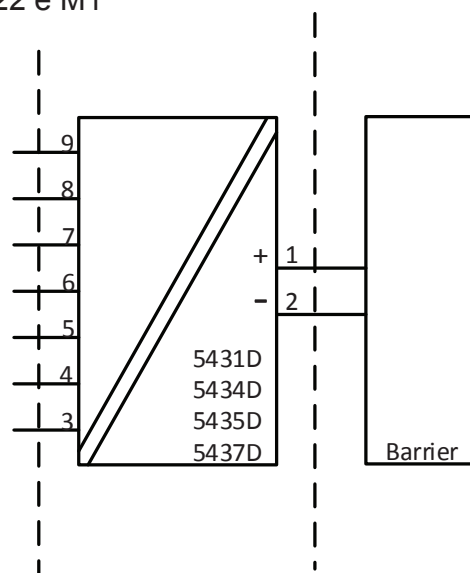

	<b>Terminais</b> 3,4,5,6 e 3,7,8,9	<b>Terminais</b> 3,4,5,6,7,8,9
Uo	7.2 VDC	7.2 VDC
Io:	7.3 mA	12.9 mA
Po	13.2 mW	23.3 mW
Lo:	667 mH	200 mH
Co	13.5 µF	13.5 µF

# Instalação Ex ib

Área Classificada  
Zonas 0, 1, 2,  
20, 21, 22 e Ma

Área Classificada  
Zona 1

Área Não Classificada

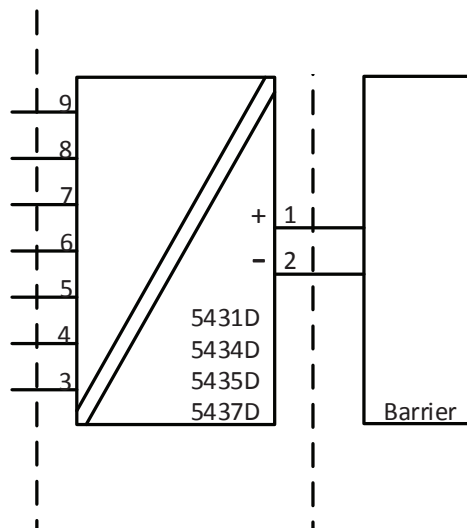

	Terminais 3,4,5,6 e 3,7,8,9	Terminais 3,4,5,6,7,8,9
Uo	7.2 VDC	7.2 VDC
Io:	7.3 mA	12.9 mA
Po	13.2 mW	23.3 mW
Lo:	667 mH	200 mH
Co	13.5 $\mu$ F	13.5 $\mu$ F

Terminais 1,2	Faixas de Temperaturas
<b>Instalações Ex ia e Ex ib</b> Ui: 30 VDC; li: 120 mA; Li: 0 $\mu$ H; Ci: 1.0nF	
Pi: 900 mW	T4: $-50 \leq Ta \leq 85^{\circ}\text{C}$ T5: $-50 \leq Ta \leq 65^{\circ}\text{C}$ T6: $-50 \leq Ta \leq 50^{\circ}\text{C}$
Pi: 750 mW	T4: $-50 \leq Ta \leq 85^{\circ}\text{C}$ T5: $-50 \leq Ta \leq 70^{\circ}\text{C}$ T6: $-50 \leq Ta \leq 55^{\circ}\text{C}$
Pi: 610 mW	T4: $-50 \leq Ta \leq 85^{\circ}\text{C}$ T5: $-50 \leq Ta \leq 75^{\circ}\text{C}$ T6: $-50 \leq Ta \leq 60^{\circ}\text{C}$

### **Instruções Gerais de Instalação**

Se o invólucro for feito de materiais não metálicos ou de metal com uma camada de tinta mais espessa que 0,2 mm (grupo IIC) ou 2 mm (grupo IIB, IIA, I) ou qualquer espessura (grupo III), cargas eletrostáticas devem ser evitadas.

Para EPL Ga, se o invólucro for de alumínio, ele deve ser instalado de forma que as fontes de ignição devido a faíscas de impacto e fricção sejam excluídas.

A distância entre terminais, fios inclusivos não isolados, deve ser separada por pelo menos 3 mm de qualquer metal aterrado.

Os pinos de testes para medição devem permitir os testes de *loop* de corrente mantendo a integridade do *loop*. A energia deve estar conectada ao transmissor quando for usado os pinos de teste. Para instalações em áreas classificadas deve ser utilizado somente equipamentos certificados.

Se o transmissor foi aplicado no tipo de proteção Ex nA e Ex ec, não pode ser aplicado para segurança intrínseca.

### **Para instalações com uma atmosfera de gás potencialmente explosiva, a seguinte instrução se aplicará:**

O transmissor deverá ser montado em um gabinete de formato tipo B de acordo com a norma DIN43729 ou equivalente que possibilita um grau mínimo de proteção IP20 de acordo com a ABNT NBR IEC60529.

O gabinete deve ser adequado para a aplicação e instalado corretamente.

### **Para instalação em uma atmosfera de poeira potencialmente explosiva, as seguintes instruções se aplicarão:**

O transmissor deverá ser montado em um gabinete de metal de formato B de acordo com a DIN43729 ou equivalente que possibilita um grau mínimo de proteção IP5X de acordo com a ABNT NBR IEC60529. O gabinete deve ser adequado para a aplicação e instalado corretamente.

Os dispositivos de entrada de cabos e os elementos espaçadores devem satisfazer os mesmos requisitos.

Para EPL Da, a temperatura máxima da superfície externa do gabinete é 20 K mais quente do que a máxima temperatura ambiente para uma camada de pó, com uma espessura de até 5 mm.

### **Para instalações em Minas, as instruções abaixo se aplicam:**

O transmissor deverá ser montado em um gabinete de metal que possibilita um grau mínimo de proteção IP54 de acordo com a ABNT NBR IEC60529

Gabinetes de Alumínio não são permitidos para instalações em Minas.

O gabinete deve ser adequado para a aplicação e instalado corretamente.

Os dispositivos de entrada de cabos e os elementos espaçadores devem satisfazer os mesmos requisitos



# Instalações Ex nA / Ex ic

Para instalações seguras do 5431A..., 5434A..., 5435A.. e 5437A.. as seguintes instruções devem ser observadas

Notas Ex nA IIC T6...T4 Gc  
 Ex ec IIC T6...T4 Gc  
 Ex ic IIC T6...T4 Gc  
 Ex ic IIIC Dc

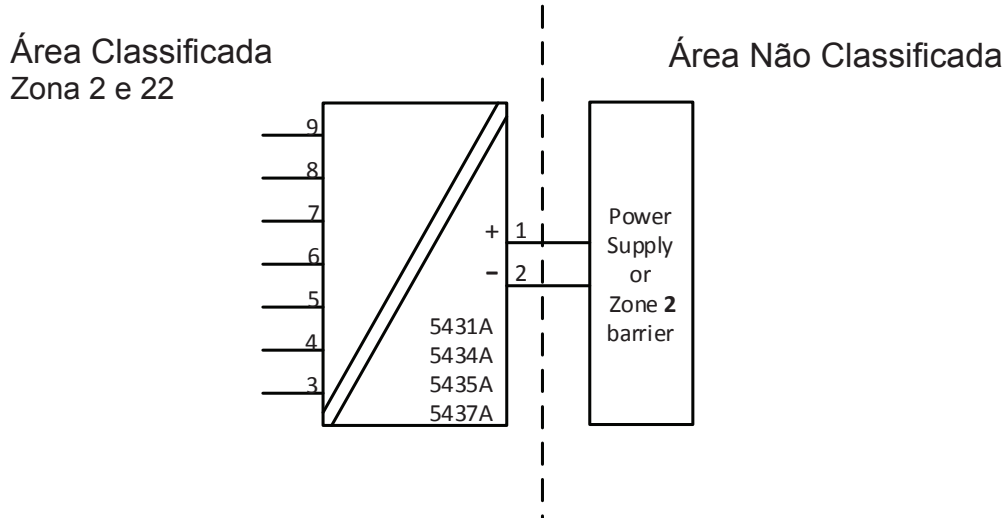

Terminais 1,2 Ex nA & ec	Terminais 1,2 Ex ic	Terminais 1,2 Ex ic	Faixa de Temperatura
Vmax= 37 VDC	Ui = 37 VDC Li = 0 µH Ci = 1.0 nF	Ui = 48 VDC Pi = 851 mW Li = 0 µH Ci = 1.0 nF	T4: -50 ≤ Ta ≤ 85°C T5: -50 ≤ Ta ≤ 70°C T6: -50 ≤ Ta ≤ 55°C
Vmax= 30 VDC	Ui = 30 VDC Li = 0 µH Ci = 1.0 nF		T4: -50 ≤ Ta ≤ 85°C T5: -50 ≤ Ta ≤ 75°C T6: -50 ≤ Ta ≤ 60°C

Terminais 3,4,5,6,7,8,9 Ex nA & Ex ec	Terminais 3, 4, 5, 6 and 3, 7, 8, 9 Ex ic	Terminais 3,4,5,6,7,8,9 Ex ic
Vmax = 7.2VDC	Uo: 7.2 VDC Io: 7.3 mA Po: 13.2 mW Lo: 667 mH Co: 13.5µF	Uo: 7.2 VDC Io: 12.9 mA Po: 23.3 mW Lo: 200 mH Co: 13.5µF

**Instruções gerais de instalação:**

Se o invólucro for feito de materiais não metálicos, ou se for feito de metal com uma camada de tinta mais espessa que 0,2 mm (grupo IIC), ou 2 mm (grupo IIB, IIA, I) ou qualquer espessura (grupo III), cargas eletrostáticas devem ser evitadas.

Para uma temperatura ambiente  $\geq 60^{\circ}\text{C}$ , cabos resistentes a aquecimento deverão ser usados com classificação de no mínimo 20 K acima da temperatura ambiente.

O gabinete deve ser adequado para a aplicação e instalado corretamente.

A distância entre terminais, fios inclusivos não isolados, deve ser separada por pelo menos 3 mm de qualquer metal aterrado.

A conexão TESTE, deve ser utilizado somente quando a área é segura, ou quando a fonte / circuito de saída e o medidor de corrente aplicado seja do tipo intrinsecamente seguro.

**Para instalações em uma atmosfera de gás potencialmente explosiva, as instruções abaixo e aplicação:**

O transmissor deverá ser instalado em um gabinete que possibilita um grau de proteção de no mínimo IP54 de acordo com a ABNT NBR IEC 60079-0.

Em adição, o gabinete deverá possibilitar um grau de poluição interna de 2 ou melhor, como definido na ABNT NBR IEC60664-1.

Os dispositivos de entrada de cabos e os elementos espaçadores devem satisfazer os mesmos requisitos

**Para a instalação em uma atmosfera de poeira potencialmente explosiva, as seguintes instruções se aplicarão:**

Para EPL Dc, a temperatura da superfície do invólucro é igual à temperatura ambiente mais 20 K, para uma camada de pó, com uma espessura de até 5 mm.

Se o transmissor de temperatura é alimentado com o sinal de segurança intrínseca "ic" e faz com um sinal de segurança intrínseco "ic" (exemplo de um dispositivo passivo), o transmissor deverá ser montado em um gabinete de metal de forma B de acordo com a DIN 43729 ou equivalente que possibilite um grau de proteção de no mínimo IP54 de acordo com a ABNT NBR IEC60079-0.

Os dispositivos de entrada de cabos e os elementos de supressão devem cumprir os mesmos requisitos.

Se o transmissor é alimentado com um sinal anti-faísca "nA", ou faz interface com um sinal anti-faísca, o transmissor deverá ser montado em um gabinete que, possibilite uma proteção mínima do tipo IP54 de acordo com a ABNT NBR IEC60079-0, e em conformidade com o tipo de proteção Ex tD, ou Ex t.

Os dispositivos de entrada de cabos e os elementos espaçadores devem satisfazer os mesmos requisitos

# NEPSI Installation drawing 5437QN01-V1R0

NEPSI 证书 GYJ18.1054X

防爆标志为 Ex ia IIC T4~ T6 Ga  
 Ex ib [ia Ga] IIC T4~ T6 Gb  
 Ex ic IIC T4/T5/T6 Gc  
 Ex nA [ic Gc] IIC T4~T6 Gc  
 Ex iaD 20 T80°C/T95°C/T130°C  
 Ex ibD [iaD 20] 21 T80°C/T95°C/T130°C

## 二、产品使用注意事项

1. 变送器的使用环境温度范围、温度组别与安全参数的关系如下表所示：

接线端子	防爆等级	环境温度	温度组别	安全参数
1, 2	ia, ib iaD, ibD	(-50~+50)°C	T6/T80°C	U <sub>i</sub> =30 V      I <sub>i</sub> =120 mV      P <sub>i</sub> =900 mW      L <sub>i</sub> ≈0 C <sub>i</sub> =1 nF
		(-50~+65)°C	T5/T95°C	
		(-50~+85)°C	T4/T130°C	
		(-50~+55)°C	T6/T80°C	U <sub>i</sub> =30 V      I <sub>i</sub> =120 mV      P <sub>i</sub> =750 mW      L <sub>i</sub> ≈0 C <sub>i</sub> =1 nF
		(-50~+70)°C	T5/T95°C	
		(-50~+85)°C	T4/T130°C	
	(-50~+60)°C	T6/T80°C	U <sub>i</sub> =30 V      I <sub>i</sub> =120 mV      P <sub>i</sub> =610 mW      L <sub>i</sub> ≈0 C <sub>i</sub> =1 nF	
	(-50~+75)°C	T5/T95°C		
	(-50~+85)°C	T4/T130°C		
	ic	(-50~+55)°C	T6	U <sub>i</sub> =37 V      L <sub>i</sub> ≈0      C <sub>i</sub> =1 nF      或 U <sub>i</sub> =48 V      P <sub>i</sub> =851 mW      L <sub>i</sub> ≈0      C <sub>i</sub> =1 nF
		(-50~+70)°C	T5	
		(-50~+85)°C	T4	
(-50~+60)°C		T6	U <sub>i</sub> =30 V      L <sub>i</sub> ≈0      C <sub>i</sub> =1 nF	
(-50~+75)°C		T5		
(-50~+85)°C		T4		
1, 2	nA	(-50~+55)°C	T6	U <sub>max</sub> =37 V
		(-50~+70)°C	T5	
		(-50~+85)°C	T4	
		(-50~+60)°C	T6	U <sub>max</sub> =30 V
		(-50~+75)°C	T5	
		(-50~+85)°C	T4	
3, 4, 5, 6, 7, 8, 9	ia, ib, ic	(-50~+85)°C		U <sub>o</sub> =7.2 V      I <sub>o</sub> =12.9 mA      P <sub>o</sub> =23.3 mW L <sub>o</sub> =200 mH      C <sub>o</sub> =13.5 μF

2. 变送器必须与已经通过防爆认证的关联设备配套/传感器共同组成本安防爆系统方可使用于爆炸性危险场所。其系统接线必须同时遵守本产品、所配关联设备和传感器的使用说明书要求，接线端子不得接错。

3. 用户不得自行更换该产品的零部件，应会同产品制造商共同解决运行中出现的故障，以杜绝损坏现象的发生。

4. 用户在安装、使用和维护变送器时，须同时严格遵守产品使用说明书和下列标准：

GB 3836.13-2013 爆炸性环境 第13部分：设备的修理、检修、修复和改造

GB 3836.15-2000 爆炸性气体环境用电气设备 第15部分：危险场所电气安装（煤矿除外）

GB 3836.16-2006 爆炸性气体环境用电气设备 第16部分：电气装置的检查和维护（煤矿除外）

GB 3836.18-2010 爆炸性环境第18部分：本质安全系统

GB 3836.20-2010 爆炸性环境第20部分：设备保护级别（EPL）为Ga级的设备

GB 50257-2014 电气装置安装工程爆炸和火灾危险环境电气装置施工及验收规范

GB 12476.2-2010 可燃性粉尘环境用电气设备 第2部分：选型和安装

GB 15577-2007 粉尘防爆安全规程

## Appendix A: Diagnostics overview

Incident Description	Description	LED reaction	Analog Output Reaction	NE-107 Class	User action	Error #
The device variable mapped to PV (and analog out put current) is beyond its operating limits.	Primary Value Out Of Limits	Flashing Red	Enters configured Value	Maintenance required	Reconnect or repair sensor	0
Any other device variable is beyond its operating limits.	Non-Primary Value Out Of Limits	Flashing Red	No impact	Maintenance required	Reconnect or repair sensor	1
The loop current has reached the Current Output Upper Limit (UL) or Output Lower Limit (LL) as configured with command #147, and is no longer corresponding to the PV value.	Loop Current Saturated	Flashing Red	Enters configured Value	If output range check is enabled: Failure otherwise Maintenance required	Reconnect or repair sensor	2
The analogue output current is being simulated or disabled.	Loop Current Fixed	Flashing Red	Enters configured Value	Function check	N.A.	3
The configuration has changed since this bit was last cleared (seen from same master type, Primary- or Secondary Master).	Configuration Changed	No Impact	No impact	N.A.	N.A.	6
A sensor error (broken/shorted sensor) is detected on Input 1	Primary Input 1 error	Flashing Red	Enters configured Value	If no backup input is available and mapped to PV, then failure otherwise maintenance required.	Reconnect or repair sensor	10
A sensor error (broken/shorted sensor) is detected on Input 2. This is only possible if Input type 2 is <> "None"	Primary Input 2 error (only if Input 2 is enabled)	Flashing Red	Enters configured Value	If no backup input is available and mapped to PV, then failure otherwise maintenance required.	Reconnect or repair sensor	11
A sensor error (broken/shorted sensor) is detected on the CJC measurement used for Input 1	CJC for Input 1 error (only if used)	Flashing Red	Enters configured Value	If no backup input is available and mapped to PV, then failure otherwise maintenance required.	Reconnect or repair sensor	12
A sensor error (broken/shorted sensor) is detected on the CJC measurement used for Input 2	CJC for Input 2 error (only if used)	Flashing Red	Enters configured Value	If no backup input is available and mapped to PV, then failure otherwise maintenance required.	Reconnect or repair sensor	13
The difference between measurements on Input 1 and Input 2 is outside the configured sensor drift limit	Dual Input: Sensor drift alarm (only if enabled)	Flashing Red	Enters configured Value	if sensor drift = error => failure otherwise maintenance required.	Reconnect or repair sensor	14
A sensor error (broken/shorted) is detected on the primary sensor, backup sensor is in use	Dual Input: Backup sensor OK, main sensor error	No Impact	No impact	Maintenance required	Reconnect or repair sensor	15
A sensor error (broken/shorted) is detected on the backup sensor, primary sensor only is available	Dual Input: Backup sensor error, main sensor OK	No Impact	No impact	Maintenance required	Reconnect or repair sensor	16
Configuration is temporarily invalid < 3 seconds, e.g. while downloading parameters	Configuration not supported by device	Flashing Red	Value is held (freeze)	Failure	N.A.	17

Incident Description	Description	LED reaction	Analog Output Reaction	NE-107 Class	User action	Error #
Configuration is temporary invalid > 3 seconds, e.g. if download is paused	Configuration not supported by device	Lights Red	Safe State	Failure	Correct and/or re-send the configuration	18
The device is operated outside its specified temperature range	Internal electronics temperature alarm	Flashing Red	No impact	Out of specification	Check operating temperature	19
The device is operated outside its specified temperature range in SIL mode	Internal electronics temperature alarm	Lights Red	Safe State	Failure	Check operating temperature	20
Power is applied but still too low	Minimum supply voltage not reached	Off	Safe State	Function check	Check power supply (at output terminals). If the error is persistent send in the device for repair	21
The device is transitioning to SIL mode, or have failed to do so	Attempting or failed to enter SIL mode	Lights Red	Safe State	Function check	The SIL configuration must be validated or normal operation must be re-selected	22
An unrecoverable error occurred in the internal communication to the Input CPU	Error in communication with Input CPU	Lights Red	Safe State	Failure	Reset or re-power the device. If the error is persistent send in the device for repair	23
An unrecoverable error occurred in the Input CPU	Input CPU reconfiguration failed	Lights Red	Safe State	Failure	Reset or re-power the device. If the error is persistent send in the device for repair	24
The device is operated below its specified voltage supply range	Supply voltage too low	Lights Red	Safe State	Failure	Check power supply (at output terminals). Reset or re-power the device. If the error is persistent send in the device for repair	25
The read back loop current differs from the calculated output current	Loop current read back error	Lights Red	Safe State	Failure	Check power supply (at output terminals). Reset or re-power the device. If the error is persistent send in the device for repair	26
The device is operated above its specified voltage supply range	Supply voltage too high	Lights Red	Safe State	Failure	Check power supply (at output terminals). Reset or re-power the device. If the error is persistent send in the device for repair	27
The configuration in the NVM has become inconsistent	Error in data verification after writing to EEPROM	Lights Red	Safe State	Failure	Correct and/or re-send the configuration. If the error is persistent send the device to repair	28
The configuration in the NVM has become inconsistent	CRC16 error in cyclic test of EEPROM	Lights Red	Safe State	Failure	Correct and/or re-send the configuration. If the error is persistent send the device to repair	29
An unrecoverable error occurred in the internal communication to the EEPROM	Error in EEPROM communication	Lights Red	Safe State	Failure	Reset or re-power the device. If the error is persistent send in the device for repair	30
An unrecoverable memory error occurred in the internal main CPU	CRC16 error in cyclic test of program code in FLASH	Lights Red	Safe State	Failure	Reset or re-power the device. If the error is persistent send in the device for repair	31
An exception error occurred in the main CPU program execution	Exception error during code execution	Lights Red	Safe State	Failure	Reset or re-power the device. If the error is persistent send in the device for repair	32
The main program was reset unintentionally due to a stuck up	Watchdog Reset Executed	Lights Red	Safe State	Failure	Correct and/or re-send the configuration. If the error is persistent send the device to repair	33
Sensor error is detected on the internal temperature sensor	Internal RTD sensor error	Lights Red	Safe State	Failure	Reset or re-power the device. If the error is persistent send in the device for repair	34
An unrecoverable memory error occurred in the internal main CPU	CRC16 error in cyclic test of safe-domain RAM contents	Lights Red	Safe State	Failure	Reset or re-power the device. If the error is persistent send in the device for repair	35

Incident Description	Description	LED reaction	Analog Output Reaction	NE-107 Class	User action	Error #
An exception error occurred in the main CPU program execution	Stack integrity error	Lights Red	Safe State	Failure	Reset or re-power the device. If the error is persistent send in the device for repair	36
An unrecoverable memory error occurred in the internal main CPU	CRC16 error in factory data in FLASH	Lights Red	Safe State	Failure	Reset or re-power the device. If the error is persistent send in the device for repair	37
An unrecoverable memory error occurred in the internal main CPU	RAM cell error	Lights Red	Safe State	Failure	Reset or re-power the device. If the error is persistent send in the device for repair	38
An unrecoverable memory error occurred in the internal main CPU	Safe domain RAM integrity error	Lights Red	Safe State	Failure	Reset or re-power the device. If the error is persistent send in the device for repair	39
An unrecoverable memory error occurred in the internal input CPU	CRC16 error in input CPU configuration	Lights Red	Safe State	Failure	Reset or re-power the device. If the error is persistent send in the device for repair	40
A critical measurement error is detected on internal voltage reference	Drift error, reference voltage FVR	Flashing Red	Safe State	Failure	Reconnect or repair sensor. If the error is persistent send in the device for repair	41
A critical measurement error is detected on internal voltage reference	Drift error, reference voltage VREF	Flashing Red	Safe State	Failure	Reconnect or repair sensor. If the error is persistent send in the device for repair	42
A critical measurement error is detected on Input 1	Drift error, primary Input 1	Flashing Red	Safe State	Failure	Reconnect or repair sensor. If the error is persistent send in the device for repair	43
A critical measurement error is detected on Input 2	Drift error, primary Input 2	Flashing Red	Safe State	Failure	Reconnect or repair sensor. If the error is persistent send in the device for repair	44
A critical measurement error is detected on the ground measurement	Drift error, ground voltage offset to terminal 3	Flashing Red	Safe State	Failure	Reconnect or repair sensor. If the error is persistent send in the device for repair	45
The device is in simulation mode and one or more of its Device Variables are not representative of the process	Device Variable Simulation Active	No Impact	No impact	N.A.	N.A.	46

## 文档更新记录

以下列表提供了有关本文档修订的说明。

版本号	日期	说明
101	1817	初次发布产品。
102	1908	EU RO 互认型式认证收到。 Appendix A 更新。
103	1924	版本5437B添加。 ATEX 安装图更新。
104	2004	ATEX · IECEx · CSA和INMETRO证书和安装图已更新。



# 无论您身在何处， 我们始终在您身边

无论您身在何处，都将获得我们标志性红色模块的全力支持

我们所有的产品都提供权威的专家服务，且享受长达五年的质量保证。您购买的每款产品都将获得个性化的技术支持和指导，按时交货，保修期内免费维修，丰富的技术文档等服务。

我们的总部在丹麦，并在世界各地设有办事处和授权合作伙伴，让我们能在全球范围内为您提供本地化服务。

这意味着我们总是在您身边，并且非常了解当地市场。我们致力于让您满意，并将 PERFORMANCE MADE SMARTER 这一理念传向世界。

了解更多有关我们的保修计划，或想与您所在地区的销售代表会面，请访问 [prelectronics.com](http://prelectronics.com)。

立即从

“PERFORMANCE MADE SMARTER”

受益

佩勒电子是一家领先于业内的·专注于使过程控制更加安全·可靠·高效的技术型公司。自1974年以来·我们一直致力于高精度-低功耗的核心技术开发·不断创新·帮助客户提高监测现场过程参数的能力。

我们的创新来源于强大的研发团队·以及和客户之间紧密的合作。简约·专注·勇气·卓越是我们的座右铭·指引我们不断帮助客户实现更高智能化。