



Displays Programmable displays with a wide selection of inputs and outputs for display of temperature, volume and weight, etc. Feature linearisation, scaling, and difference measurement functions for programming via PReset software.



Ex interfaces Interfaces for analogue and digital signals as well as HART® signals between sensors / I/P converters / frequency signals and control systems in Ex zone 0, 1 & 2 and for some modules in zone 20, 21 & 22.



Isolation Galvanic isolators for analogue and digital signals as well as HART® signals. A wide product range with both loop-powered and universal isolators featuring linearisation, inversion, and scaling of output signals.



Temperature A wide selection of transmitters for DIN form B mounting and DIN rail modules with analogue and digital bus communication ranging from application-specific to universal transmitters.



Universal PC or front programmable modules with universal options for input, output and supply. This range offers a number of advanced features such as process calibration, linearisation and auto-diagnosis.



- DK Side 1
- UK Page 13
- FR Page 25
- DE Seite 37



6 3 3 4

2-Wire Programmable Transmitter

No. 6334V104-IN (0915)
From ser. no. 060551001



SIGNALS THE BEST

2-TRÅDS PROGRAMMERBAR TRANSMITTER

PRetrans 6334

Indholdsfortegnelse

Sikkerhedsinstruktion	2
EF-overensstemmelseserklæring	3
Anvendelse	4
Teknisk karakteristik	4
Montage / installation.....	4
Applikationer	5
Bestillingsskema.....	6
Elektriske specifikationer	6
Tilslutninger	10
Blokdiagram	11
Programmering.....	12

Sikkerhedsinstruktion

• Ex-installation:

For sikker installation af 6334B i eksplosionsfarligt område skal følgende overholdes. Installation må kun foretages af kvalificeret personale, der er bekendt med de nationale og internationale love, direktiver og standarder, der gælder for området.

Følerkredsløbene er ikke ufejlbarligt galvanisk isoleret fra forsynings- og udgangskredsløbene, men den galvaniske isolation mellem kredsene kan modstå en testspænding på 500 VAC i 1 minut.

Ved installationer i eksplosive atmosfærer forårsaget af gasser, dampe eller tåger, hvor kategori 1G udstyr er krævet, skal elektrostatisk ladning på transmitters hus undgås.

Det er påkrævet, at forsynings- og udgangskredsløbene (terminal 11..13 og 21...23) er isoleret fra jord.

EF-OVERENSSTEMMELSESERKLÆRING

Som producent erklærer

PR electronics A/S
Lerbakken 10
DK-8410 Rønde

hermed at følgende produkt:

Type: 6334
Navn: 2-tråds programmerbar transmitter

er i overensstemmelse med følgende direktiver og standarder:

EMC-direktivet 2004/108/EF og senere tilføjelser

EN 61326-1 : 2006

For specifikation af det acceptable EMC-niveau henvises til modules elektriske specifikationer.

ATEX-direktivet 94/9/EF og senere tilføjelser

EN 50014 : 1997 + A1, A2, EN 50020 : 2002 og
EN 50284 : 1999
ATEX-certifikat: KEMA 06ATEX0115 X (6334B)

Der kræves ingen ændringer i produktet for at opnå overensstemmelse med de nye standarder:

EN 60079-0 : 2006 og EN 60079-11 : 2007

Bemyndiget organ:

UL International Demko A/S
Lyskær 8
P.O. Box 514
2730 Herlev
Danmark

Rønde, 17. april 2009



Peter Rasmussen
Producentens underskrift

2-TRÅDS PROGRAMMERBAR TRANSMITTER PRetrans 6334

- Indgang for TC
- Høj målenøjagtighed
- Galvanisk isolation
- Programmerbar følerfejlsværdi
- 1- eller 2-kanals version

Anvendelse:

- Lineariseret temperaturmåling med termoelementføler.
- Forstærkning af bipolære mV-signaler eventuelt lineariseret efter defineret lineariseringsfunktion til et 4...20 mA signal.

Teknisk karakteristik:

- PR6334 kan af brugeren i løbet af få sekunder programmeres til at måle inden for alle normerede TC-temperaturområder.
- CJC-kompensering med monteret CJC-stik.
- Udgangssignalet kan programmeres til en begrænsning.
- Der er løbende sikkerhedscheck af gemte data.

Montage / installation:

- Monteres på DIN-skinne, vertikalt eller horisontalt. Med 2-kanals versionen kan der installeres 84 kanaler pr. meter.
- **NB:** Som Ex-barriere for 6334B anbefaler vi 5104B, 5114B eller 5116B.

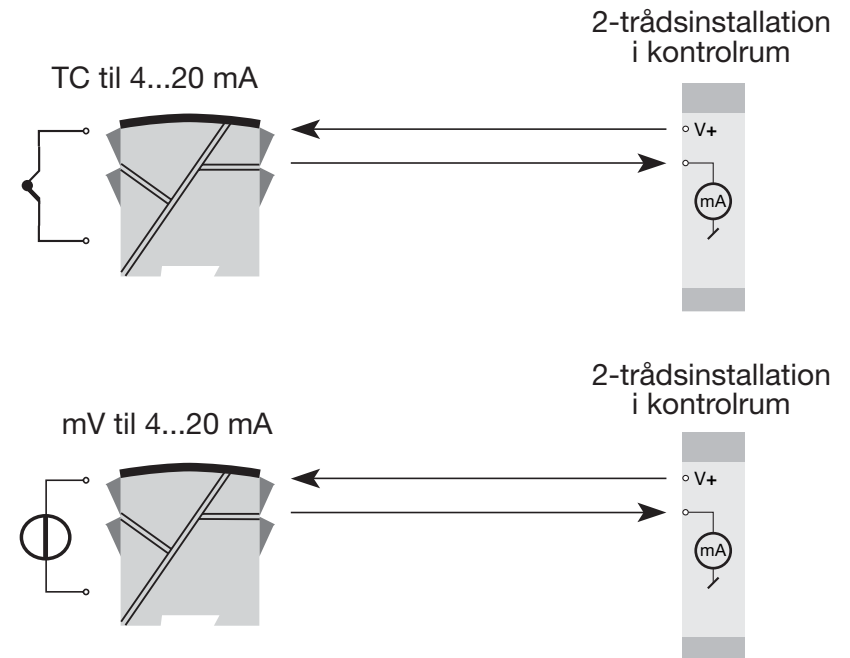

Bestillingsskema: 6334

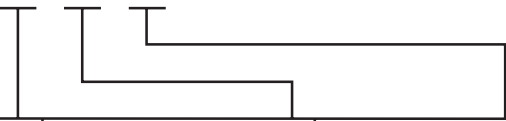

Type	Version	Galvanisk isolation	Kanaler
6334	Standard : A	1500 VAC : 2	Enkelt : A
	ATEX Ex : B		Dobbelt : B

Elektriske specifikationer:

Specifikationsområde:

-40°C til +60°C

Fælles specifikationer:

Forsyningsspænding DC

Standard	7,2...35 VDC
ATEX Ex.....	7,2...30 VDC
Egetforbrug, pr. kanal	0,17...0,8 W
Spændingsdrop.....	7,2 VDC
Isolationsspænding, test / drift	1,5 kVAC / 50 VAC
Isolationsspænding, kanal 1 / kanal 2:	
Standard	3,75 kVAC
ATEX Ex.....	1500 VAC
Opvarmningstid.....	5 min.
Kommunikationsinterface.....	Loop Link
Signal- / støjforhold.....	Min. 60 dB
Reaktionstid (programmerbar)	1...60 s
EEPROM fejlcheck	< 3,5 s
Signaldynamik, indgang.....	18 bit
Signaldynamik, udgang.....	16 bit
Kalibreringstemperatur.....	20...28°C
Nøjagtighed, størst af generelle og basisværdier:	

Generelle værdier

Indgangstype	Absolut nøjagtighed	Temperaturkoefficient
Alle	≤ ±0,05% af span	≤ ±0,01% af span / °C

Basisværdier

Indgangstype	Basisnøjagtighed	Temperaturkoefficient
Volt	≤ ±10 µV	≤ ±1 µV/°C
TC-type: E, J, K, L, N, T, U	≤ ±1°C	≤ ±0,05°C/°C
TC-type: B, R, S, W3, W5, LR	≤ ±2°C	≤ ±0,2°C/°C

EMC-immunitetspårvirkning.....	< ±0,5% af span
Udvidet EMC-immunitet:	
NAMUR NE 21, A kriterium, gniststøj	< ±1% af span

Virkning af forsyningsspændings-

ændring	< 0,005% af span / VDC
Max. ledningskvadrat.....	1 x 1,5 mm ² flerkeret ledning
Luffugtighed	< 95% RH (ikke kond.)
Mål.....	109 x 23,5 x 104 mm
Kapslingsklasse.....	IP20
Vægt (1 / 2 kanaler).....	145 / 185 g

Elektriske specifikationer, indgange:

Max. nulpunktsforskydning (offset)..... 50% af valgt max. værdi

TC-indgange:

Type	Min. temperatur	Max. temperatur	Min. span	Standard
B	+400°C	+1820°C	200°C	IEC584
E	-100°C	+1000°C	50°C	IEC584
J	-100°C	+1200°C	50°C	IEC584
K	-180°C	+1372°C	50°C	IEC584
L	-100°C	+900°C	50°C	DIN 43710
N	-180°C	+1300°C	100°C	IEC584
R	-50°C	+1760°C	200°C	IEC584
S	-50°C	+1760°C	200°C	IEC584
T	-200°C	+400°C	50°C	IEC584
U	-200°C	+600°C	75°C	DIN 43710
W3	0°C	+2300°C	200°C	ASTM E988-90
W5	0°C	+2300°C	200°C	ASTM E988-90
LR	-200°C	+800°C	50°C	GOST 3044-84

Koldt loddestedskomp. (CJC).....	< ±1,0°C
Følerfejlsdetektering	Ja
Følerfejlsstrøm:	
under detektering.....	Nom. 33 mA
ellers.....	0 mA
Spændingsindgange:	
Måleområde	-12...150 mV
Min. måleområde (span).....	5 mV
Indgangsmodstand	10 MΩ
Udgange:	
Strømodgange:	
Signalområde	4...20 mA
Min. signalområde.....	16 mA
Opdateringstid.....	440 ms
Udgangssignal ved EEpromfejl.....	≤ 3,5 mA
Belastningsmodstand.....	≤ (V _{forsyn.} - 7,2) / 0,023 [Ω]
Belastningsstabilitet	< ±0,01% af span / 100 Ω

Følerfejlsdetektering:

Programmerbar	3,5...23 mA
NAMUR NE43 Upscale	23 mA
NAMUR NE43 Downscale.....	3,5 mA

EEx- / I.S.-godkendelse - 6334B:

KEMA 06ATEX0115 X.....	 II 1 G
	EEx ia IIC T6...T5
Max. omgivelsestemperatur.....	T6: -40°C ≤ T _a ≤ 40°C
	T5: -40°C ≤ T _a ≤ 60°C
Anvendes i zone.....	0, 1 eller 2

Ex- / I.S.-data:

Udgang, klemme 11...13, (21...23):	
U _i	: 30 VDC
I _i	: 120 mADC
P _i	: 0,84 W
L _i	: 10 μH
C _i	: 1,0 nF

Indgang, klemme 41...44, (51...54):	
U _o	: 9,6 VDC
I _o	: 25 mADC
P _o	: 60 mW
L _o	: 33 mH
C _o	: 2,4 μF

GOST R godkendelse:

VNIIM & VNIIFTRI, Cert. no. Se www.preelectronics.dk

Overholdte myndighedskrav:

Standard:

EMC 2004/108/EF.....	EN 61326-1
ATEX 94/9/EF	EN 50014, EN 50020 og EN 50284

Af span = Af det aktuelt valgte område

Tilslutninger:

Indgange:

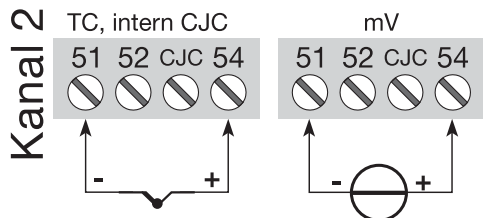
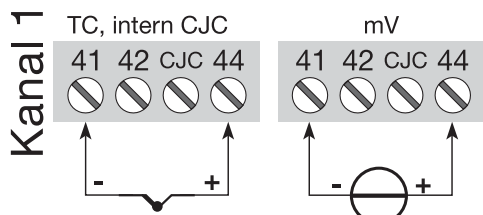

Udgange:

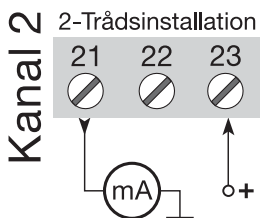
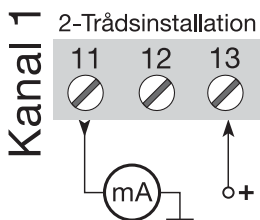

BLOKDIAGRAM:

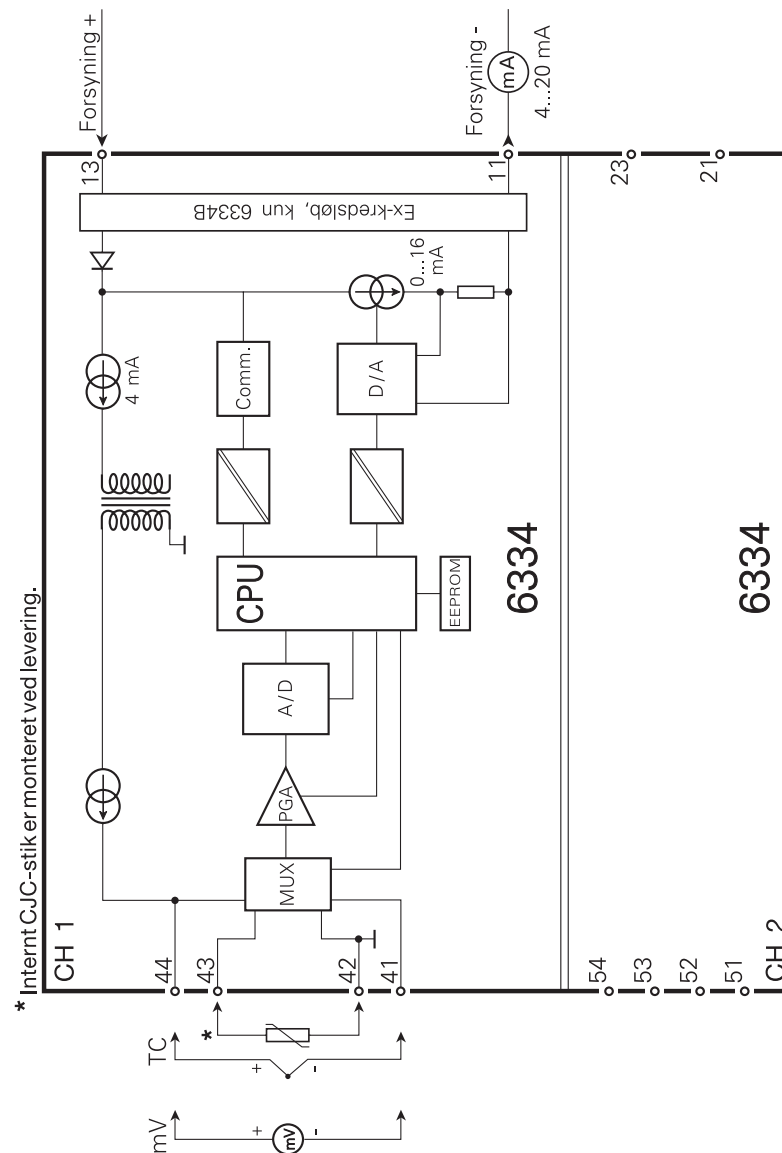

Programmering:

- Loop Link er et batteridrevet kommunikationsinterface, der er nødvendigt for programmering af PRetrans 6334.
- Ved programmering henvises til tegningen nedenfor og hjælpefunktionen i PReset programmet.
- Ved kommunikation med ikke-installerede moduler må stikkene 11, 12, 13 (kanal 1) og 21, 22, 23 (kanal 2) afmonteres, så kommunikationsinterfacets tilslutningsklemmer kan forbindes til stikbenene.
- Loop Link må ikke benyttes til kommunikation med moduler installeret i Ex-område.

Bestilling: Loop Link

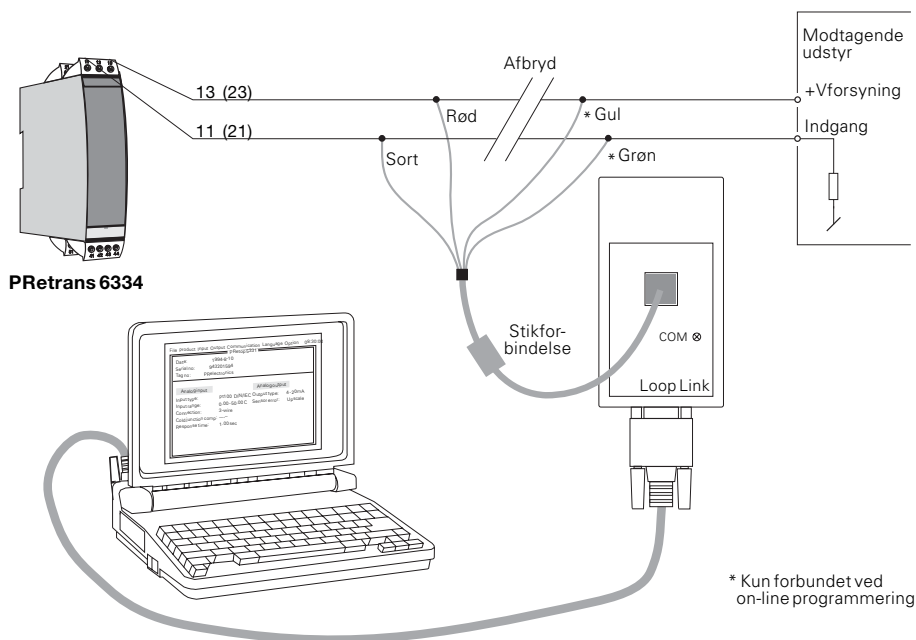

* Kun forbundet ved on-line programmering

2-WIRE PROGRAMMABLE TRANSMITTER

PRetrans 6334

Contents

Safety instructions.....	2
EC Declaration of Conformity	3
Application	4
Technical characteristics	4
Mounting / installation.....	4
Applications.....	5
Order	6
Electrical specifications.....	6
Connections	10
Block diagram	11
Programming.....	12

Safety instructions

- **Ex installation:**

For a safe installation of 6334B in hazardous area the following must be observed. The module must only be installed by qualified personnel who are familiar with the national and international laws, directives and standards that apply to this area.

Year of manufacture can be taken from the first two digits in the serial number.

The sensors circuit are not infallibly galvanically isolated from the supply and output circuits. However, the galvanic isolation between the circuits is capable of withstanding a test voltage of 500 Vac during 1 minute.

For applications in explosive atmospheres caused by gases, vapours or hazes and where category 1G apparatus is required, electrostatic charges on the housing of the 2-wire Programmable Transmitter shall be avoided.

It is required that at least the supply and output circuits (terminals 11..13, respectively 21..23) are kept isolated from ground.

EC DECLARATION OF CONFORMITY

As manufacturer

**PR electronics A/S
Lerbakken 10
DK-8410 Rønde**

hereby declares that the following product:

**Type: 6334
Name: 2-wire programmable transmitter**

is in conformity with the following directives and standards:

The EMC Directive 2004/108/EC and later amendments

EN 61326-1 : 2006

For specification of the acceptable EMC performance level, refer to the electrical specifications for the module.

The ATEX Directive 94/9/EC and later amendments

**EN 50014 : 1997 +A1, A2, EN 50020 : 2002 and
EN 50284 : 1999**

ATEX certificate: KEMA 06ATEX0115 X (6334B)

No changes are required to enable compliance with the replacement standards:

EN 60079-0 : 2006 and EN 60079-11 : 2007

Notified body:

**UL International Demko A/S
Lyskaer 8
P.O. Box 514
2730 Herlev
Denmark**

Rønde, 17 April 2009



Peter Rasmussen
Manufacturer's signature

2-WIRE PROGRAMMABLE TRANSMITTER PRetrans 6334

- *TC input*
- *High measurement accuracy*
- *Galvanic isolation*
- *Programmable sensor error value*
- *1- or 2-channel version*

Application:

- Linearised temperature measurement with TC sensor.
- Amplification of bipolar mV signals to a 4...20 mA signal, optionally linearised according to a defined linearisation function.

Technical characteristics:

- Within a few seconds the user can program PR6334 to measure temperatures within all TC ranges defined by the norms.
- Cold junction compensation (CJC) with a mounted CJC connector.
- A limit can be programmed on the output signal.
- Continuous check of vital stored data for safety reasons.

Mounting / installation:

- Mounted vertically or horizontally on a DIN rail. Using the 2-channel version up to 84 channels per metre can be mounted.
- **NB:** As Ex barrier for 6334B we recommend 5104B, 5114B, or 5116B.

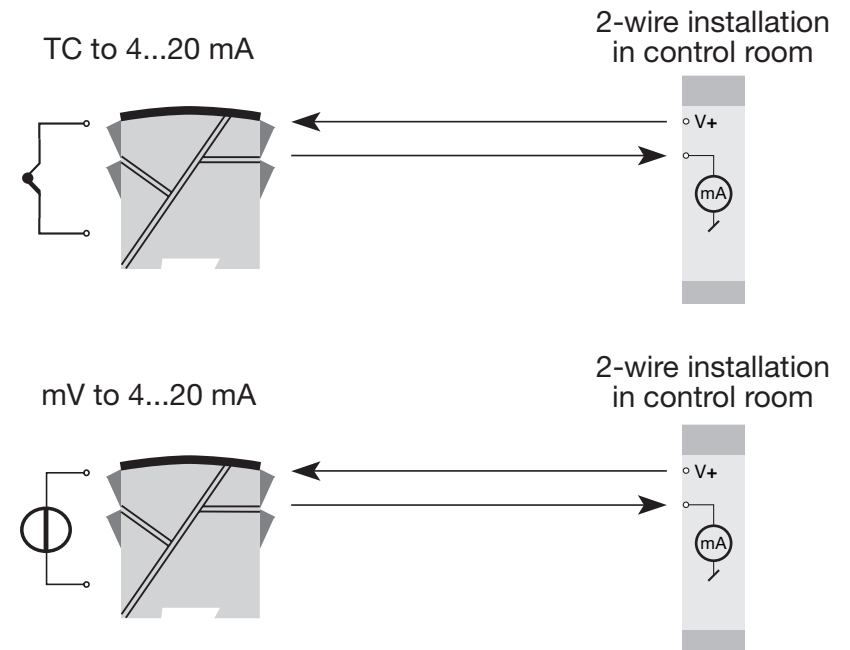

Order: 6334

Type	Version	Galvanic isolation	Channels
6334	Standard : A ATEX Ex : B	1500 VAC : 2	Single : A Double : B

Electrical specifications:

Specifications range:

-40°C to +60°C

Common specifications:

Supply voltage, DC

Standard 7.2...35 VDC

ATEX Ex..... 7.2...30 VDC

Internal consumption, per channel 0.17...0.8 W

Voltage drop 7.2 VDC

Isolation voltage, test / operation 1.5 kVAC / 50 VAC

Isolation voltage, channel 1 / channel 2:

Standard 3.75 kVAC

ATEX Ex..... 1500 VAC

Warm-up time..... 5 min.

Communications interface Loop Link

Signal / noise ratio Min. 60 dB

Response time (programmable)..... 1...60 s

EEPROM error check < 3.5 s

Signal dynamics, input..... 18 bit

Signal dynamics, output 16 bit

Calibration temperature 20...28°C

Accuracy, the greater of general and basic values:

General values		
Input type	Absolute accuracy	Temperature coefficient
All	≤ ±0.05% of span	≤ ±0.01% of span / °C

Basic values		
Input type	Basic accuracy	Temperature coefficient
Volt	≤ ±10 μV	≤ ±1 μV/°C
TC type: E, J, K, L, N, T, U	≤ ±1°C	≤ ±0.05°C/°C
TC type: B, R, S, W3, W5, LR	≤ ±2°C	≤ ±0.2°C/°C

EMC immunity influence	< ±0.5% of span
Extended EMC immunity: NAMUR NE 21, A criterion, burst	< ±1% of span

Effect of supply voltage variation..... < 0.005% of span / VDC

Max. wire size..... 1 x 1.5 mm² stranded wire

Humidity < 95% RH (non-cond.)

Dimensions..... 109 x 23.5 x 104 mm

Protection degree..... IP20

Weight (1 / 2 channels)..... 145 / 185 g

Electrical specifications, inputs:

Max. offset 50% of selec. max. value

TC inputs:

Type	Min. temperature	Max. temperature	Min. span	Standard
B	+400°C	+1820°C	200°C	IEC584
E	-100°C	+1000°C	50°C	IEC584
J	-100°C	+1200°C	50°C	IEC584
K	-180°C	+1372°C	50°C	IEC584
L	-100°C	+900°C	50°C	DIN 43710
N	-180°C	+1300°C	100°C	IEC584
R	-50°C	+1760°C	200°C	IEC584
S	-50°C	+1760°C	200°C	IEC584
T	-200°C	+400°C	50°C	IEC584
U	-200°C	+600°C	75°C	DIN 43710
W3	0°C	+2300°C	200°C	ASTM E988-90
W5	0°C	+2300°C	200°C	ASTM E988-90
LR	-200°C	+800°C	50°C	GOST 3044-84

Cold junction compensation < ±1.0°C

Sensor error detection	Yes
Sensor error current:	
When detecting	Nom. 33 mA
Else	0 mA
Voltage inputs:	
Measurement range	-12...150 mV
Min. span.....	5 mV
Input resistance.....	10 M Ω
Outputs:	
Current outputs:	
Signal range	4...20 mA
Min. signal range.....	16 mA
Updating time.....	440 ms
Output signal at EEprom error	≤ 3.5 mA
Load resistance.....	$\leq (V_{\text{supply}} - 7.2) / 0.023$ [Ω]
Load stability.....	$< \pm 0.01\%$ of span / 100 Ω
Sensor error detection:	
Programmable.....	3.5...23 mA
NAMUR NE43 Upscale	23 mA
NAMUR NE43 Downscale.....	3.5 mA
Ex / I.S. approval - 6334B:	
KEMA 06ATEX0115 X.....	Ex II 1 G
	EEx ia IIC T6...T5
Max. amb. temperature.....	T6: $-40^{\circ}\text{C} \leq T_a \leq 40^{\circ}\text{C}$
	T5: $-40^{\circ}\text{C} \leq T_a \leq 60^{\circ}\text{C}$
Applicable in zone.....	0, 1, or 2
Ex / I.S. data:	
Output, terminal 11...13, (21...23):	
U_j	: 30 VDC
I_j	: 120 mADC
P_j	: 0.84 W
L_j	: 10 μH
C_j	: 1.0 nF
Input, terminal 41...44, (51...54):	
U_o	: 9.6 VDC
I_o	: 25 mADC
P_o	: 60 mW
L_o	: 33 mH
C_o	: 2.4 μF

GOST R approval:

VNIIM & VNIIFTRI, Cert. no..... See www.preelectronics.com

Observed authority requirements: Standard:

EMC 2004/108/EC

EN 61326-1

ATEX 94/9/EC..... EN 50014, EN 50020 and EN 50284

Of span = Of the presently selected range

Connections:

Inputs:

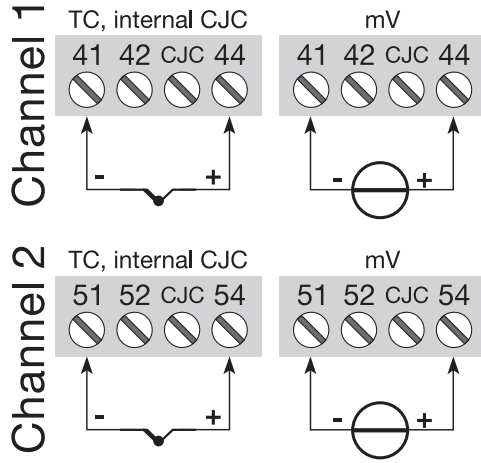

Outputs:

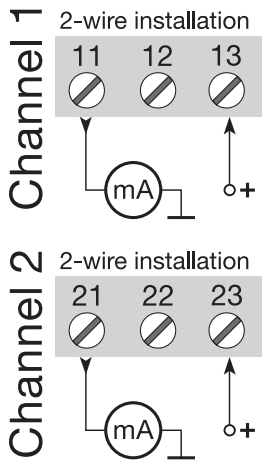

BLOCK DIAGRAM:

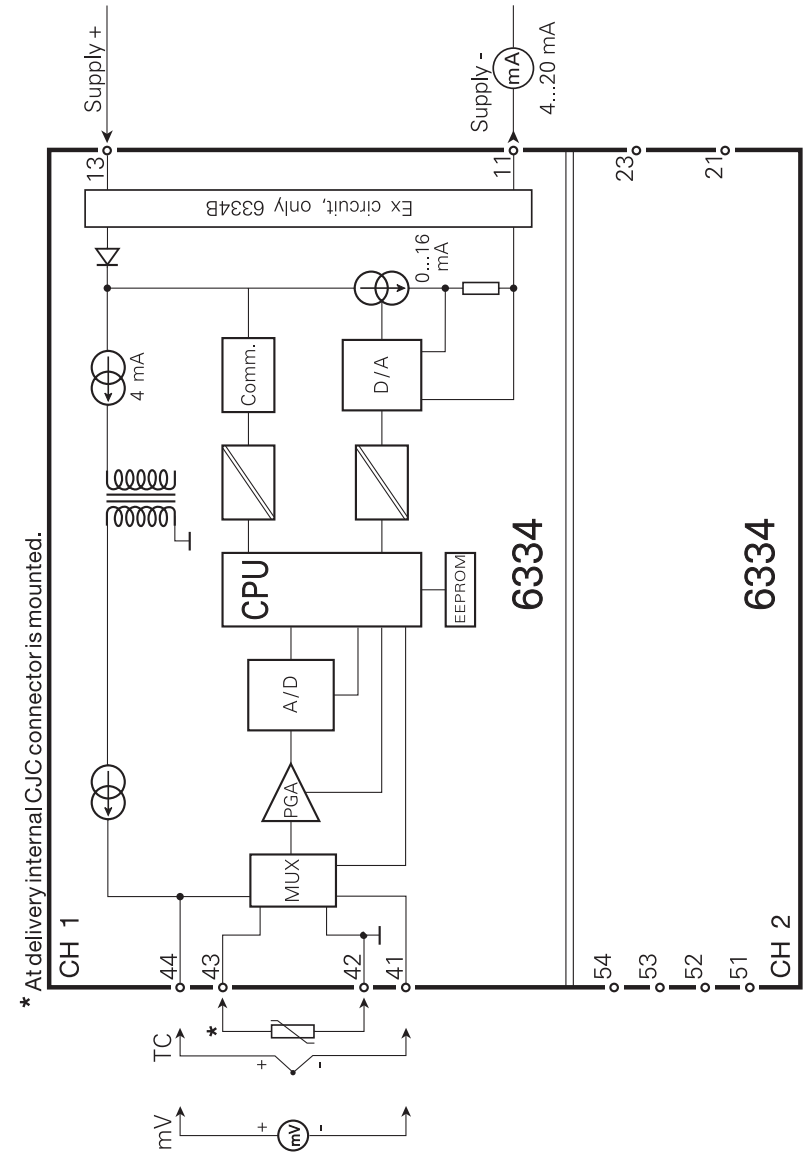

Programming:

- Loop Link is a battery-powered communications interface that is needed for programming PReTrans 6334.
- For programming please refer to the drawing below and the help functions in PReset.
- When communicating with non-installed modules, connectors 11, 12, 13 (channel 1) and 21, 22, 23 (channel 2) can be dismantled to connect the terminals of the communications interface to the pins.
- Loop Link is not approved for communication with modules installed in hazardous (Ex) area.

Order: Loop Link

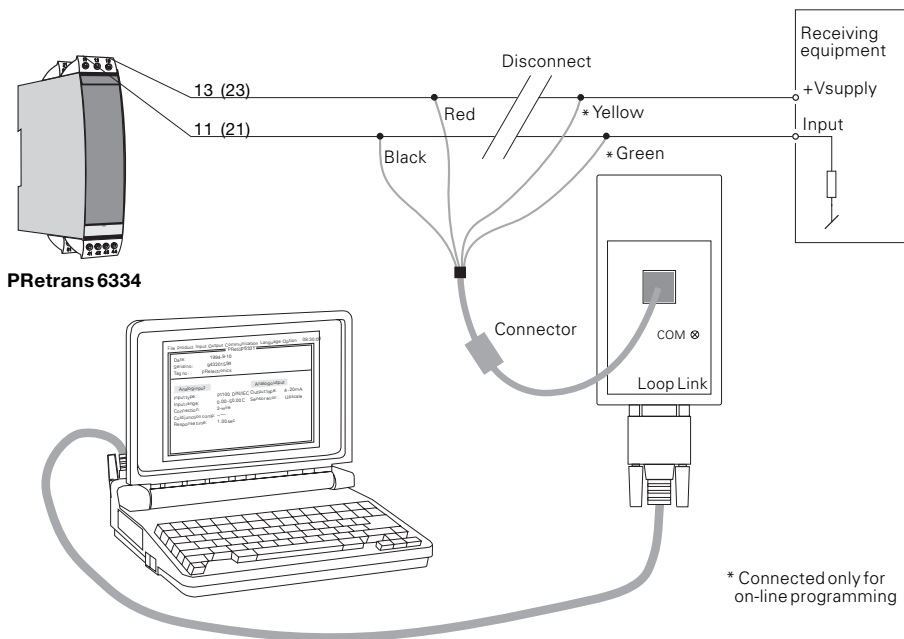

TRANSMETTEUR 2-FILS PROGRAMMABLE (TC)

PReTrans 6334

Sommaire

Consigne de sécurité	26
Déclaration de conformité CE	27
Application	28
Caractéristiques techniques	28
Montage / installation.....	28
Applications.....	29
Référence	30
Spécifications électriques	30
Connexions	34
Schéma de principe	35
Programmation.....	36

Consigne de sécurité

• Installation S.I. :

Pour l'installation de 6334B dans les zones dangereuses, conformez-vous aux consignes de sécurité suivantes : l'installation ne doit être réalisée que par du personnel qualifié connaissant la législation nationale et internationale ainsi que les directives et standards régissant ce domaine.

L'année de production ressort des deux premiers chiffres du numéro de série.

L'isolation galvanique entre les circuits du capteur et les circuits de l'alimentation et de l'entrée n'est pas infaillible. Cependant, l'isolation galvanique entre les circuits est capable de résister à une tension de test de 500 Vca pendant 1 minute.

Pour les installations dans les atmosphères explosibles dues à des gaz, vapeurs ou brouillards, exigeant des appareils de catégorie 1G, les décharges électrostatiques sur le boîtier du transmetteur doivent être évitées.

Il est exigé que les circuits de l'alimentation et de l'entrée (bornes 11...13 et 21...23) sont toujours isolés de la terre.

DECLARATION DE CONFORMITE CE

En tant que fabricant

**PR electronics A/S
Lerbakken 10
DK-8410 Rønde**

déclare que le produit suivant :

**Type : 6334
Nom : Transmetteur 2-fils programmable (TC)**

correspond aux directives et normes suivantes :

La directive CEM (EMC) 2004/108/CE et les modifications subséquentes
EN 61326-1 : 2006

Pour une spécification du niveau de rendement acceptable CEM (EMC) renvoyer aux spécifications électriques du module.

La directive ATEX 94/9/CE et les modifications subséquentes

**EN 50014 : 1997 + A1, A2, EN 50020 : 2002 et
EN 50284 : 1999
Certificat ATEX : KEMA 06ATEX0115 X (6334B)**

Aucune modification n'est exigée pour permettre la conformité aux normes de remplacement :

EN 60079-0 : 2006 et EN 60079-11 : 2007

Organisme notifié :

**UL International Demko A/S
Lyskaer 8
P.O. Box 514
2730 Herlev
Danemark**

Rønde, le 17 avril 2009



Peter Rasmussen
Signature du fabricant

TRANSMETTEUR 2-FILS PROGRAMMABLE (TC) PRetrans 6334

- *Entrée TC*
- *Grande précision de mesure*
- *Isolation galvanique*
- *Sécurité programmable*
- *Version 1- ou 2-voies*

Application :

- Mesure linéarisée de la température avec un capteur de thermocouples.
- Amplification des signaux mV bipolaires en un signal standard de 4...20 mA, éventuellement linéarisé suivant une fonction de linéarisation.

Caractéristiques techniques :

- Le PR6334 peut être programmé de manière simple et rapide.
- La compensation de soudure froide (CSF) est réalisée à l'aide d'un capteur de température intégré au module.
- Le signal de sortie peut être programmé avec un limite.
- Vérification continue des données sauvegardées.

Montage / installation :

- Pour montage vertical ou horizontal sur rail DIN. En version 2-voies, 84 voies par mètre peuvent être montées.
- **N.B. :** Comme barrière S.I. pour le 6334B nous recommandons le PR5104B, 5114B ou 5116B.

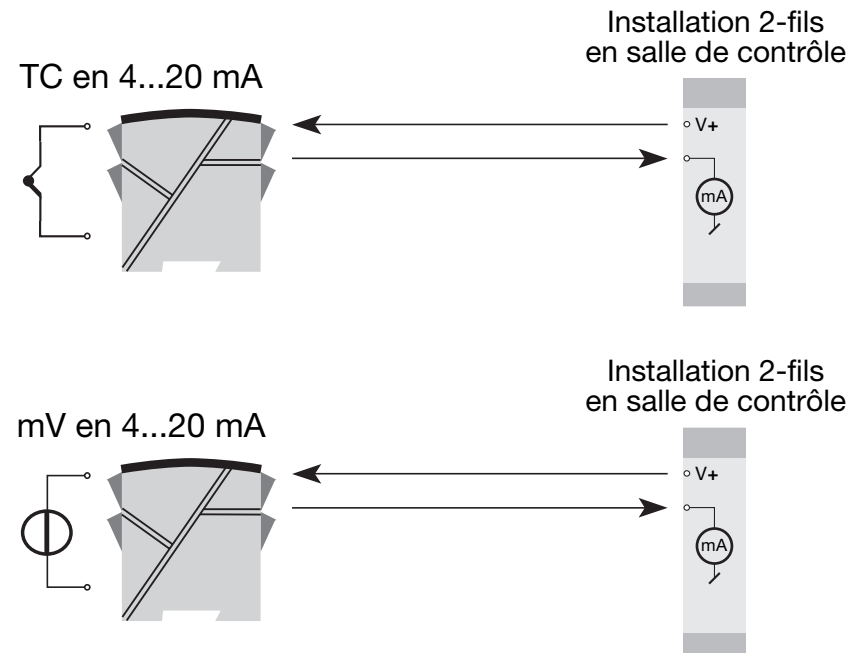

Référence : 6334

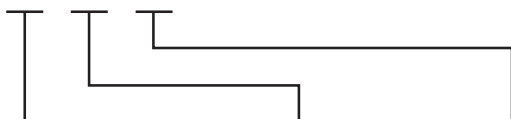

Type	Version	Isolation galvanique	Voies
6334	Standard : A	1500 Vca : 2	Une : A
	ATEX Ex : B		Deux : B

Spécifications électriques :

Plage des spécifications :

-40°C à +60°C

Spécifications communes :

Tension d'alimentation cc

Standard 7,2...35 Vcc

ATEX Ex..... 7,2...30 Vcc

Consommation interne, par voie..... 0,17...0,8 W

Chute de tension..... 7,2 Vcc

Tension d'isolation, test / opération..... 1,5 kVca / 50 Vca

Tension d'isolation, voie 1 / voie 2 :

Standard 3,75 kVca

ATEX Ex..... 1500 Vca

Temps de chauffe..... 5 min.

Kit de programmation Loop Link

Rapport signal / bruit Min. 60 dB

Temps de réponse (programmable) 1...60 s

Vérification de l'EEPROM..... < 3,5 s

Dynamique du signal d'entrée 20 bit

Dynamique du signal de sortie 16 bit

Température d'étalonnage 20...28°C

Précision, la plus grande des valeurs générales et de base :

Valeurs générales		
Type d'entrée	Précision absolue	Coefficient de température
Tous	≤ ±0,05% de l'EC	≤ ±0,01% de l'EC / °C

Valeurs de base		
Type d'entrée	Précision de base	Coefficient de température
Volt	≤ ±10 µV	≤ ±1 µV/°C
Type TC : E, J, K, L, N, T, U	≤ ±1°C	≤ ±0,05°C/°C
Type TC : B, R, S, W3, W5, LR	≤ ±2°C	≤ ±0,2°C/°C

Immunité CEM..... < ±0,5% de l'EC
 Immunité CEM améliorée :
 NAMUR NE 21, critère A, burst < ±1% de l'EC

Effet d'une variation

de la tension d'alimentation..... < 0,005% de l'EC / Vcc

Taille max. des fils 1 x 1,5 mm² fil multibrins

Humidité < 95% HR (sans cond.)

Dimensions..... 109 x 23,5 x 104 mm

Degré de protection IP20

Poids (1 / 2 voies)..... 145 / 185 g

Spécifications électriques, entrées :

Décalage max. 50% de la valeur max. sélectionnée

Entrées TC :

Type	Température min.	Température max.	Plage min.	Standard
B	+400°C	+1820°C	200°C	IEC584
E	-100°C	+1000°C	50°C	IEC584
J	-100°C	+1200°C	50°C	IEC584
K	-180°C	+1372°C	50°C	IEC584
L	-100°C	+900°C	50°C	DIN 43710
N	-180°C	+1300°C	100°C	IEC584
R	-50°C	+1760°C	200°C	IEC584
S	-50°C	+1760°C	200°C	IEC584
T	-200°C	+400°C	50°C	IEC584
U	-200°C	+600°C	75°C	DIN 43710
W3	0°C	+2300°C	200°C	ASTM E988-90
W5	0°C	+2300°C	200°C	ASTM E988-90
LR	-200°C	+800°C	50°C	GOST 3044-84

Compensation de soudure froide	< ±1,0°C
Détection de rupture sonde	Oui
Courant de sonde :	
Pendant la détection.....	Nom. 33 mA
Si non.....	0 mA

Entrées tension :

Gamme de mesure.....	-12...150 mV
Plage de mesure min	5 mV
Résistance d'entrée	10 MΩ

Sorties :

Sorties courant :

Gamme de mesure.....	4...20 mA
Plage de mesure min	16 mA
Temps de scrutation.....	440 ms
Sortie en cas de corruption de l'EEProm....	≤ 3,5 mA
Résistance de charge.....	≤ (V _{alim.} - 7,2) / 0,023 [Ω]
Stabilité de charge	< ±0,01% de l'EC / 100 Ω

Détection de rupture de sonde :

Programmable.....	3,5...23 mA
NAMUR NE43 Haut d'échelle	23 mA
NAMUR NE43 Bas d'échelle.....	3,5 mA

Approbation EEx / S.I. - 6334B :

KEMA 06ATEX0115 X.....	 II 1 G
	EEx ia IIC T6...T5
Température ambiante max.	T6: -40°C ≤ T _a ≤ 40°C
	T5: -40°C ≤ T _a ≤ 60°C
Zones d'application.....	0, 1 ou 2

Caractéristiques S.I. :

Sortie, borne 11...13, (21...23) :	
U _i	: 30 Vcc
I _i	: 120 mAcc
P _i	: 0,84 W
L _i	: 10 μH
C _i	: 1,0 nF

Entrée, borne 41...44, (51...54) :	
U _o	: 9,6 Vcc
I _o	: 25 mAcc
P _o	: 60 mW
L _o	: 33 mH
C _o	: 2,4 μF

Approbation GOST R :

VNIIM & VNIIFTRI, Cert. no. Voir www.preelectronics.fr

Agréments et homologations : Standard :

CEM 2004/108/CE	EN 61326-1
ATEX 94/9/CE.....	EN 50014, EN 50020 et EN 50284

EC = Echelle configurée

Connexions :

Entrées :

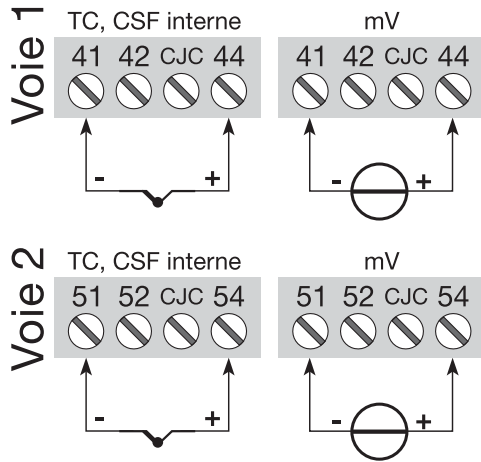

Sorties :

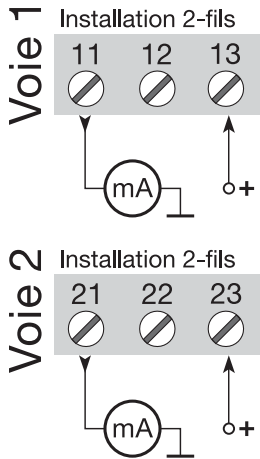

SCHEMA DE PRINCIPE :

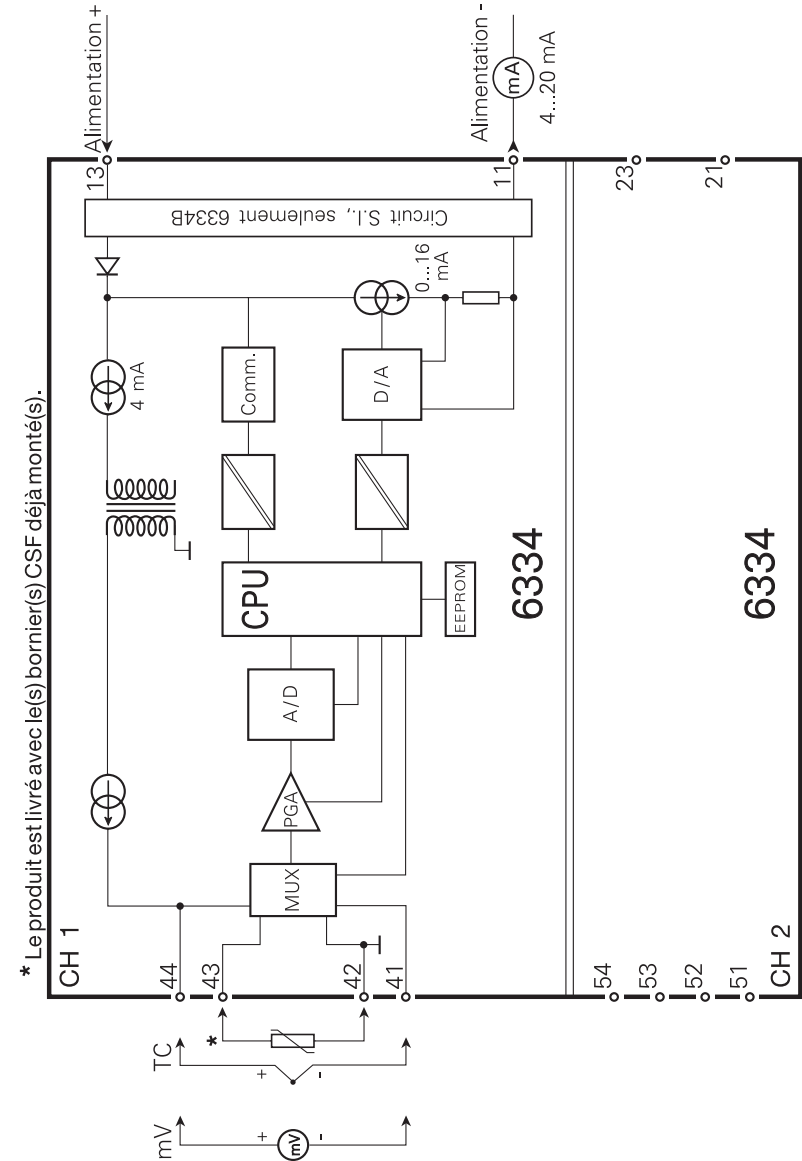

Programmation :

- Loop Link est un kit de programmation permettant de programmer le PReTrans 6334.
- Pour le raccordement du Loop Link, veuillez vous reporter au schéma ci-dessous et à l'aide en ligne du logiciel PReset.
- Lors de la communication avec des modules non-installés, les bornes 11, 12, 13 (voie 1) et 21, 22, 23 (voie 2) peuvent être démontés pour connecter le kit de programmation.
- Loop Link ne doit pas être utilisé pour communication avec des modules installés en zone dangereuse.

Numéro de référence : Loop Link

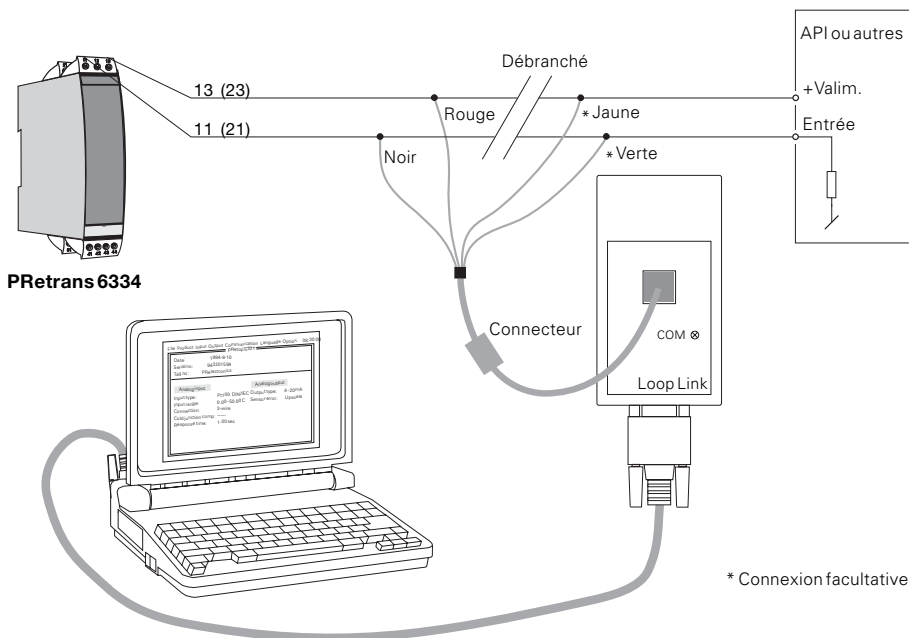

2-DRAHT PROGRAMMIERBARER MESSUMFORMER

PReTrans 6334

Inhaltsverzeichnis

Sicherheitsanweisung	38
EG-Konformitätserklärung.....	39
Verwendung.....	40
Technische Merkmale.....	40
Montage / Installation.....	40
Anwendungen	41
Bestellangaben.....	42
Elektrische Daten	42
Anschlüsse	46
Blockdiagramm	47
Programmierung.....	48

Sicherheitsanweisung

• Ex Installation:

Für sichere Installation von 6334B in explosionsgefährdeter Umgebung muss folgendes beobachtet werden. Die Installation muss nur von qualifizierten Personen, die mit den nationalen und internationalen Gesetze, Direktiven und Standards des Gebiets bekannt sind, vorgenommen werden.

Die Sensor Kreise sind von der Versorgung und dem Ausgang nicht vollkommen galvanisch getrennt. Die galvanische Isolierung ist so ausgelegt, dass sie eine Testspannung von 500 VAC für eine Minute aushält.

Für Applikationen in explosiver Atmosphäre aufgrund von Gasen oder Dämpfen und wo Kategorie 1G Geräte vorgeschrieben sind, muss die elektrostatische Ladung der Gehäuse der 2-Leiter Programmierbaren Messumformer vermieden werden.

Es ist weiterhin erforderlich, dass die Versorgungs- und Ausgangskreise (Klemmen 11...13 sowie 21...23) nicht mit der Masse verbunden werden.

EG-KONFORMITÄTSERKLÄRUNG

Als Hersteller bescheinigt

PR electronics A/S
Lerbakken 10
DK-8410 Rønde

hiermit für das folgende Produkt:

Typ: 6334
Name: 2-Draht Programmierbarer Messumformer

die Konformität mit folgenden Richtlinien und Normen:

Die EMV Richtlinien 2004/108/EG und nachfolgende Änderungen

EN 61326-1 : 2006

Zur Spezifikation des zulässigen Erfüllungsgrades, siehe die Elektrische Daten des Moduls.

Die ATEX Richtlinien 94/9/EG und nachfolgende Änderungen

EN 50014 : 1997 + A1, A2, EN 50020 : 2002 und
EN 50284 : 1999

ATEX-Zertifikat: KEMA 06ATEX0115 X (6334B)

Änderungen zur Einhaltung der folgenden Nachfolgenormen sind nicht erforderlich.

EN 60079-0 : 2006 und EN 60079-11 : 2007

Zulassungsstelle:

UL International Demko A/S
Lyskær 8
P.O. Box 514
2730 Herlev
Dänemark

Rønde, 17. April 2009



Peter Rasmussen
Unterschrift des Herstellers

2-DRAHT PROGRAMMIERBARER MESSUMFORMER PRetrans 6334

- *Eingang für TE*
- *Hohe Messgenauigkeit*
- *Galvanische Trennung*
- *Programmierbare Sensorfehlanzeige*
- *1- oder 2-kanalige Ausführung*

Verwendung:

- Linearisierte Temperaturmessung mit Thermoelementsensor.
- Verstärkung von bipolaren mV-Signalen, eventuell nach definierter Linearisierungsfunktion, zu einem 4...20 mA Signal linearisiert.

Technische Merkmale:

- PR6334 kann vom Benutzer innerhalb von wenigen Sekunden zur Messung in allen genormten TE-Temperaturbereiche programmiert werden.
- CJC-Vergleichsstellenkompensation mit montierten CJC-Anschlusssteckern.
- Das Ausgangssignal kann für eine Begrenzung programmiert werden.
- Die gespeicherten Daten werden laufend kontrolliert.

Montage / Installation:

- Wird vertikal oder horizontal auf DIN-Schiene montiert. Mit der Zweitkanalversion können 84 Kanäle pro Meter installiert werden.
- NB: Als Ex-Sicherheitsbarriere für 6334B empfehlen wir 5104B, 5114B oder 5116B.

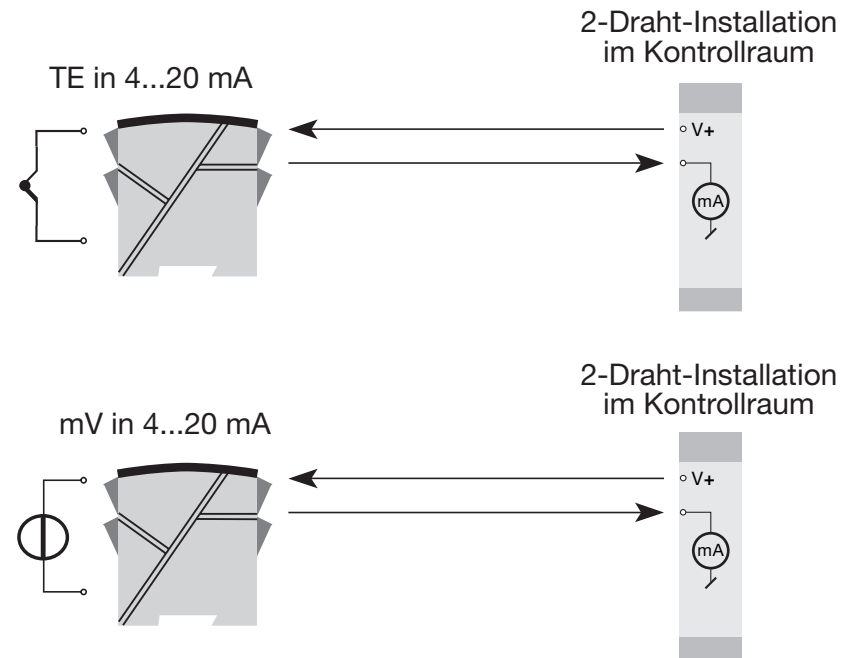

Bestellangaben: 6334

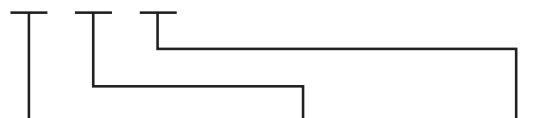

Typ	Version	Galvanische Trennung	Kanäle
6334	Standard : A ATEX Ex : B	1500 VAC : 2	Einkanalig : A Zweikanalig: B

Elektrische Daten:

Spezifikationsbereich:

-40°C bis +60°C

Allgemeine Daten:

Versorgungsspannung, DC

Standard 7,2...35 VDC

ATEX Ex..... 7,2...30 VDC

Eigenverbrauch, pro Kanal 0,17...0,8 W

Spannungsabfall..... 7,2 VDC

Isolationsspannung, Test / Betrieb..... 1,5 kVAC / 50 VAC

Isolationsspannung, Kanal 1 / Kanal 2:

Standard 3,75 kVAC

ATEX Ex..... 1500 VAC

Aufwärmzeit..... 5 Min.

Kommunikationsschnittstelle Loop Link

Signal- / Rauschverhältnis Min. 60 dB

Ansprechzeit (programmierbar)..... 1...60 s

EEProm Fehlerkontrolle..... < 3,5 s

Signaldynamik, Eingang..... 18 Bit

Signaldynamik, Ausgang..... 16 Bit

Kalibrierungstemperatur..... 20...28°C

Genauigkeit, höherer Wert von allgemeinen und Grundwerten:

Allgemeine Werte		
Eingangsart	Absolute Genauigkeit	Temperaturkoeffizient
Alle	≤ ±0,05% d. Messsp.	≤ ±0,01% d. Messsp / °C

Grundwerte		
Eingangsart	Grundgenauigkeit	Temperaturkoeffizient
Volt	≤ ±10 µV	≤ ±1 µV/°C
TE-Typ: E, J, K, L, N, T, U	≤ ±1°C	≤ ±0,05°C/°C
TE-Typ: B, R, S, W3, W5, LR	≤ ±2°C	≤ ±0,2°C/°C

EMV-Immunitätswirkung	< ±0,5% d. Messsp.
Erweiterte EMV-Immunität:	
NAMUR NE 21, A Kriterium, Burst.....	< ±1% d. Messsp.

Einfluss von Änderung der

Versorgungsspannung..... < 0,005% d. Messsp / VDC

Max. Leitungsquerschnitt..... 1 x 1,5 mm² Litzen draht

Luftfeuchtigkeit..... < 95% RF (nicht kond.)

Maß 109 x 23,5 x 104 mm

Schutzart IP20

Gewicht (1 / 2 Kanäle)..... 145 / 185 g

Elektrische Daten, Eingänge:

Max. Nullpunktverschiebung (Offset)..... 50% des gewählten Max.-Wertes

TE-Eingänge:

Typ	Min. Temperatur	Max. Temperatur	Min. Spanne	Norm
B	+400°C	+1820°C	200°C	IEC584
E	-100°C	+1000°C	50°C	IEC584
J	-100°C	+1200°C	50°C	IEC584
K	-180°C	+1372°C	50°C	IEC584
L	-100°C	+900°C	50°C	DIN 43710
N	-180°C	+1300°C	100°C	IEC584
R	-50°C	+1760°C	200°C	IEC584
S	-50°C	+1760°C	200°C	IEC584
T	-200°C	+400°C	50°C	IEC584
U	-200°C	+600°C	75°C	DIN 43710
W3	0°C	+2300°C	200°C	ASTM E988-90
W5	0°C	+2300°C	200°C	ASTM E988-90
LR	-200°C	+800°C	50°C	GOST 3044-84

Vergleichstellenkompensation (CJC)..... < ±1,0°C
 Fühlerfehlererkennung..... Ja
 Fühlerfehlerstrom:
 Bei Erkennung Nom. 33 mA
 sonst..... 0 mA

Spannungseingänge:

Messbereich -12...150 mV
 Min. Messbereich (Spanne)..... 5 mV
 Eingangswiderstand..... 10 MΩ

Ausgänge:

Stromausgänge:

Signalbereich..... 4...20 mA
 Min. Signalbereich..... 16 mA
 Aktualisierungszeit 440 ms
 Ausgangssignal bei EEPROMfehler ≤ 3,5 mA
 Belastungswiderstand..... ≤ (U_{Vers.} - 7,2) / 0,023 [Ω]
 Belastungsstabilität..... < ±0,01% d. Messsp. / 100 Ω

Sensorfehlanzeige:

Programmierbar 3,5...23 mA
 NAMUR NE43 aufsteuernd 23 mA
 NAMUR NE43 zusteuernd 3,5 mA

EEx- / I.S.-Zulassung - 6334B:

KEMA 06ATEX0115 X.....  II 1 G
 EEx ia IIC T6...T5
 Max. Umgebungstemperatur T6: -40°C ≤ T_a ≤ 40°C
 T5: -40°C ≤ T_a ≤ 60°C
 Anwendungsbereich in zone..... 0, 1 oder 2

Ex- / I.S.-Daten:

Ausgang, Klemme 11...13, (21...23):
 U_i..... : 30 VDC
 I_i..... : 120 mADC
 P_i..... : 0,84 W
 L_i..... : 10 μH
 C_i..... : 1,0 nF

Eingang, Klemme 41...44, (51...54):
 U_o..... : 9,6 VDC
 I_o..... : 25 mADC
 P_o..... : 60 mW
 L_o..... : 33 mH
 C_o..... : 2,4 μF

GOST R Zulassung:

VNIIM & VNIIFTRI, Cert. no. Siehe www.preelectronics.de

Eingehaltene Richtlinien:

Norm:

EMV 2004/108/EG..... EN 61326-1
 ATEX 94/9/EG..... EN 50014, EN 50020 und EN 50284

d. Messspanne = der gewählten Messspanne

Anschlüsse:

Eingänge:

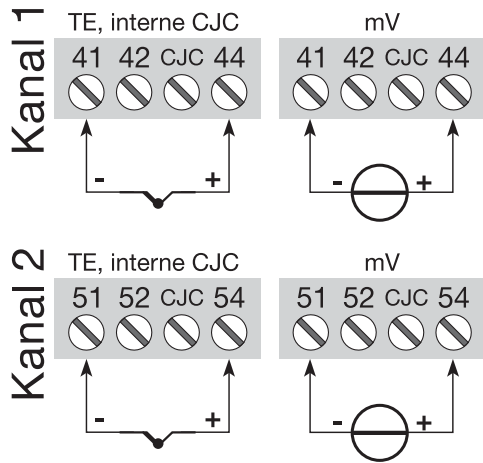

Ausgänge:

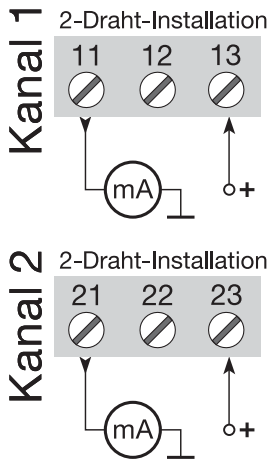

BLOCKDIAGRAMM:

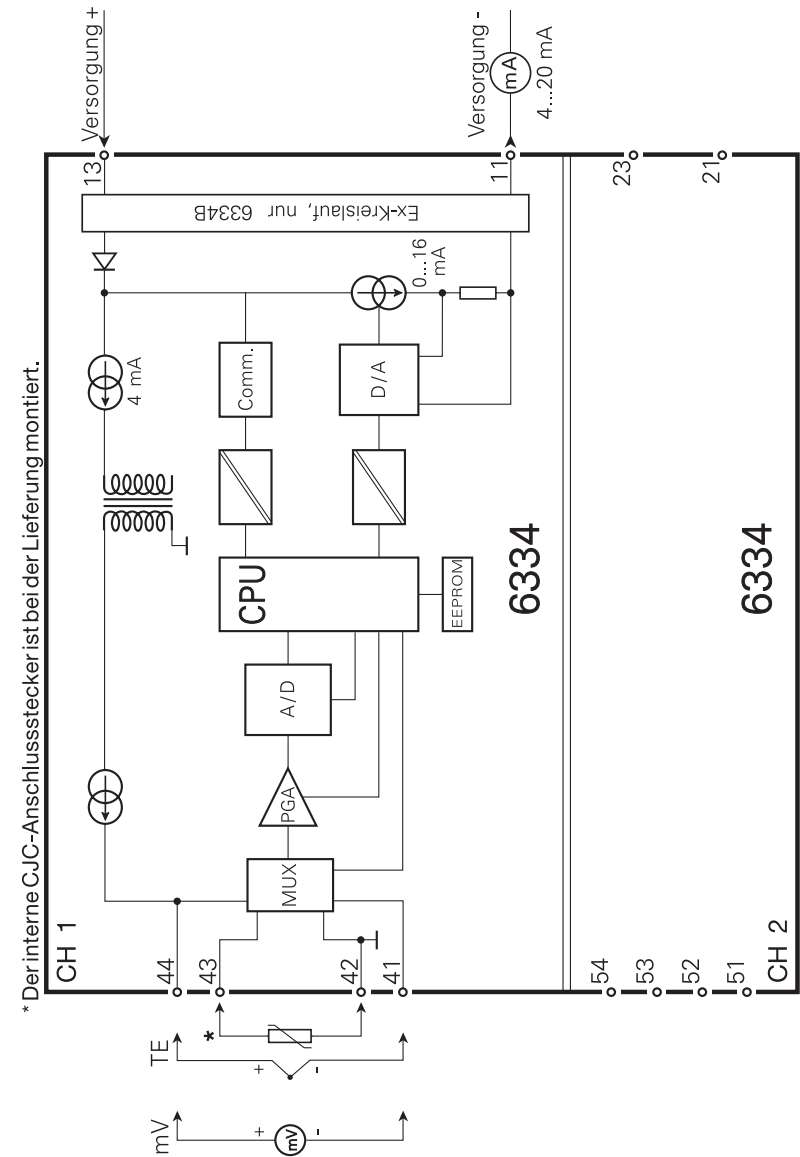

DK ▶ PR electronics A/S tilbyder et bredt program af analoge og digitale signalbehandlingsmoduler til industriel automation. Vores kompetenceområder omfatter: Isolation, Displays, Ex-interfaces, Temperatur samt Universal-moduler. Alle produkter opfylder de strengeste internationale standarder, og størstedelen integrerer den patenterede STREAM-SHIELD teknologi, der sikrer driftsikkerhed i selv de værste omgivelser. Vores motto »Signals the Best« er indbegrebet af denne filosofi – og din garanti for kvalitet.

UK ▶ PR electronics A/S offers a wide range of analogue and digital signal conditioning modules for industrial automation. Our areas of competence include: Isolation, Displays, Ex interfaces, Temperature, and Universal Modules. All products comply with the most exacting international standards and the majority feature our patented STREAM-SHIELD technology ensuring reliability in even the worst of conditions. »Signals the Best« is the epitome of our philosophy – and your guarantee for quality.

FR ▶ PR electronics A/S offre une large gamme de produits pour le traitement des signaux analogiques et numériques dans tous les domaines industriels. Nos compétences s'étendent des transmetteurs de température aux afficheurs, des isolateurs aux interfaces SI, jusqu'aux modules universels. Tous nos produits sont conformes aux normes internationales les plus strictes et la majorité d'entre eux répondent même à la technologie brevetée STREAM-SHIELD qui garantie un fonctionnement fiable sous les conditions les plus défavorables. Notre devise »SIGNALS the BEST« c'est notre ligne de conduite - et pour vous l'assurance de la meilleure qualité.

DE ▶ PR electronics A/S verfügt über ein breites Produktprogramm an analogen und digitalen Signalverarbeitungsmodulen für die industrielle Automatisierung. Unsere Kompetenzbereiche umfassen: Displays, Temperaturtransmitter, Ex- und galvanische Signaltrenner, und Universalgeräte. Alle Produkte von PR electronics werden in Übereinstimmung mit den strengsten internationalen Normen produziert. Für die Mehrzahl aller Produkte garantiert die patentierte STREAM-SHIELD Technologie höchste Zuverlässigkeit auch unter schwierigsten Einsatzbedingungen. »Signals the Best« ist Ihre Garantie für Qualität!

Subsidiaries

France
PR electronics Sarl
Zac du Chêne, Activillage
4, allée des Sorbiers
F-69673 Bron Cedex
sales@preelectronics.fr
tel. +33 (0) 4 72 14 06 07
fax +33 (0) 4 72 37 88 20

Germany
PR electronics GmbH
Bamlerstraße 92
D-45141 Essen
sales@preelectronics.de
tel. +49 (0) 201 860 6660
fax +49 (0) 201 860 6666

Italy
PR electronics S.r.l.
Via Giulietti, 8
IT-20132 Milano
sales@preelectronics.it
tel. +39 02 2630 6259
fax +39 02 2630 6283

Spain
PR electronics S.L.
Avda. Meridiana 354, 9^a B
E-08027 Barcelona
sales@preelectronics.es
tel. +34 93 311 01 67
fax +34 93 311 08 17

Sweden
PR electronics AB
August Barks gata 6A
S-421 32 Västra Frölunda
sales@preelectronics.se
tel. +46 (0) 3149 9990
fax +46 (0) 3149 1590

UK
PR electronics UK Ltd
Middle Barn, Apuldram
Chichester
West Sussex, PO20 7FD
sales@preelectronics.co.uk
tel. +44 (0) 1243 776 450
fax +44 (0) 1243 774 065

USA
PR electronics Inc
11225 West Bernardo Court
Suite A
San Diego, California 92127
sales@preelectronics.com
tel. +1 858 521 0167
fax +1 858 521 0945

Head office

Denmark
PR electronics A/S
Lerbakken 10
DK-8410 Rønne
www.preelectronics.com
sales@preelectronics.dk
tel. +45 86 37 26 77
fax +45 86 37 30 85



QUALITY SYSTEM AND ENVIRONMENTAL MANAGEMENT SYSTEM
DS/EN ISO 9001
DS/EN ISO 14001

