

PERFORMANCE
MADE
SMARTER

产品手册

6437

二线制 HART 7 温度变送器

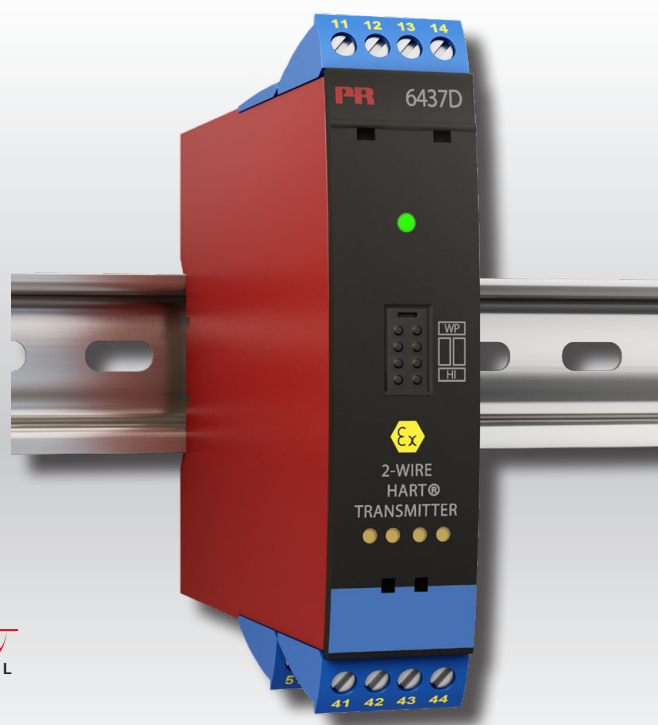

HART
COMMUNICATION PROTOCOL



温度

安全栅

通讯接口

多功能

隔离器

数显表

No. 6437V104-CN

产品版本: 01.00.00-01.99.99

PR
electronics

6 大特色产品

满足您的一切需求

单品出色·组合无敌

凭借创新型专利技术·信号调节更加简单·智能·产品组合由六大产品类组成·具备多种模拟量和数字量模块·涵盖上千种工业自动化应用·所有产品都符合甚至高于行业的最高标准·这可确保产品即便在最恶劣的环境条件下仍能可靠运行·5 年产品保修期·让您使用更安心·



Temperature

温度变送器和温度传感器系列产品·提供从温度测量点到系统控制一站式信号解决方案·从而在最大程度上保证信号的完整性·仅需一套点对点解决方案·您就可以在任何环境中将工业过程中的温度信号转换为模拟量信号·总线信号或数字通讯信号·该方案具备响应时间短·自动校准·传感器故障检测·低漂移和卓越 EMC 性能等诸多优点·



I.S. Interface

我们采用最严格的安全标准来检验产品·以期提供最安全的信号·秉承创新精神·我们已经在 SIL 2 全面评估本质安全型接口方面取得了开创性成就·其既高效又经济·效果卓著·成效斐然·模拟量和数字量本质安全栅种类齐全·同时提供多种输入输出·这使得 PR 标准成为一项易于实施的现场检验标准·在大型项目安装过程中·新背板方案大大简化安装和布线·且能与标准 DCS 系统无缝集成·



Communication

我们提供经济实惠·使用方便·面向未来的通讯接口·以便您能够访问所安装的 PR 产品·所有接口均可拆卸·并带有屏幕和按钮·可以显示过程值/诊断值和对参数进行配置·产品特定功能包括通过 Modbus 和蓝牙进行通讯·以及使用我们的 PR 过程主管 (PPS) 应用程序进行远程访问·适用于 iOS 和 Android 等终端·



Multifunction

单品为多功能系列产品·可涵盖大量现场应用·可轻而易举按照您的现场标准进行配置·此种单品可适用多种应用方式·既节省安装和培训时间·又大大简化库存备件管理·该设备专为长期信号精度高·功耗低·抗电噪声优异·编程简单而设计·



Isolation

基于微处理器技术研发的 6 mm 隔离器·小巧精致·响应迅速·品质一流·以极低的总拥有成本为专用应用提供卓越性能和抗电磁干扰·可水平或垂直安装·装置间无需间隙·



Display

数显表系列以其灵活性和稳定性著称·该设备系列几乎满足过程信号读数显示的所有需求·并具有通用的输入和供电能力·无论哪种行业·无论环境条件何其苛刻·该设备均能实时测量过程值并提供用户友好型界面和值得信赖的继电器信号·

二线制 HART 7 温度变送器 6437

目录

应用.....	4
技术特点.....	4
安装调试/编程.....	4
应用.....	5
订购.....	6
附件.....	6
电气规格.....	6
LED 功能.....	15
跳线.....	15
测试引脚.....	16
HART 命令.....	16
高级功能.....	17
动态变量映射.....	18
设备变量概述.....	18
软件写保护.....	19
跳线写保护.....	19
更改 HART 协议版本.....	19
SIL 功能.....	21
连接.....	22
方框图.....	23
设置参数.....	25
变送器多点模式连接.....	26
ATEX 安装图.....	27
IECEx Installation Drawing.....	33
CSA Installation Drawing.....	39
FM Installation Drawing.....	46
Instalação INMETRO.....	51
Appendix A: Diagnostics overview.....	57
文档更新记录.....	60

二线制 HART 7 温度变送器 6437

- RTD、TC、电位器、线性电阻和双极性 mV 输入
- 单路或双路传感器输入，具备传感器冗余和漂移检测功能
- 适宜工作的环境温度范围大：-50 到 +85°C
- 总精度达 0.014%
- 2.5 kVAC 电气隔离性能
- 符合 IEC61508:2010 的全面评估，适用于 SIL 2/3 应用

应用

- 测量各类 TC 和 RTD 温度输入类型。
- 转换大跨度线性电阻和电位器输入为 4...20 mA。
- 转换双极性 mV 信号为 4...20 mA。
- 整合入资产管理计划。
- 需要高精度和/或传感器冗余和漂移检测的关键应用。

技术特点

- 真正的双输入变送器，可接受最广泛的双输入组合。
- 传感器冗余 - 在主传感器故障的情况下，输出自动切换到备份传感器，保证过程正常运行。
- 传感器漂移检测 - 当传感器差异超过用户定义限制时进行报警，增强维护优化。
- 过程数据的动态变量映射，例如双输入功能的均值、差值，以及最小 / 最大值追踪。
- 全量程输入范围和环境条件下的，突破性的数字和模拟信号精度。
- 广泛的传感器匹配，包括 Callendar Van Dusen 和自定义线性化表。
- 可设定的输入限值配合运行时间统计，确保最大的过程可追溯性和传感器超范围保护。
- 符合 IEC 61508:2010 标准最高至 SIL 3 的全面评估，以及符合 IEC 61236-3-1 标准的增强 EMC 功能安全测试。
- 6437xxSx 的故障率对应于 ISO-13849 的性能级别“d”。
- 符合 NAMUR NE21、NE43、NE44、NE89 和 NE107 标准诊断信息。

安装调试/编程

- 每米 DIN 导轨可以实现多达 84 个输入。
- 使用 PR5909 Loop Link / HART 调制解调器通过 PRESET 软件进行配置，或者通过资产管理工具（例如 Pactware、AMS、HART 通讯器）进行配置，产品具备所有相关的 DD、eDD 和 DTM 文件。
- 6437A 可以安装于 zone 2 和 zone 22 / Class I, Division 2, Groups A, B, C, D 区域。
- 6437D 可以安装于 zone 0, 1, 2 和 zone 21, 22 以及 M1 / Class I, Division 1, Groups A, B, C, D 区域。

应用

双输入

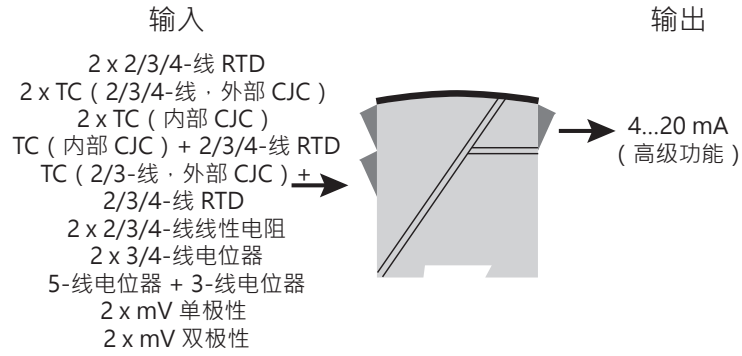

单输入

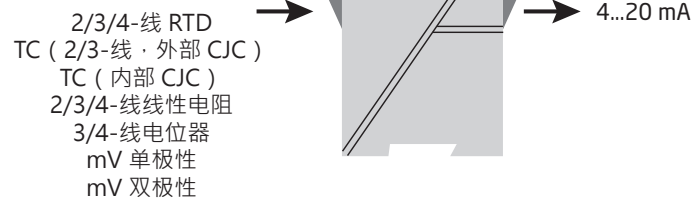

订购

型号	版本	输入	SIL 认证	船舶认证
6437	一般用途 : A	单输入 (4 端子) : 1	SIL : S	是 : M
	危险区域 : D	双输入 (8 端子) : 2	No SIL : -	否 : -

附件

5909	=	USB 接口回路通讯器和 Preset 软件
277	=	USB 接口 HART 调制解调器
1125	=	认可的校准证书 · 单路输入 · 3 点
1126	=	认可的校准证书 · 双路输入 · 3 点
1127	=	认可的校准证书 · 单路输入 · 5 点
1128	=	认可的校准证书 · 双路输入 · 5 点

电气规格

环境条件:

工作环境温度范围:

标准	-50°C 至 +85°C
SIL	-40°C 至 +80°C
存储温度	-50°C 至 +85°C
标定温度	23...25°C
湿度	< 99% RH (无冷凝)
防护等级	IP20

机械规格:

结构尺寸 (高x宽x深)	109 x 23.5 x 104 mm
重量 · 单 / 双通道版本 / 双通道	150 g / 160 g / 185 g
导线最大规格	0.13...2.08 mm ² / AWG 26...14 绞线
螺丝端子力矩	0,5 Nm
抗振规格	IEC 60068-2-6
2...25 Hz	±1.6 mm
25...100 Hz	±4 g

常用规格:

电源电压 · DC

6437A	7.5*...48** VDC
6437D	7.5*...30** VDC
6437, EU-RO	8.3...33.6 VDC ±10%
使用测试端子时额外所需电源电压	0.8 V
内部功耗 (最大)	≤ 850 mW 单个通道
最小负载电阻 (供电 > 37 V 时)	(电源电压 - 37) / 23 mA
隔离电压 · 测试/工作:		
6437A	2.5 kVAC / 55 VAC
6437D	2.5 kVAC / 42 VAC
极性反接保护	所有输入和输出
写保护	跳线或软件
预热时间	< 5 分钟
启动时间	< 2.75 s
参数设置	Loop Link & HART
信噪比	> 60 dB
长期稳定性 · 优于	±0.05% 所设量程 / 年 ±0.18% 所设量程 / 5年

* 注意: 最小电源电压必须在 6437 的端子处测量, 即必须考虑所有外部压降。

** 注意: 请确保使用合适的电源模块或安装过压保护装置来保护设备免受过电压损坏。

响应时间	75 ms
可调阻尼	0..60 s
信号动态范围 · 输入	24 位
信号动态范围 · 输出	18 位
电源电压变化的影响	< 0.005% 所设量程 / VDC

输入精度：

基本精度		
输入类型	基本精度	温度系数*
Pt10	≤ ±0.8°C	≤ ±0.020°C / °C
Pt20	≤ ±0.4°C	≤ ±0.010°C / °C
Pt50	≤ ±0.16°C	≤ ±0.004°C / °C
Pt100	≤ ±0.04°C	≤ ±0.002°C / °C
Pt200	≤ ±0.08°C	≤ ±0.002°C / °C
Pt500	T _{max.} ≤ 180°C: ≤ ±0.08°C T _{max.} > 180°C: ≤ ±0.16°C	≤ ±0.002°C / °C
Pt1000	≤ ±0.08°C	≤ ±0.002°C / °C
Pt2000	T _{max.} ≤ 300°C: ≤ ±0.08°C T _{max.} > 300°C: ≤ ±0.4°C	≤ ±0.002°C / °C
Pt10000	≤ ±0.16°C	≤ ±0.002°C / °C
Pt x	邻近点的最高公差	邻近点的最高系数
Ni10	≤ ±1.6°C	≤ ± 0.020°C / °C
Ni20	≤ ±0.8°C	≤ ± 0.010°C / °C
Ni50	≤ ± 0.32°C	≤ ± 0.004°C / °C
Ni100	≤ ±0.16°C	≤ ± 0.002°C / °C
Ni120	≤ ±0.16°C	≤ ± 0.002°C / °C
Ni200	≤ ±0.16°C	≤ ± 0.002°C / °C
Ni500	≤ ±0.16°C	≤ ± 0.002°C / °C
Ni1000	≤ ±0.16°C	≤ ± 0.002°C / °C
Ni2000	≤ ±0.16°C	≤ ± 0.002°C / °C
Ni10000	≤ ±0.32°C	≤ ± 0.002°C / °C
Ni x	邻近点的最高公差	邻近点的最高系数
Cu5	≤ ±1.6°C	≤ ± 0.040°C / °C
Cu10	≤ ±0.8°C	≤ ± 0.020°C / °C
Cu20	≤ ± 0.4°C	≤ ± 0.010°C / °C
Cu50	≤ ± 0.16°C	≤ ± 0.004°C / °C
Cu100	≤ ±0.08°C	≤ ± 0.002°C / °C
Cu200	≤ ±0.08°C	≤ ± 0.002°C / °C
Cu500	≤ ±0.16°C	≤ ± 0.002°C / °C
Cu1000	≤ ±0.08°C	≤ ± 0.002°C / °C
Cu x	邻近点的最高公差	邻近点的最高系数

* 输入温度系数为列出的值或[0.002% 测量值] / °C · 以较大值为准。

基本精度		
输入类型	基本精度	温度系数*
线性电阻：0...400 Ω	≤ ±40 mΩ	≤ ±2mΩ / °C
线性电阻：0...100 kΩ	≤ ±4 Ω	≤ ±0.2Ω / °C
电位器：0...100%	<0.05%	<±0.005%
mV: -20...100 mV	≤ ±5 μV ≤ ± 0.01% 测量值**	≤ ±0.2 μV / °C
mV: -100...1700 mV	≤ ± 0.1mV ≤ ± 0.01% 测量值**	≤ ±36 μV / °C
mV: ±800 mV	≤ ± 0.1mV ≤ ± 0.01% 测量值**	≤ ±32 μV / °C
TC E	≤ ±0.2°C ≤ ± 0.01% 测量值**	≤ ±0.025°C / °C
TC J	≤ ±0.25°C ≤ ± 0.01% 测量值**	≤ ±0.025°C / °C
TJ K	≤ ±0.25°C ≤ ± 0.01% 测量值**	≤ ±0.025°C / °C
TC L	≤ ±0.35°C ≤ ± 0.01% 测量值**	≤ ±0.025°C / °C
TC N	≤ ±0.4°C ≤ ± 0.01% 测量值**	≤ ±0.025°C / °C
TC T	≤ ±0.25°C ≤ ± 0.01% 测量值**	≤ ±0.025°C / °C
TC U	<0°C: ≤ ±0.8°C ≤ ± 0.01% 测量值** ≥0°C: ≤ ±0.4°C ≤ ± 0.01% 测量值**	≤ ±0.025°C / °C
TC Lr	≤ ±0.2°C ≤ ± 0.01% 测量值**	≤ ±0.1°C / °C
TC R	<200°C: ≤ ±0.5°C ≤ ± 0.01% 测量值** ≥200°C: ≤ ±1.0°C ≤ ± 0.01% 测量值**	≤ ±0.1°C / °C
TC S	<200°C: ≤ ±0.5°C ≤ ± 0.01% 测量值** ≥200°C: ≤ ±1.0°C ≤ ± 0.01% 测量值**	≤ ±0.1°C / °C
TC W3	≤ ±0.6°C ≤ ± 0.01% 测量值**	≤ ±0.1°C / °C
TC W5	≤ ±0.4°C ≤ ± 0.01% 测量值**	≤ ±0.1°C / °C

* 输入温度系数为列出的值或[0.002% 测量值] / °C·以较大值为准。

** 增益偏差。

基本精度		
输入类型	基本精度	温度系数*
TC 型号: B ¹	≤ ±1°C ≤ ± 0.01% 测量值**	≤ ±0.1°C / °C
TC 型号: B ²	≤ ±3°C ≤ ± 0.01% 测量值**	≤ ±0.1°C / °C
TC 型号: B ³	≤ ±8°C ≤ ± 0.01% 测量值**	≤ ±0.8°C / °C
TC 型号: B ⁴	未指定	未指定
CJC (内部)	< ±0.5°C	包含在基本精度内
CJC (外部)	≤ ±0.08°C	≤ ±0.002°C / °C

* 输入温度系数为列出的值或[0.002% 测量值] / °C·以较大值为准。

** 增益偏差。

TC B¹ 精度规格适用范围. > 400°C

TC B² 精度规格适用范围. > 160°C < 400°C

TC B³ 精度规格适用范围. > 85°C < 160°C

TC B⁴ 精度规格适用范围. < 85°C

输出精度：

基本精度		
输出类型	基本精度	温度系数
均值	输入 1 和 2 的平均精度	输入 1 和 2 的平均温度系数
差值测量	输入 1 和 2 的精度和	输入 1 和 2 的温度系数和
模拟量输出	≤ ±1.6μA (满量程的 0.01%)	≤ ±0.48μA / K (≤ ±0.003% 满量程 / K)

精度计算举例：

示例：Pt100 传感器，配置为 -200°C 至 + 850°C：

Pt100基本精度 = 0.04°C

输出模拟量精度 = 0.0016 mA

$$\text{总体精度 (mA)} = \frac{\text{基本精度}}{\text{设定量程输入}} \times 16.0 \text{ mA} + \text{输出模拟量精度}$$

$$\text{总体精度 (mA)} = \frac{0.04^\circ\text{C}}{850^\circ\text{C} - (-200^\circ\text{C})} \times 16.0 \text{ mA} + 0.0016 \text{ mA} = \underline{0.0022 \text{ mA}}$$

$$\text{总体精度 (\%)} = \frac{\text{总体精度 (mA)}}{16.0 \text{ mA}} \times 100\%$$

$$\text{总体精度 (\%)} = \frac{0.0022 \text{ mA}}{16.0 \text{ mA}} \times 100\% = \underline{0.01381\%}$$

示例：型号 K TC，内部 CJC，测量读数为400°C，量程为0 ... 400°C：

型号 K TC基本精度 = 0.25°C

输出模拟量精度 = 0.0016 mA

$$\text{总体精度 (mA)} = \frac{\text{基本精度} + \text{内部 CJC} + (\text{增益偏差} \times \text{测量读数})}{\text{设定量程输入}} \times 16.0 \text{ mA} + \text{输出模拟量精度}$$

$$\text{总体精度 (mA)} = \frac{0.25^\circ\text{C} + 0.5^\circ\text{C} + (0,0001 \times 400)}{400^\circ\text{C}} \times 16.0 \text{ mA} + 0.0016 \text{ mA} = \underline{0.0332 \text{ mA}}$$

$$\text{总体精度 (\%)} = \frac{\text{总体精度 (mA)}}{16.0 \text{ mA}} \times 100\%$$

$$\text{总体精度 (\%)} = \frac{0.0332 \text{ mA}}{16.0 \text{ mA}} \times 100\% = \underline{0.2075\%}$$

示例：型号 K TC，外部 CJC Pt1000，测量读数为400°C，量程为0 ... 400°C：

型号 K TC基本精度 = 0.25°C

输出模拟量精度 = 0.0016 mA

$$\text{总体精度 (mA)} = \frac{\text{基本精度} + \text{外部 CJC} + (\text{增益偏差} \times \text{测量读数})}{\text{设定量程输入}} \times 16.0 \text{ mA} + \text{输出模拟量精度}$$

$$\text{总体精度 (mA)} = \frac{0.25^\circ\text{C} + 0.08^\circ\text{C} + (0,0001 \times 400)}{400^\circ\text{C}} \times 16.0 \text{ mA} + 0.0016 \text{ mA} = \underline{0.0164 \text{ mA}}$$

$$\text{总体精度 (\%)} = \frac{\text{总体精度 (mA)}}{16.0 \text{ mA}} \times 100\%$$

$$\text{总体精度 (\%)} = \frac{0.0164 \text{ mA}}{16.0 \text{ mA}} \times 100\% = \underline{0.1025\%}$$

示例精度计算基于工厂校准环境温度，并且不考虑其他潜在的不准确来源，例如电源模块影响，环境温度波动等。

EMC – 电磁兼容对精度的影响	< ±0.1% 所设量程
扩展的 EMC 电磁兼容 :	
NAMUR NE 21, A criterion, burst.	< ±1% 所设量程

输入规格 :

RTD 输入类型 :

RTD 类型	标准	最小值	最大值	α	最小量程
Pt10...10.000	IEC 60751	-200°C	+850°C	0.003851	10°C
	JIS C 1604-8	-200°C	+649 °C	0.003916	10°C
	GOST 6651-2009	-200°C	+850°C	0.003910	10°C
	Callendar Van Dusen	-200°C	+850°C	-----	10°C
Ni10...10.000	DIN 43760-1987	-60°C	+250°C	0.006180	10°C
	GOST 6651-2009 / OIML R84:2003	-60°C	+180°C	0.006170	10°C
Cu5...1000	Edison Copper Winding No. 15	-200°C	+260°C	0.004270	100°C
	GOST 6651-2009 / OIML R84:2003	-180°C	+200°C	0.004280	100°C
	GOST 6651-94	-50°C	+200°C	0.004260	100°C

- 连接类型 2-, 3- 和 4-线
- 电缆电阻 (单根导线 ; 最大) 50 Ω
- 传感器电流 < 0.15 mA
- 传感器电缆电阻的影响 (3- / 4-线) < 0.002 Ω / Ω
- 传感器电缆 · 线-线电容 最大 30 nF (Pt1000 & Pt10000 IEC 和 JIS + Ni1000 & Ni10000)
最大 50 nF (以上其它)
- 传感器故障检测 · 可设置 无 · 短路 · 断线 · 短路或断线

 注意 : 无论传感器故障检测如何配置 , 如果配置的传感器类型的下限低于传感器短路检测常数限值 , 则将禁用传感器短路故障检测。

- 传感器短路检测限值 15 Ω
- 传感器故障检测时间 (RTD 元件) \leq 70 ms
- 传感器故障检测时间 (第 3 线和第 4 线) \leq 2000 ms

TC 输入类型 :

型号	最低温度	最高温度	最小量程	标准
B	0 (85)°C	+1820°C	100°C	IEC 60584-1
E	-200°C	+1000°C	50°C	IEC 60584-1
J	-100°C	+1200°C	50°C	IEC 60584-1
K	-180°C	+1372°C	50°C	IEC 60584-1
L	-200°C	+900°C	50°C	DIN 43710
Lr	-200°C	+800°C	50°C	GOST 3044-84
N	-180°C	+1300°C	50°C	IEC 60584-1
R	-50°C	+1760°C	100°C	IEC 60584-1
S	-50°C	+1760°C	100°C	IEC 60584-1
T	-200°C	+400°C	50°C	IEC 60584-1
U	-200°C	+600°C	50°C	DIN 43710
W3	0°C	+2300°C	100°C	ASTM E988-96
W5	0°C	+2300°C	100°C	ASTM E988-96

冷端补偿 (CJC) :

- 固定补偿 · 通过 Pt100 或 Ni100 传感器实现内部或外部补偿
- 内部 CJC 温度范围 -50°C 至 +100°C
- 外部 CJC 连接 2, 3 或 4-线 (4 线仅适用于双输入设备)
- 外部 CJC 电缆电阻 (单根导线 ; 3-线和 4-线连接) 50 Ω
- CJC 电缆电阻的影响 (3-线和 4-线连接) < 0.002 Ω / Ω
- 外部 CJC 传感器电流 < 0.15 mA

外部 CJC 温度范围	-50°C 至 +135°C
CJC 传感器电缆·线-线电容	最大 50 nF
最大总电缆电阻	最大 10 kΩ
传感器电缆·线-线电容	最大 50 nF
传感器故障检测·可设置	无·短路·断线·短路或断线



传感器短路检测仅适用于 CJC 传感器。

传感器故障检测时间 (TC 元件)	≤ 70 ms
传感器故障检测时间·外部 CJC (第 3 线和第 4 线)	≤ 2000 ms

线性电阻输入:

输入范围	0 Ω...100 kΩ
最小量程	25 Ω
连接类型	2-, 3- 或 4-线
电缆电阻 (单根导线; 最大)	50 Ω
传感器电流	< 0.15 mA
传感器电缆电阻的影响 (3- / 4-线)	< 0.002 Ω / Ω
传感器电缆·线-线电容	最大 30 nF (线性电阻 > 400 Ω) 最大 50 nF (线性电阻 ≤ 400 Ω)
传感器故障检测·可设置	无·断线

电位器输入:

电位器	10 Ω...100 kΩ
输入范围	0...100%
最小量程	10%
连接类型	3-, 4- 或 5-线 (5 线仅适用于双输入设备)
电缆电阻 (单根导线; 最大)	50 Ω
传感器电流	< 0.15 mA
传感器电缆电阻的影响 (4- / 5-线)	< 0.002 Ω / Ω
传感器电缆·线-线电容	最大 30 nF (电位器 > 400 Ω) 最大 50 nF (电位器 ≤ 400 Ω)
传感器故障检测·可设置	无·短路·断线·短路或断线



注意: 无论传感器故障检测如何配置, 如果配置的电位器阻值类型低于传感器短路检测常数限值, 则将禁用传感器短路故障检测。

传感器短路检测限值	15 Ω
传感器故障检测时间 (电位器检测臂)	≤ 70 ms (无传感器短路检测)
传感器故障检测时间·元件	≤ 2000 ms
传感器故障检测时间 (第 4 线和第 5 线)	≤ 2000 ms

mV 输入:

测量范围	-800...+800 mV (双极性) -100 至 1700 mV
最小量程	2.5 mV
输入电阻	10 MΩ
传感器电缆·线-线电容	最大 30 nF (输入范围: -100...1700 mV) 最大 50 nF (输入范围: -20...100 mV)
传感器故障检测·可设置	无·断线
传感器故障检测时间	≤ 70 ms

输出规格和 HART:

正常范围·可设定	3.8...20.5 / 20.5...3.8 mA
扩展范围 (输出限制)·可设定	3.5...23 / 23...3.5 mA
更新时间	10 ms
负载 (@ 电流输出)	≤ (V _{供电} - 7.5) / 0.023 [Ω]
负载稳定性	< 0.01% 所设量程 / 100 Ω

所设量程 = 当前设定的量程范围

输出负载：

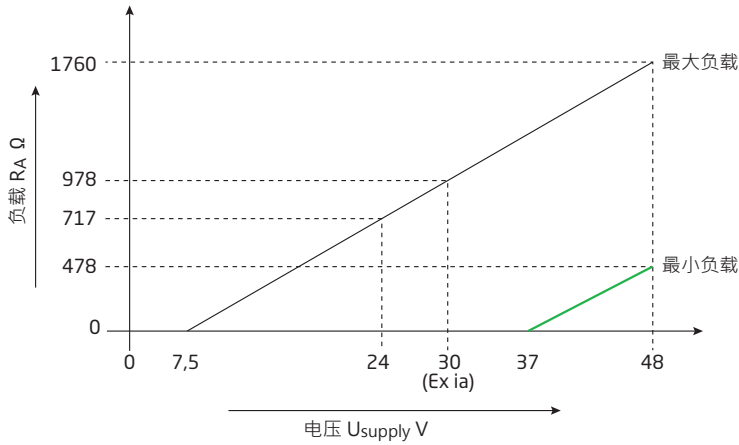

- 传感器故障指示·可设定 3.5...23 mA
(在选择 TC 和 mV 输入时不检测传感器短路报警)
- NAMUR NE43 Upscale > 21 mA
- NAMUR NE43 Downscale < 3.6 mA
- HART 协议修订版本 HART 7 和 HART 5

可设定输入 / 输出限制：

- 故障电流 启用 / 禁用
- 设置故障电流 3.5 mA...23 mA

可设定的传感器输入和电流输出限制可用于提高系统安全性和完整性。

输入：

当输入信号超过可设定的下限或上限时，设备将输出用户定义的故障电流。设置输入限制可确保任何超出范围的测量值都可以通过变送器输出进行唯一识别和标记，从而改进资产和材料保护，例如可以缓解反应过程的热失控。

示例：

- Pt100 输入范围 100°C 到 400°C
- 输入限制设置为上限 = +650°C, 下限 = -150°C
- 故障电流设置为 3.5 mA
- 输出限制设置为上限 = 20.5 mA, 下限 = 3.8 mA

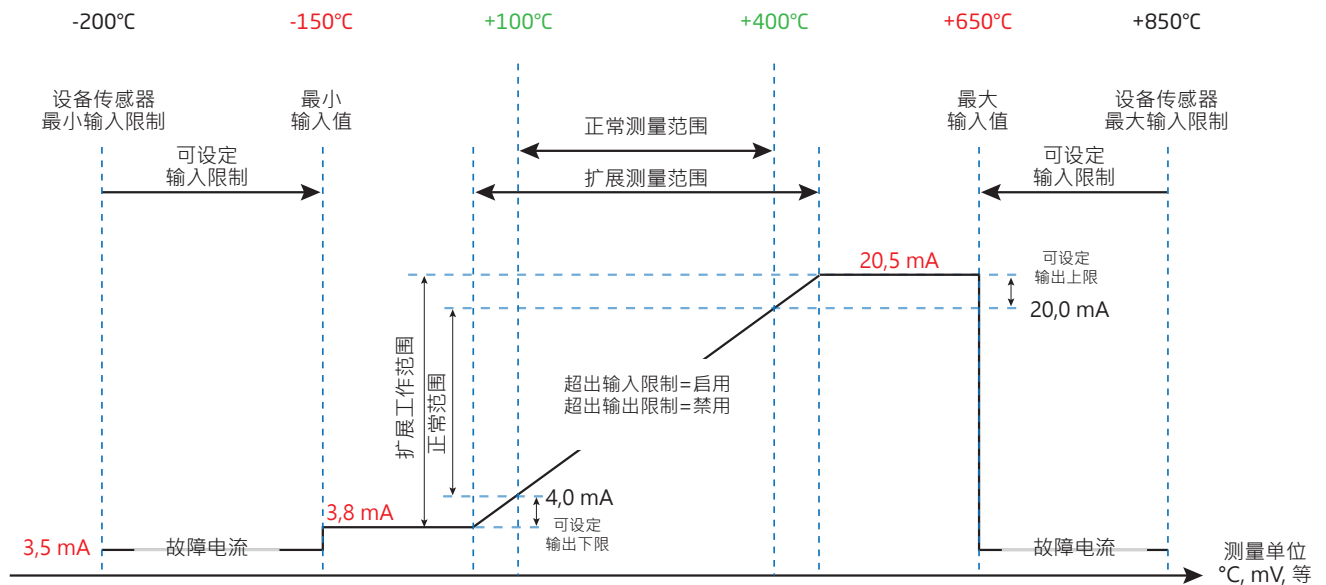

输出:

当电流输出超过可设定的上限或下限时，设备将输出用户定义的故障电流。

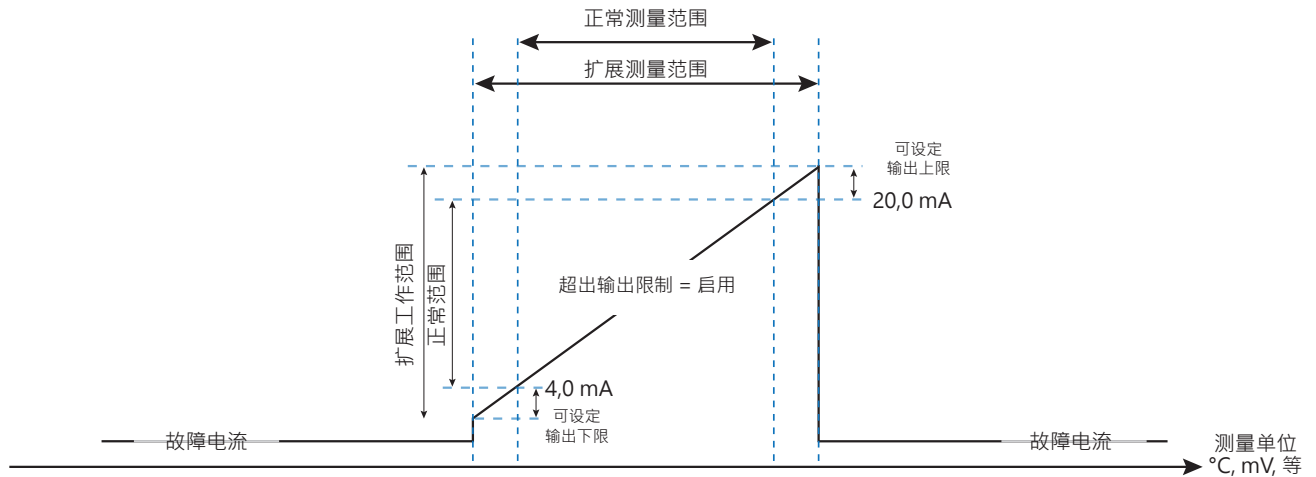

符合标准:

EMC	2014/30/EU & UK SI 2016/1091
ATEX	2014/34/EU & UK SI 2016/1107
RoHS	2011/65/EU & UK SI 2012/3032
EAC	TR-CU 020/2011
EAC Ex	TR-CU 012/2011

认证:

Ex / I.S.:

ATEX	
6437A	DEKRA 18ATEX0135X
6437D	DEKRA 16ATEX0047X
IECEX	IECEX DEK.16.0029X
c FM us	FM16CA0146X / FM16US0287X
c CSA us	16.70066266
INMETRO	DEKRA 23.0002X
NEPSI	GYJ23.1253X
EAC Ex	RU C-DK.PB98.V.00192

海洋船舶认证:

EU RO 互认型式认证	MRA0000023
--------------	------------

功能安全:

SIL2 认证 & 符合 IEC 61508 : 2010
SFF > 93% - 类型 B 组件
SIL3 适用于冗余结构 (HFT = 0; 1oo2)
FMEDA 报告下载 - www.prelectronics.com

LED 功能

产品 LED 根据 NAMUR NE44 和 NE107 指示故障状态。

状态	绿色 / 红色 LED
设备正常	常亮
无电源	关
指示与设备无关的故障·例如断线·传感器短路·超输入或输出限制等	闪烁 
设备故障	常亮

有关详细的设备诊断行为和 NE107 信息·请参阅第 57 页的附录 A。

跳线

6437 拥有两个面板前跳线 - 一个跳线用于启用写保护·另一个跳线用于选择安全状态下的输出电流到 21 mA 以上·如 NAMUR NE43 中规定的那样。

如果未插入跳线·则安全状态下的输出电流将低于 3.6 mA·如 NAMUR NE43 中规定的那样。

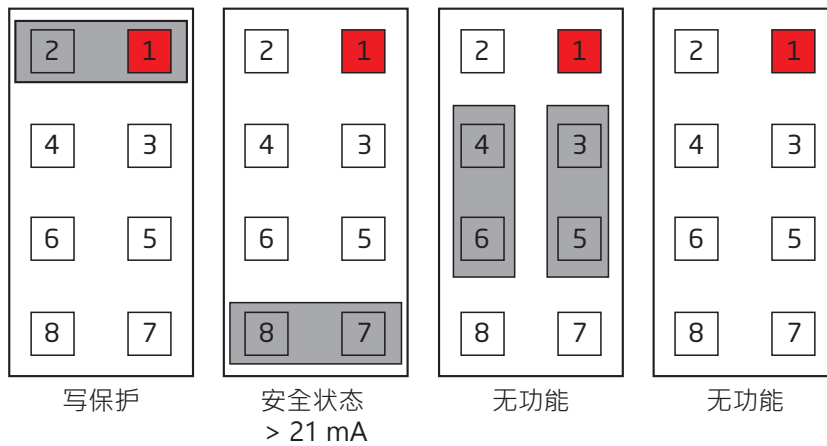

测试引脚

测试引脚可以直接测量回路电流，并同时保持工作回路不中断。使用测试引脚时，变送器必须连接电源。

警告！

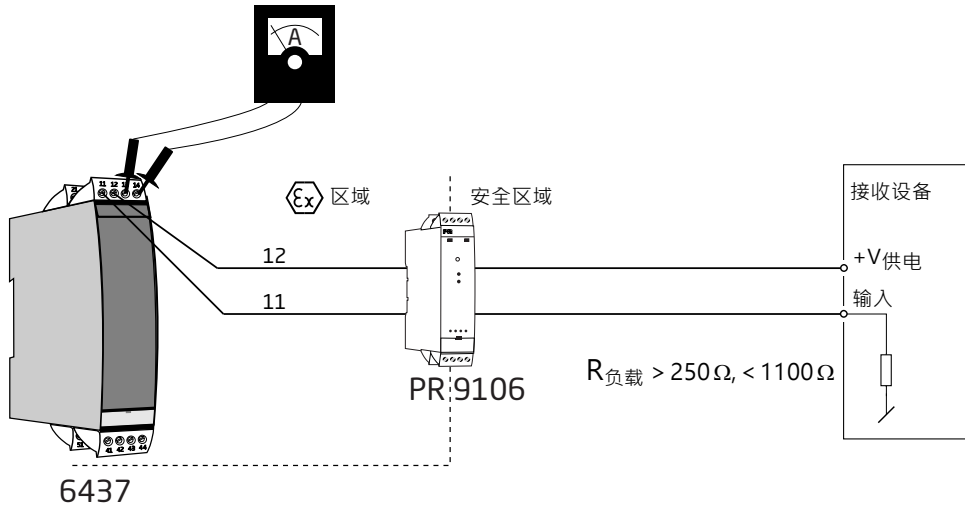

对于危险区域安装，只能使用经过认证的测试设备。

HART 命令

有关 6437 HART 命令的定义和更多信息，请参阅现场设备规范。

高级功能

功能	说明									
差值	模拟量输出信号与输入 1 和输入 2 之间的差值成比例。 模拟量输出 = 输入 1 - 输入 2 或输入 2 - 输入 1 或 输入 2 - 输入 1									
均值	模拟量输出信号与输入 1 和输入 2 测量的平均值成比例。 模拟量输出 = 0.5 * (输入 1 + 输入 2)									
最大值	模拟量输出与具有最高值的输入成比例。 如果 (输入 1 > 输入 2) 则 模拟量输出 = 输入 1 否则 模拟量输出 = 输入 2									
最小值	模拟量输出与具有最低值的输入成比例。 如果 (输入 1 > 输入 2) 则模拟量输出 = 输入 1 否则 模拟量输出 = 输入 2									
传感器漂移	如果输入 1 和输入 2 之间的测量值差值超过预定义的极限值, 则会指示传感器漂移故障。 如果 ABS (输入 1 - 输入 2) > 传感器漂移限制 则 指示传感器漂移故障									
冗余 (热备份)	只要未检测到故障并且输入未超出用户定义限值, 模拟量输出与输入 1 成比例。如果检测到输入 1 故障或传感器 1 的值超出用户定义限值, 则模拟量输出就自动切换到与输入 2 成比例, 并生成一条警告指示。 如果 (输入 1 无传感器故障 以及 输入 1 无内部超限报警) 则 模拟量输出 = 输入 1 否则如果 (输入 2 无传感器故障 和 输入 2 无内部超限报警) 则 模拟量输出 = 输入 2									
自定义线性化 - 多项式类型	支持最多 5 段多项式线性化, 每段支持高达 4 阶多项式。									
自定义线性化 - Callendar Van Dusen	支持直接输入 CVD 常数。									
自定义线性化 - 线性化表	支持多达 60 个输入 / 输出对应值的线性化表格。									
定制线性化 - 二次样条线性化	支持多达 40 个输出值的二次样条线性化。									
运行时间统计 - 变送器电路	统计记录变送器运行期间其内部温度和相变时间, 数据通过 9 个固定温度区间记录。 <table border="1" style="margin-left: 20px;"> <tr><td>< -50°C</td></tr> <tr><td>-50...-30°C</td></tr> <tr><td>-30...-10°C</td></tr> <tr><td>-10...+10°C</td></tr> <tr><td>+10...+30°C</td></tr> <tr><td>+30...+50°C</td></tr> <tr><td>+50...+70°C</td></tr> <tr><td>+70...+85°C</td></tr> <tr><td>>85°C</td></tr> </table>	< -50°C	-50...-30°C	-30...-10°C	-10...+10°C	+10...+30°C	+30...+50°C	+50...+70°C	+70...+85°C	>85°C
< -50°C										
-50...-30°C										
-30...-10°C										
-10...+10°C										
+10...+30°C										
+30...+50°C										
+50...+70°C										
+70...+85°C										
>85°C										
运行时间统计 - 输入	记录设备运行过程中的输入测量值, 数据以时间统计的方式分类记录在 9 个固定输入子区间内。 每种输入类型有单独定义子范围。									
从指针 - 变送器电路	记录变送器完整生命周期内最小 / 最大内部温度值。									
从指针 - 输入	记录最小 / 最大输入测量值。 当测量配置更改时, 此值会被重置。									

动态变量映射

支持四个动态变量 PV·SV·TV 和 QV。

使用 HART 命令，可以任意组合分配给任何设备变量 (DV 0 - 15)。

映射到 PV 的设备变量控制着回路电流。

设备变量	
DV0	输入 1 (温度·电压·电阻...)
DV1	输入 2 (温度·电压·电阻...)
DV2	CJC 1·输入 1 CJC 温度·只有输入 1 是 TC 输入时有效
DV3	CJC 2·输入 2 CJC 温度·只有输入 2 是 TC 输入时有效
DV4	均值 (输入 1 和 输入 2)
DV5	差值 (输入 1 - 输入 2)
DV6	差值 (输入 2 - 输入 1)
DV7	差值绝对值 (输入 1 - 输入 2)
DV8	最小值 (输入 1·输入 2)
DV9	最大值 (输入 1·输入 2)
DV10	输入 1 带输入 2 作为备份
DV11	输入 2 带输入 1 作为备份
DV12	均值带输入 1 或 2 作为备份
DV13	最小值带输入 1 或 2 作为备份
DV14	最大值带输入 1 或 2 作为备份
DV15	电路温度

设备变量概述

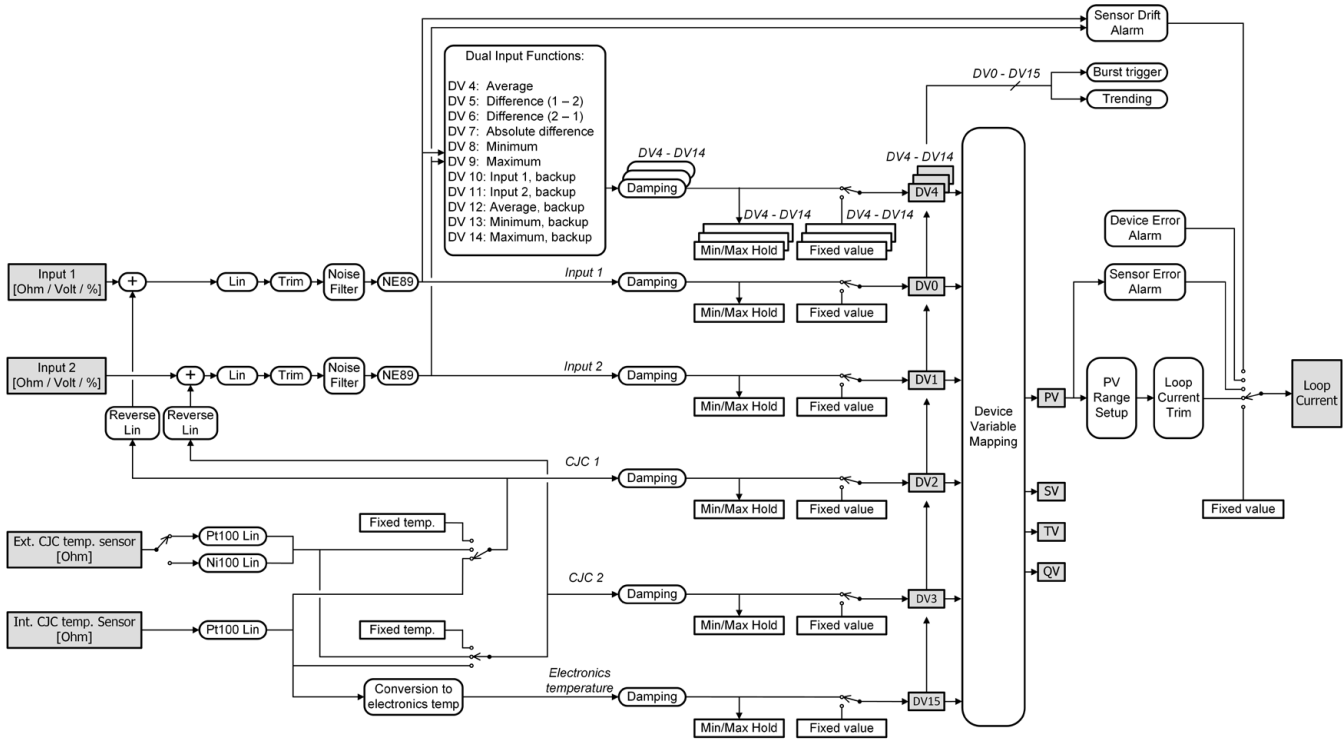

软件写保护

设备离开工厂时的默认密码为“*****”；该值用户可以更改。

如果忘记了当初当前密码，请联系 PR electronics 支持人员 - www.prelectronics.com/cn/contact。
更改密码时，只能使用可以输入和显示在任何终端的 Latin-1 字符。

当启用写保护时，无论“写保护”硬件跳线位置如何，都不会接受“写入”命令。

跳线写保护

如果硬件跳线设置在“写保护”位置，则无论是否被软件禁用，都不会接受“写入”命令。

更改 HART 协议版本

可以使用 PReset 软件和 PR 5909 回路通讯器或 HART 接口来更改本机的 HART 协议版本。
还可以使用其他 HART 配置工具，如手持式 HART 终端。

使用 HART 手持终端将 6437 从 HART 7 更改为 HART 5 的步骤，反之亦然：

将 6437 从 HART 7 更改为 HART 5：

1. 进入设备菜单 (或按 home 键) 后，显示在线菜单
2. 选择**设备设置**并按向右箭头键 (或直接按数字 7 键)
3. 选择**诊断 / 服务**，然后按向右箭头键 (或直接按数字 3 键)
4. 选择**写保护**，然后按向右箭头键 (或直接按数字 6 键)
5. 选择**更改为 HART 5**，然后按向右箭头键 (或直接按数字 3 键)
6. 当显示屏显示“您确定要将协议更改为 HART 5?”时，按 OK
7. 输入正确的活动密码，默认为“*****” (八颗星)，然后按 OK
8. 当显示器显示“设备现在处于 HART 5 模式”时，按 OK，然后退出，进入离线模式，并重新扫描新设备。
9. 设备现在将显示为 6437 (HART5) 设备，选择它，并再次进入在线菜单

注意！更改为 HART 5 后，配置将重置为出厂默认值。

在线菜单中的快捷键顺序为：7, 3, 6, 3, OK, OK, OK, Exit。

要将设备更改回 HART 7，请按照与上述相同的步骤进行操作，但必须在步骤 5 中选择**更换为 HART 7**。

但改回 HART 7 时，配置保持不变。

使用 PReset 软件和 5909 Loop Link 或 HART 通讯接口端将 6437 从 HART 7 更改为 HART 5 的步骤，反之亦然：

从 HART 7 切换到 HART 5

选择 6437 产品，然后单击“HART”选项卡。

单击“设备密码 / 写保护 / 协议...” ，在弹出的窗口中选择“更改协议到 HART 5” ，然后按 OK 确认。

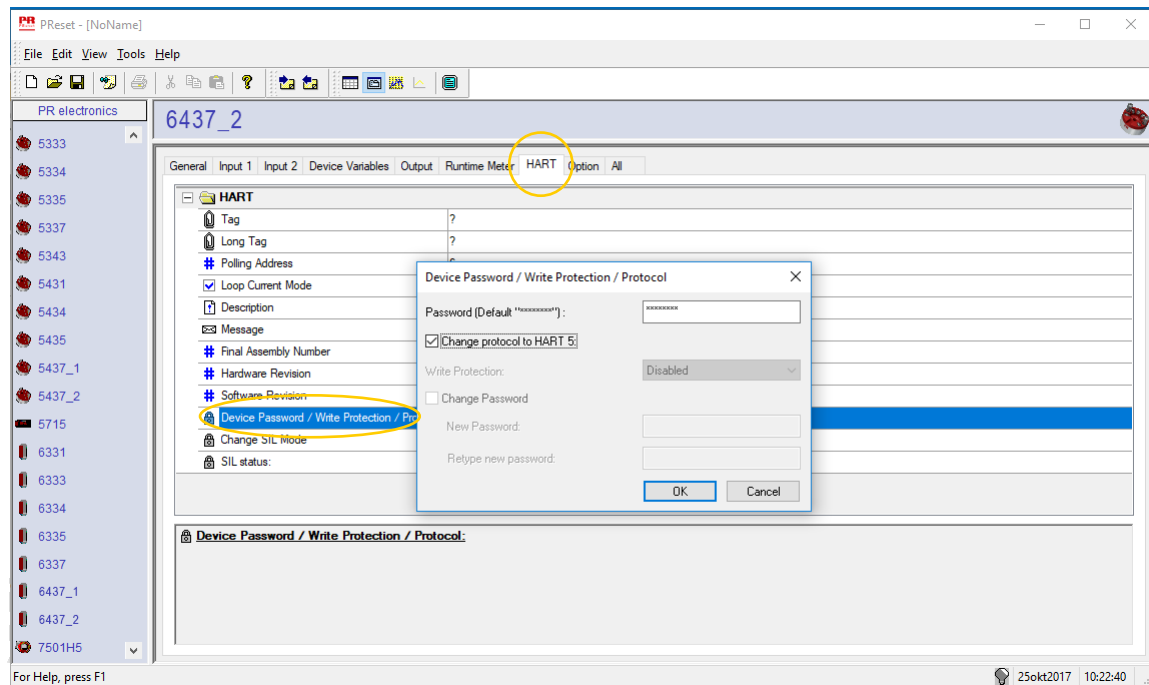

然后将出现以下消息：

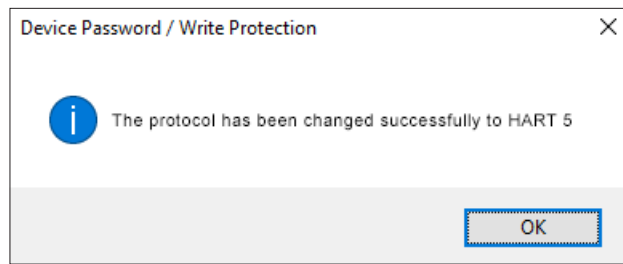

注意！更改为 HART 5 后，配置将重置为出厂默认值。

从 HART 5 切换到 HART 7

选择 6437 产品，然后单击“HART”选项卡。

单击“设备密码 / 写保护 / 协议...” ，在弹出的窗口中选择“更改协议到 HART 7” ，然后按 OK 确认。

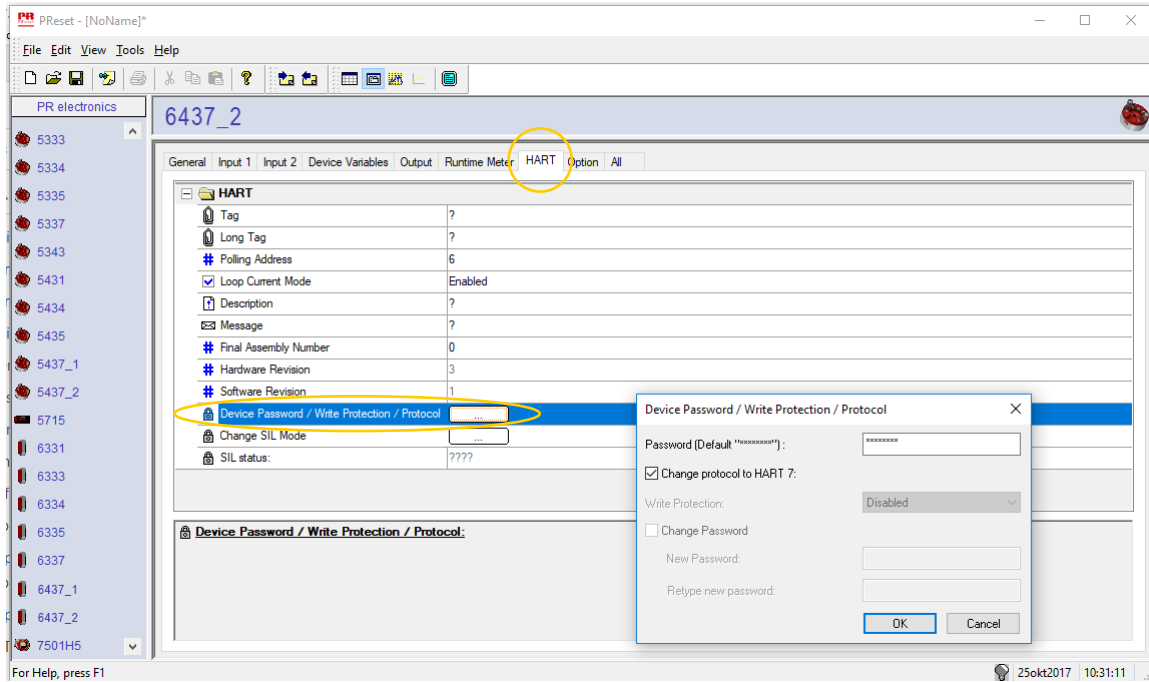

然后将出现以下消息：

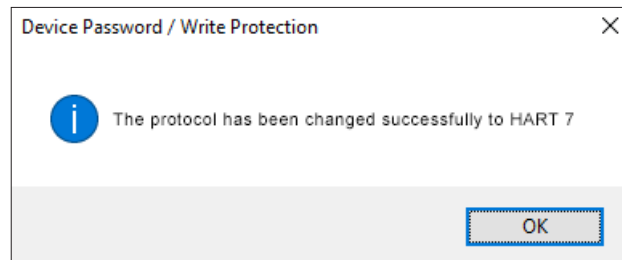

SIL 功能

有关如何在 6437 上启用 SIL 模式的说明和进一步信息，请参阅“安全手册”。

连接

单输入：

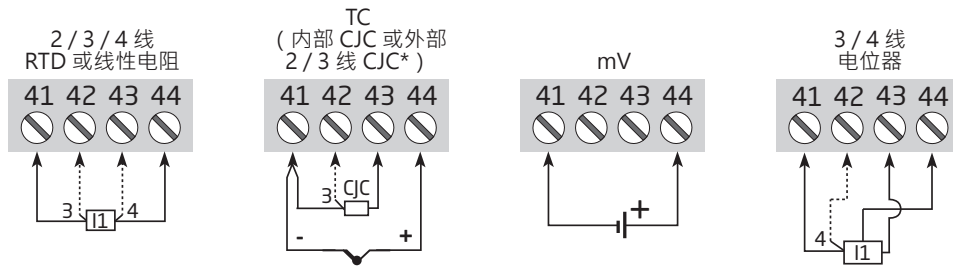

双输入：

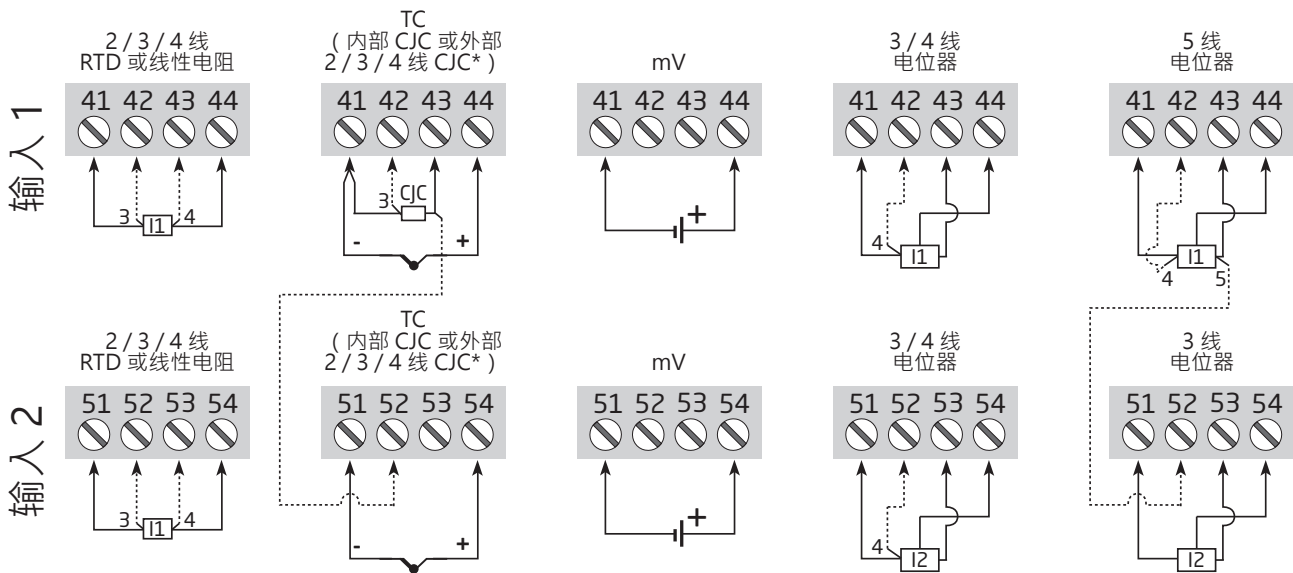

* 当使用热电偶输入时，6437 配置后可通过 Pt100 或 Ni100 传感器实现内部或外部的固定补偿。设备配置期间必须选择此操作。

输出：

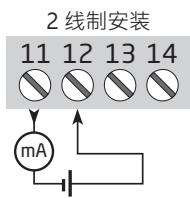

方框图

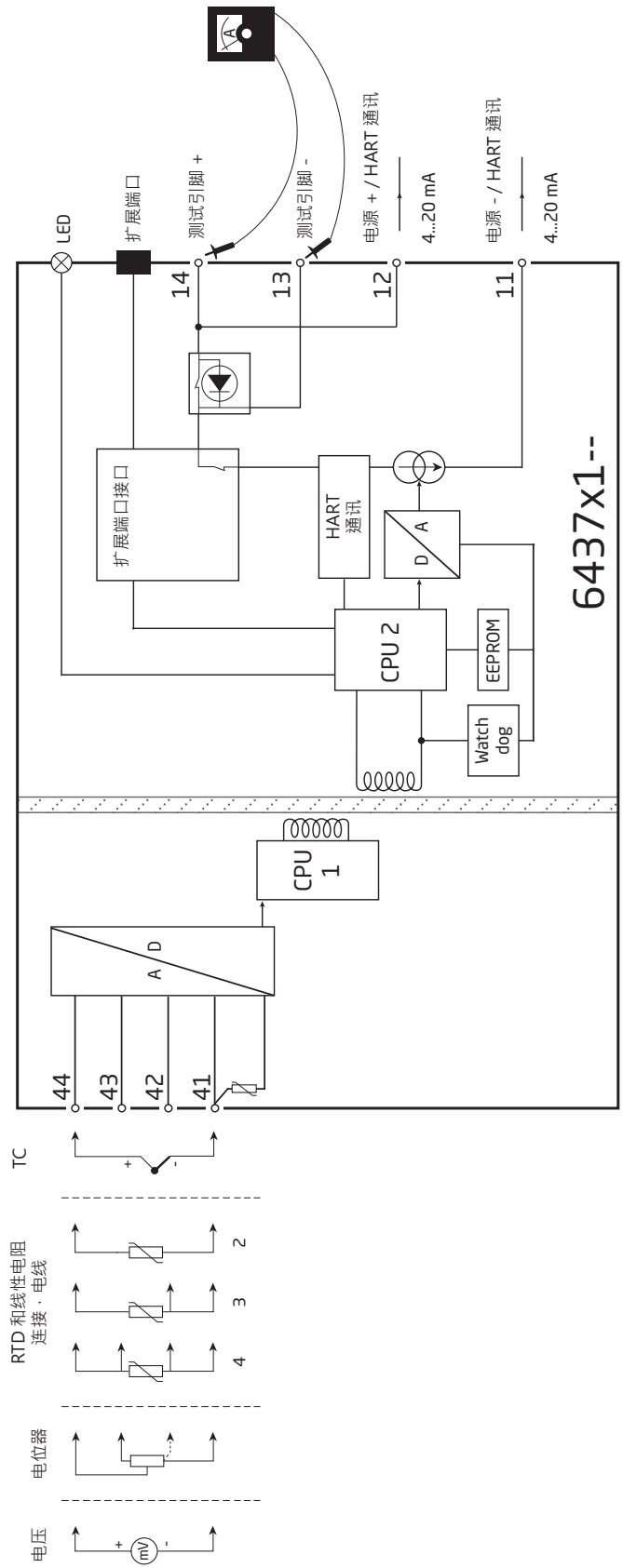

有关输入连接的完整概述，请参阅第 22 页。

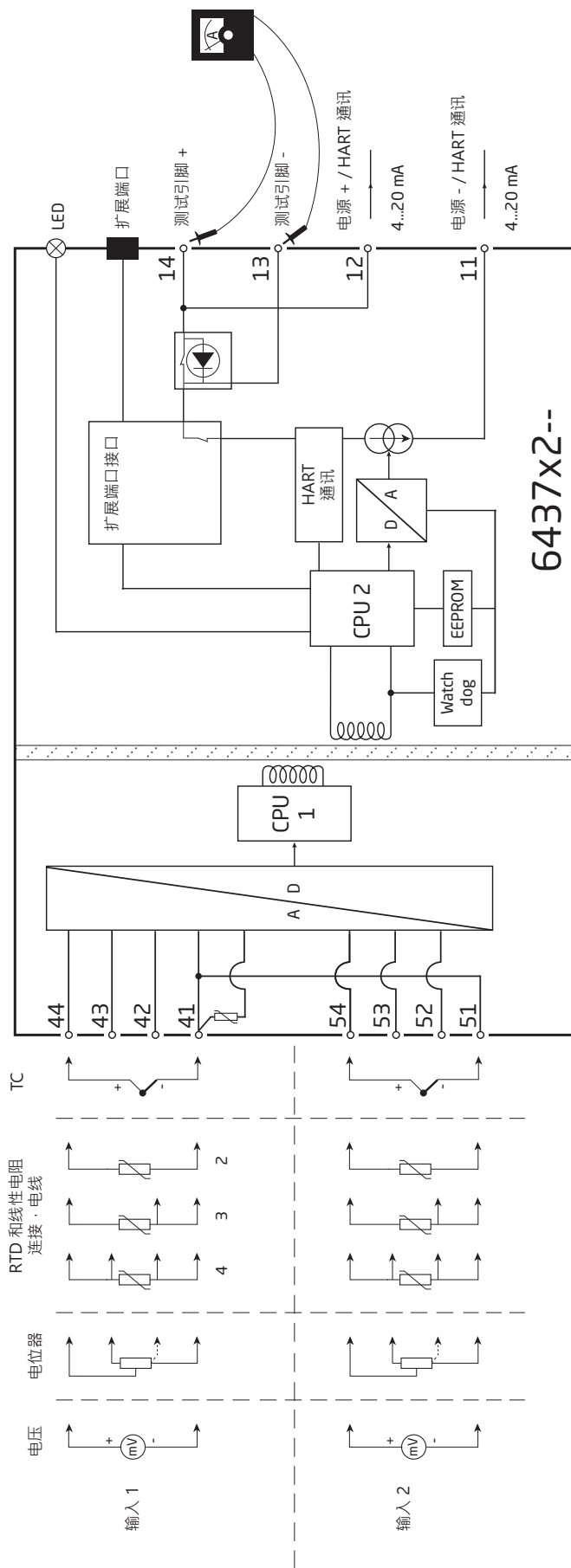

有关输入连接的完整概述·
请参阅第 22 页。

设置参数

6437 可以通过以下 4 种方式进行配置：

1. 通过 PR electronics A/S' 的回路通讯器和电脑 PReset 配置软件。
2. 通过 HART 调制解调器和电脑 PReset 配置软件。
3. 通过具备 PR electronics A/S' DDL 驱动的 HART 通讯器。
4. 通过通用软件，例如 DCS·PACTWare 等。

1: 回路通讯器

有关参数设置，请参阅下图和 PReset 软件中的帮助功能。

与未安装的设备进行通信时，可在安全区域拆卸连接器 11、12、13、14 (通道 1) 和 21、22、23、24 (通道 2)，以便将通信接口端子连接至引脚。

回路通讯器不允许与危险 (Ex) 区域中安装的设备进行通信。

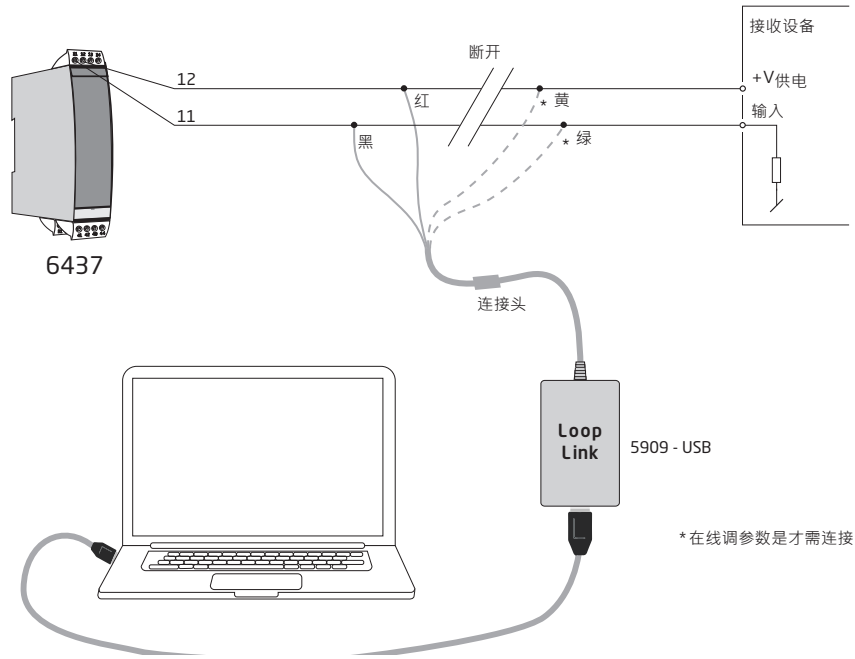

2: HART 调制解调器

有关参数设置，请参阅下图和 PReset 软件中的帮助功能。

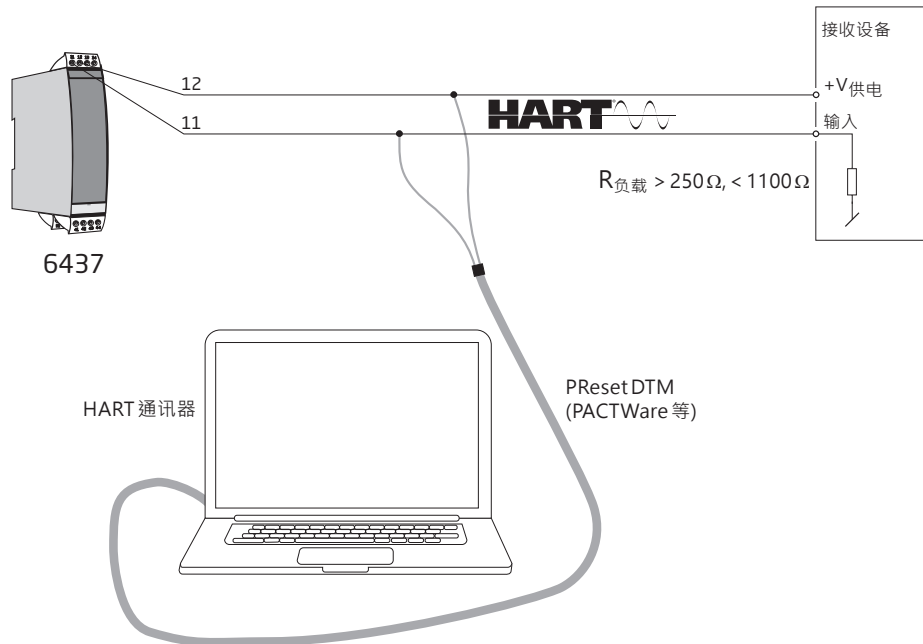

3: HART 通讯器

请参考下图。要访问特定产品菜单，HART 通信器必须装有 PR electronics A/S DD 驱动文件。可以从 HART Communication Foundation 或 PR electronics A/S 下载它们。

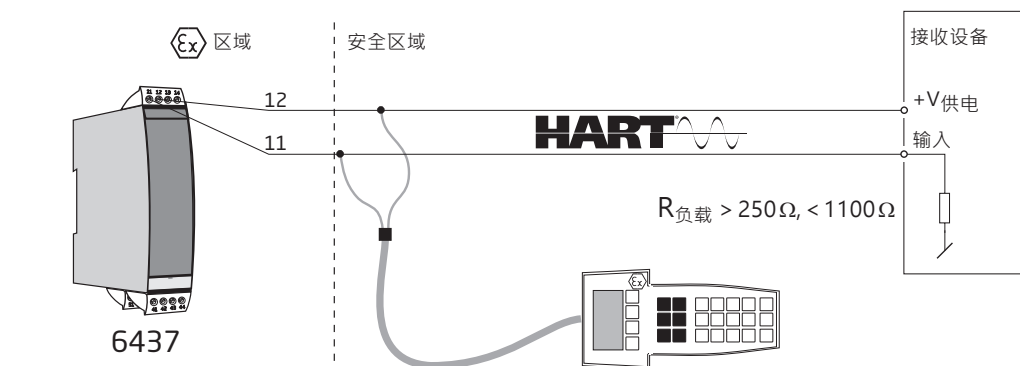

4: 通用配置软件

支持 EDD 和 FDT / DTM 技术。通过相关 DCS / 资产管理系统提供配置和监控，并支持管理软件包，例如 PACTware。

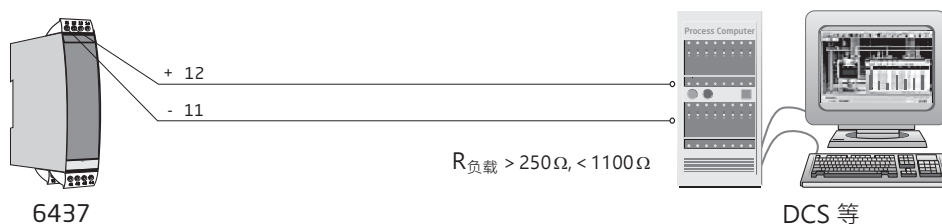

变送器多点模式连接

- 通过 HART 通信器或 HART 调制解调器进行通信。
- HART 通信器或 HART 调制解调器可以连接 AB 或 BC。
- 二线 HART 数字通讯，可以并联连接最多 63 个变送器。
- 在连接之前，每个变送器必须配置一个唯一的轮询地址，范围从 1 到 63。如果两个变送器配置了相同的地址，则两者都将被排除。变送器必须配置为多点模式（固定输出 4 mA 不变）。因此，回路中的最大电流为 252 mA。
- PReset 配置软件可以将单个变送器配置为多点模式，并为其提供唯一的轮询地址。

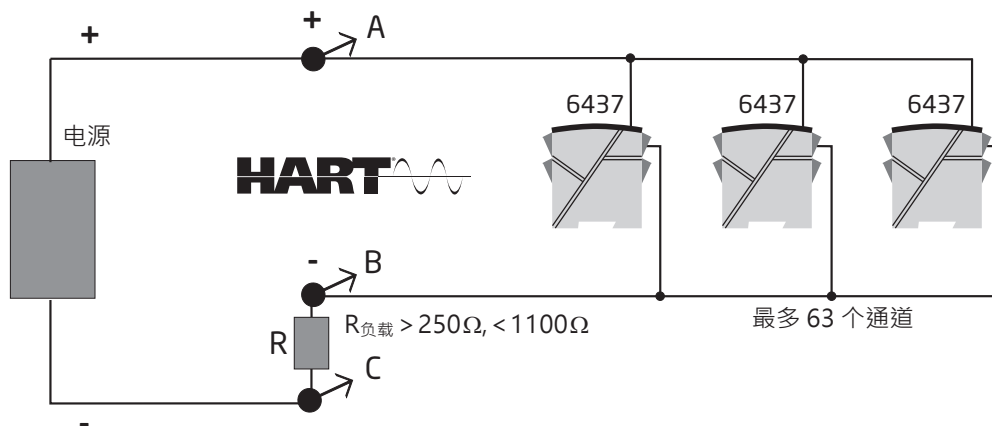

ATEX 安装图 - 6437QA01-V4R0

ATEX 认证
标准:

DEKRA 16ATEX 0047X
EN 60079-0:2018, EN60079-11:2012

Ex ia 安装

为安全安装 6431Dxxx 和 6437Dxxx，必须遵守以下规定。

标记牌



II 1 G Ex ia IIC T6...T4 Ga or
II 2(1) G Ex ib [ia Ga] IIC T6...T4 Gb
II 2 D Ex ia IIIC Db
I M1 Ex ia I Ma

危险区

Zone 0, 1, 2, 21, 22 和 M1

未分类区域

端子: :

54,53,52,51 和
44,43,42,41

Uo: 7.2 VDC
Io: 7.3 mA
Po: 13.2 mW
Lo: 667 mH
Co: 13.5µF

643xD

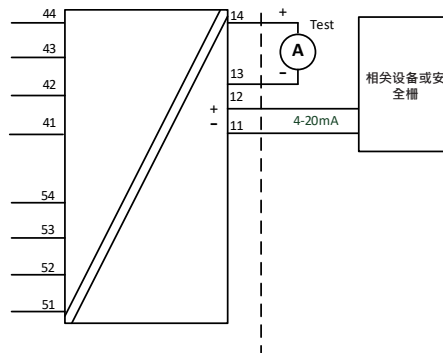

端子:

44,43,42,41

Uo: 7.2 VDC
Io: 7.3 mA
Po: 13.2 mW
Lo: 667 mH
Co: 13.5µF

643xD3

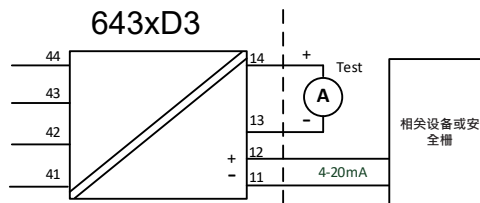

端子:

54,53,52,51

Uo: 7.2 VDC
Io: 7.3 mA
Po: 13.2 mW
Lo: 667 mH
Co: 13.5µF

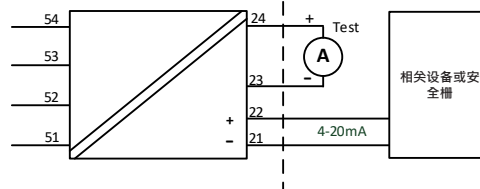

Ex ib 安装

危险区
Zone 0, 1, 2,
21, 22 和 M1

危险区
Zone 1

未分类区域

端子:

54,53,52,51 和
44,43,42,41

Uo: 7.2 VDC
Io: 7.3 mA
Po: 13.2 mW
Lo: 667 mH
Co: 13.5 μ F

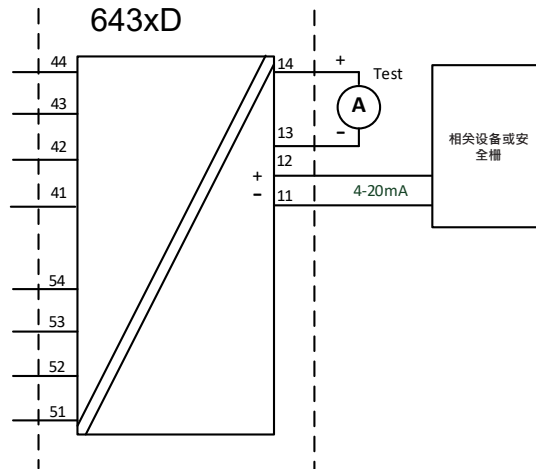

端子:

44,43,42,41

Uo: 7.2 VDC
Io: 7.3 mA
Po: 13.2 mW
Lo: 667 mH
Co: 13.5 μ F

端子:

54,53,52,51

Uo: 7.2 VDC
Io: 7.3 mA
Po: 13.2 mW
Lo: 667 mH
Co: 13.5 μ F

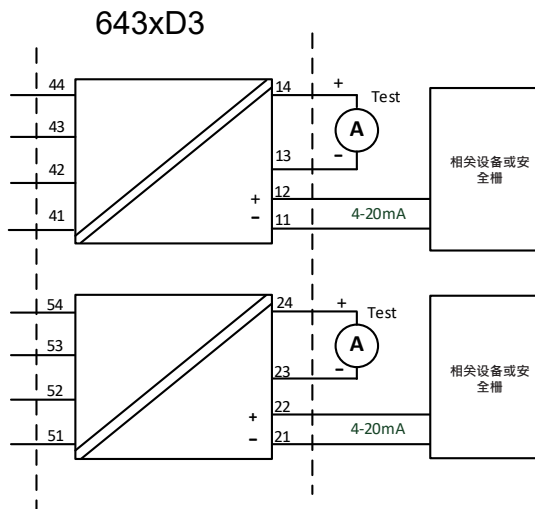

643xD1: 端子: 11,12			
643xD2: 端子: 11,12			
643xD3: 端子: 通道 1: 11,12 通道 2: 21,22			
Ex ia 和 ib 安装			
Ui: 30 VDC; li: 120 mA; Li: 0 μH; Ci: 1.0nF			
P _i 每个频道	温度等级	最高环境温度	
		单输入和双输入	双通道
900 mW	T6	+50 °C	+45 °C
	T5	+65 °C	+60 °C
	T4	+85 °C	+85 °C
750 mW	T6	+55 °C	+50 °C
	T5	+70 °C	+65 °C
	T4	+85 °C	+85 °C
610 mW	T6	+60 °C	+55 °C
	T5	+75 °C	+70 °C
	T4	+85 °C	+85 °C

一般安装说明

设备制造年份由序列号的前两位数字指示。

如果外壳由非金属塑料材料制成，应避免变送器外壳上的静电荷。

各端子（包括接线的裸露部分）应与任何接地金属保持至少 3 mm 的间距。

测试引脚可以直接测量回路电流，并同时保持工作回路不中断。使用测试引脚时，变送器必须连接电源。对于危险区域安装，只能使用经过认证的测试设备。

若变送器之前保护类型为 Ex nA 或 Ex ec，则之后可能不适用于本安型应用。

前置连接器和前置测试点提供本安型扩展端口信号，仅可连接至 PR electronics 的指定设备。

警告：不得在通电时操作插头和插座。

对于安装在潜在爆炸性粉尘环境中，必须遵循以下说明：

变送器应安装于符合 EN 60529 标准至少具备 IP5X 防护等级的外壳中。外壳应适合应用环境并正确安装。

电缆入口装置和堵封件应满足相同的要求。

对于 EPL Db，外壳的表面温度比环境温度高 +20 K，确定没有灰尘层。

对于矿井安装，必须遵循以下说明：

变送器应安装于符合 EN 60529 标准至少具备 IP54 防护等级的金属材质外壳中。

铝材质外壳不允许用于矿井。

外壳应适合应用环境并正确安装。

电缆入口装置和堵封件应满足相同的要求。

Ex nA / Ex ec / Ex ic 安装

为安全安装 6431Axxx 和 6437Axxx，必须遵守以下规定。

ATEX 认证
标准:

DEKRA 18ATEX0135X
EN 60079-0 : 2018, EN 60079-11 : 2012
EN 60079-7 : 2015+A1:2018, EN 60079-15 : 2010

标志

II 3 G Ex nA IIC T6...T4 Gc
II 3 G Ex ec IIC T6...T4 Gc
II 3 G Ex ic IIC T6...T4 Gc
II 3 D Ex ic IIIC Dc

危险区
Zone 2 和 22

未分类区域

端子:

54,53,52,51 和
44,43,42,41

Uo: 7.2 VDC
Io: 7.3 mA
Po: 13.2 mW
Lo: 667 mH
Co: 13.5 μ F

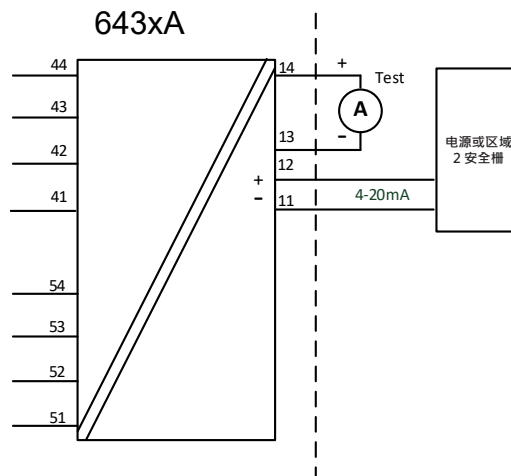

端子:

44,43,42,41

Uo: 7.2 VDC
Io: 7.3 mA
Po: 13.2 mW
Lo: 667 mH
Co: 13.5 μ F

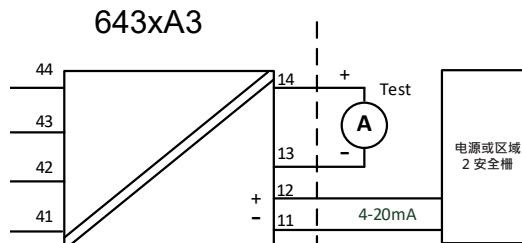

端子:

54,53,52,51

Uo: 7.2 VDC
Io: 7.3 mA
Po: 13.2 mW
Lo: 667 mH
Co: 13.5 μ F

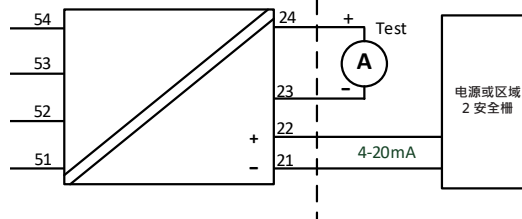

643xA1: 端子 44 43,42,41	
643xA2: 端子 输入 1: 44 43,42,41 输入 2: 54 53,52,51	
643xA3: 端子 通道 1: 44 43,42,41 通道 2: 54 53,52,51	
Ex nA & Ex ec	Ex ic
Vmax = 7.2VDC	Uo: 7.2 VDC; Io: 7.3 mA Po: 13.2 mW; Lo: 667 mH; Co: 13.5 μF

643xA1: 端子: 11,12					
643xA2: 端子: 11,12					
643xA3: 端子: 通道 1: 11,12 通道 2: 21,22					
供电/输出电路				最高环境温度	
Ex nA & Ex ec	Ex ic Li = 0 uH Ci = 1.0 nF	Ex ic Ui= 48 VDC, Li = 0 uH, Ci = 1.0 nF	温度等级	单输入和双输入	双通道
Vmax= 37 VDC	Ui= 37 VDC	Pi= 851 mW 每个频道	T4	+85 °C	+85 °C
			T5	+70 °C	+65 °C
			T6	+55 °C	+50 °C
Vmax= 30 VDC	Ui= 30 VDC	Pi= 700 mW 每个频道	T4	+85 °C	+85 °C
			T5	+75 °C	+70 °C
			T6	+60 °C	+55 °C

一般安装说明

如果外壳由非金属塑料材料制成，应避免变送器外壳上的静电荷。

若环境温度 $\geq 60^{\circ}\text{C}$ ，则应使用耐热电缆，其额定耐热温度至少应比环境温度高出 20 K。

外壳应适合应用环境并正确安装

各端子（包括接线的裸露部分）应与任何接地金属保持至少 3 mm 的间距

仅可在安全区域中，或者供电/输出电路和连接的电流表均为本安型时，方可使用 'TEST' 连接。

警告：不得在通电时连接或断开连接端子块。

对于安装在潜在爆炸性气体环境中，必须遵循以下说明：

变送器应安装于符合 EN 60079-0 标准至少具备 IP54 防护等级的外壳中。

此外，外壳应符合 EN 60664-1 标准规定的内部污染等级 2 或更高。

电缆入口装置和堵封件应满足相同的要求。

对于安装在潜在爆炸性粉尘环境中，必须遵循以下说明：

对于 EPL Dc，外壳的表面温度比环境温度高 +20 K，确定没有灰尘层。

若变送器连接本质安全信号“ic”，并且作为本质安全信号“ic”的接口界面（例如无源设备），则变送器应安装于符合 EN 60079-0 标准至少具备 IP54 防护等级的外壳。电缆入口装置和堵封件应满足相同的要求。

如果变送器安装在需要使用设备保护级别 Gc 的爆炸性环境中并应用 Ex nA 或 Ex ec 保护类型，则变送器应安装在外壳中，该外壳可根据 EN 60079-0 提供至少 IP54 的防护等级。

电缆入口设备和盲塞元件应符合相同的要求。

IECEX Installation drawing 6437QI01-V4R0

IECEX Certificate IECEX DEK 16.0029X
 Standards: IEC 60079-0:2017, IEC60079-11:2011,
 IEC 60079-15:2010, IEC60079-7: 2017

Ex ia Installation

For safe installation of the 6431Dxxx and 6437Dxxx the following must be observed.

Marking Ex ia IIC T6...T4 Ga or
 Ex ib [ia Ga] IIC T6...T4 Gb
 Ex ia IIIC Db
 Ex ia I Ma

Hazardous Area
 Zone 0, 1, 2, 21, 22 and M1

Unclassified Area

Terminal:
 54,53,52,51 and
 44,43,42,41

Uo: 7.2 VDC
 Io: 7.3 mA
 Po: 13.2 mW
 Lo: 667 mH
 Co: 13.5µF

643xD

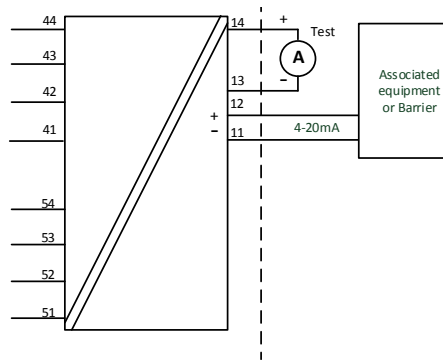

Terminal:
 44,43,42,41

Uo: 7.2 VDC
 Io: 7.3 mA
 Po: 13.2 mW
 Lo: 667 mH
 Co: 13.5µF

643xD3

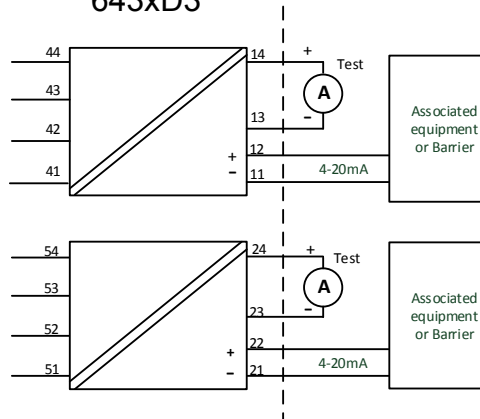

Terminal:
 54,53,52,51

Uo: 7.2 VDC
 Io: 7.3 mA
 Po: 13.2 mW
 Lo: 667 mH
 Co: 13.5µF

Ex ib Installation

Hazardous Area
Zone 0, 1, 2,
21, 22 and M1

Hazardous Area
Zone 1

Unclassified Area

Terminal:

54,53,52,51 and
44,43,42,41

Uo: 7.2 VDC
Io: 7.3 mA
Po: 13.2 mW
Lo: 667 mH
Co: 13.5µF

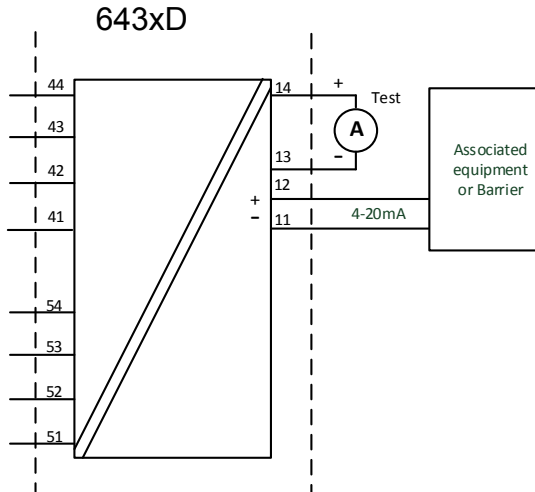

Terminal:

44,43,42,41

Uo: 7.2 VDC
Io: 7.3 mA
Po: 13.2 mW
Lo: 667 mH
Co: 13.5µF

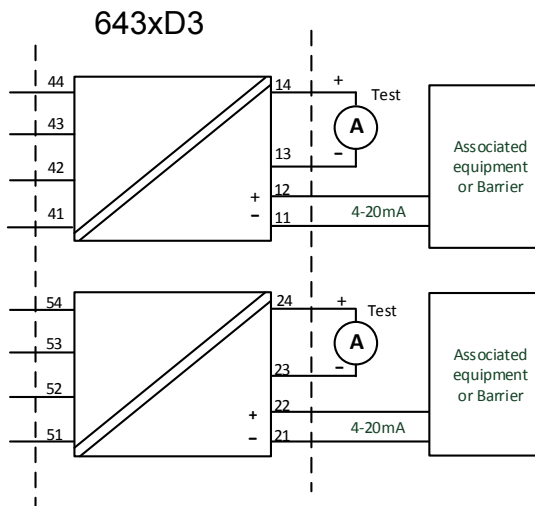

Terminal:

54,53,52,51

Uo: 7.2 VDC
Io: 7.3 mA
Po: 13.2 mW
Lo: 667 mH
Co: 13.5µF

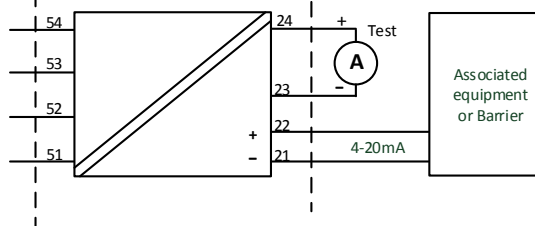

643xD1: Terminal: 11,12			
643xD2: Terminal: 11,12			
643xD3: Terminal: Ch1: 11,12 Ch2: 21,22			
Ex ia and ib installation			
Ui: 30 VDC; li: 120 mA; Li: 0 µH; Ci: 1 nF			
P _i per channel	Temperature class	Maximum ambient temperature	
		Single and dual input	Two channel
900 mW	T6	+50 °C	+45 °C
	T5	+65 °C	+60 °C
	T4	+85 °C	+85 °C
750 mW	T6	+55 °C	+50 °C
	T5	+70 °C	+65 °C
	T4	+85 °C	+85 °C
610 mW	T6	+60 °C	+55 °C
	T5	+75 °C	+70 °C
	T4	+85 °C	+85 °C

General installation instructions

If the enclosure is made of non-metallic plastic materials, electrostatic charges on the transmitter enclosure shall be avoided.

For EPL Ga, if the enclosure is made of aluminum, it must be installed such, that ignition sources due to impact and friction sparks are excluded.

The distance between terminals, inclusive the wire's bare part, shall be at least 3 mm separated from any earthed metal.

The test pins allow measurement of loop current directly while maintaining loop integrity. Power must be connected to the transmitter when using the test pins. For hazardous area installation, only certified test equipment may be used.

If the transmitter was applied in type of protection Ex nA or Ex ec, it may afterwards not be applied for intrinsic safety.

The front connector and front test pads provides an intrinsically safe extension-port signal and may only be connected to dedicated equipment of PR electronics.

Warning: Do not connect or disconnect plugs and sockets when energized.

For installation in a potentially explosive dust atmosphere, the following instructions apply:

If the transmitter is installed in an explosive atmosphere requiring the use of equipment protection level Db or Dc and applied in type of protection Ex ia or Ex ic, the transmitter shall be mounted in enclosure that provides a degree of protection of at least IP5X according to IEC 60079-0, and that is suitable for the application and correctly installed.

Cable entry devices and blanking elements shall fulfill the same requirements.

The surface temperature of the outer enclosure is +20 K above the ambient temperature, determined without a dust layer.

For installation in mines the following instructions apply:

The transmitter shall be mounted in a metal enclosure that is providing a degree of protection of at least IP54 according to IEC60529.

Aluminum enclosures are not allowed for mines.
 The enclosure shall be suitable for the application and correctly installed.
 Cable entry devices and blanking elements shall fulfill the same requirements.

Ex nA / Ex ec / Ex ic Installation

For safe installation of the 6431Axxx and 6437Axxx the following must be observed.

Marking
 Ex nA IIC T6...T4 Gc
 Ex ec IIC T6...T4 Gc
 Ex ic IIC T6...T4 Gc
 Ex ic IIIC Dc

Hazardous Area
 Zone 2 and 22

Unclassified Area

Terminal:
 54,53,52,51 and
 44,43,42,41

Uo: 7.2 VDC
 Io: 7.3 mA
 Po: 13.2 mW
 Lo: 667 mH
 Co: 13.5µF

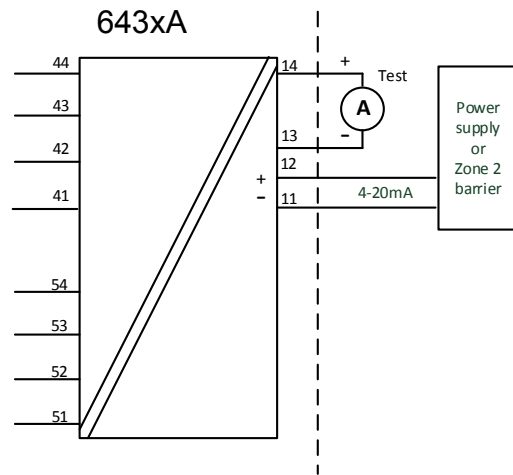

Terminal:
 44,43,42,41

Uo: 7.2 VDC
 Io: 7.3 mA
 Po: 13.2 mW
 Lo: 667 mH
 Co: 13.5µF

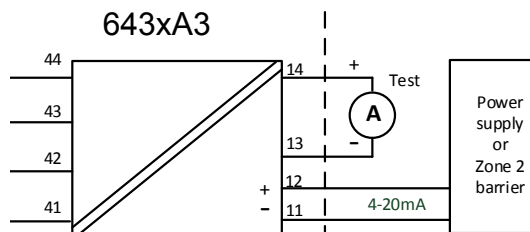

Terminal:
 54,53,52,51

Uo: 7.2 VDC
 Io: 7.3 mA
 Po: 13.2 mW
 Lo: 667 mH
 Co: 13.5µF

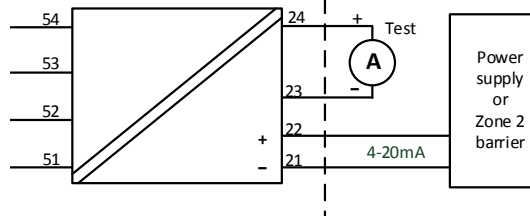

643xA1: Terminal 44 43,42,41	
643xA2: Terminal In1: 44 43,42,41 In2: 54 53,52,51	
643xA3 : Terminal Ch1: 44 43,42,41 Ch2: 54 53,52,51	
Ex nA & Ex ec	Ex ic
Vmax = 7.2VDC	Uo: 7.2 VDC; Io: 7.3 mA Po: 13.2 mW; Lo: 667 mH; Co: 13.5µF

643xA1: Terminal: 11,12					
643xA2: Terminal: 11,12					
643xA3: Terminal: Ch1: 11,12 Ch2: 21,22					
Supply / output circuit				Maximum ambient temperature	
Ex nA & Ex ec	Ex ic Li = 0 uH Ci = 1 nF	Ex ic Ui= 48 VDC, Li = 0 uH, Ci = 1 nF	Temperature class	Single and dual input	Two channel
Vmax= 37 VDC	Ui= 37 VDC	Pi= 851 mW per channel	T4	+85 °C	+85 °C
			T5	+70 °C	+65 °C
			T6	+55 °C	+50 °C
Vmax= 30 VDC	Ui= 30 VDC	Pi= 700 mW per channel	T4	+85 °C	+85 °C
			T5	+75 °C	+70 °C
			T6	+60 °C	+55 °C

General installation instructions

If the enclosure is made of non-metallic plastic materials, electrostatic charges on the transmitter enclosure shall be avoided.

For an ambient temperature $\geq 60^{\circ}\text{C}$, heat resistant cables shall be used with a rating of at least 20 K above the ambient temperature.

The enclosure shall be suitable for the application and correctly installed

The distance between terminals, inclusive the wires bare part, shall be at least 3 mm separated from any earthed metal

'TEST' connection, may only be applied when the area is safe, or if supply / output circuit and the applied current meter are intrinsically safe.

Warning: Do not connect or disconnect Terminal Blocks when energized.

For installation in a potentially explosive gas atmosphere, the following instructions apply:

The transmitter shall be installed in an enclosure providing a degree of protection of not less than IP54 in accordance with IEC 60079-0, which is suitable for the application and correctly installed e.g. in an enclosure that is in type of protection Ex n or Ex e. Additionally, the area inside the enclosure shall be pollution degree 2 or better as defined in IEC 60664-1.

Cable entry devices and blanking elements shall fulfill the same requirements.

For installation in a potentially explosive dust atmosphere, the following instructions apply:

For EPL Dc, the surface temperature of the outer enclosure is +20 K above the ambient temperature, determined without a dust layer.

If the transmitter is supplied with an intrinsically safe signal "ic" and interfaces an intrinsically safe signal "ic" (e.g. a passive device), the transmitter shall be mounted in an enclosure that provides a degree of protection of at least IP54 according to IEC 60079-0. Cable entry devices and blanking elements shall fulfill the same requirements.

If the transmitter is installed in an explosive atmosphere requiring the use of equipment protection level Gc and applied in type of protection Ex nA or Ex ec, the transmitter shall be mounted in enclosure that provides a degree of protection of at least IP54 according to IEC 60079-0, and that is suitable for the application and correctly installed. Cable entry devices and blanking elements shall fulfill the same requirements.

CSA Installation drawing 6437QC01-V3R0

CSA Certificate 16.70066266

Division1 / Ex ia, Intrinsic Safe Installation

For safe installation of the 6431Dxxx and 6437Dxxx the following must be Observed.

Marking: Class I Division 1, Groups A,B,C,D
 Ex ia IIC T6...T4
 Class I, Zone 0: AEx ia IIC, T6...T4
 Ex ib [ia] IIC T6...T4
 Class I, Zone 1: AEx ib [ia] IIC T6...T4

IS Installation instructions

- Install in accordance with the US the National Electrical Code (NEC) or for Canada the Canadian Electrical Code (CEC).
- The transmitter must be installed in a suitable enclosure to meet installation codes stipulated in the Canadian Electrical Code (CEC) or for US the National Electrical Code (NEC).
- To establish Class II and Class III, Division 1 or IIIC ratings, the equipment shall be installed in an enclosure that is approved for use in Class II and Class III hazardous (classified) locations.
- If the enclosure is made of non-metallic materials or of painted metal, electrostatic charging shall be avoided.
- Use supply wires with a rating of at least 5 K above the ambient temperature.

WARNING: Substitution of components may impair intrinsic safety

AVERTISSEMENT: la substitution de composants peut nuire à la sécurité intrinsèque

Hazardous Area
 CL I, DIV 1 or
 CL I, Zone 0

Non Classified Area

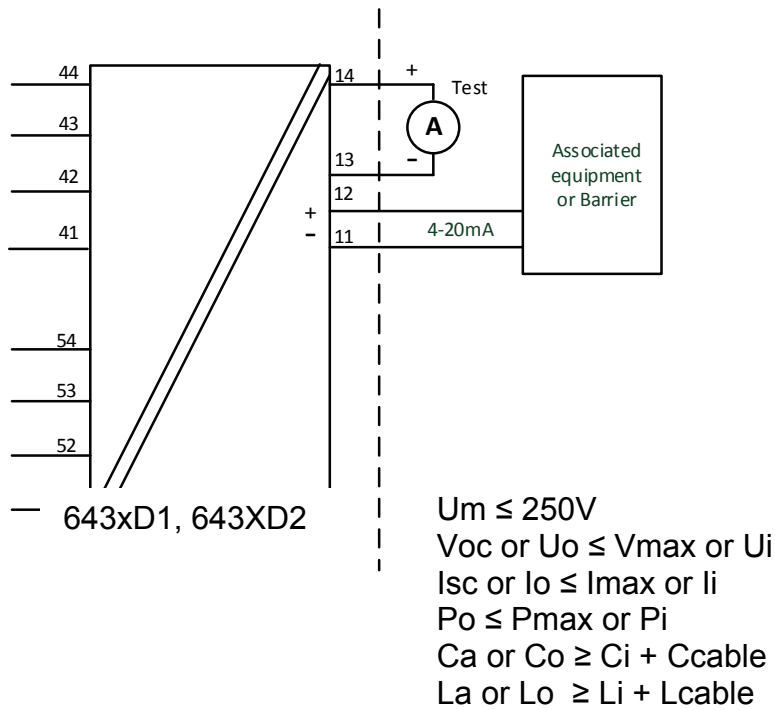

	Terminal 44,43,42,41 and 54,53,52,51	Terminal 44,43,42,41,54,53,52,51
Uo	7.2 VDC	7.2 VDC
Io:	7.3 mA	12.9 mA
Po	13.2 mW	23.3 mW
Lo:	667 mH	200 mH
Co	13.5 μF	13.5 μF

Terminal 11,12 Ex ia / Div 1;	Temperature Range
Ui: 30 VDC; Ii: 120 mA ; Pi:900 mW; Li:0 μH; Ci:1.0nF	T4: -50 ≤ Ta ≤ 85°C T5: -50 ≤ Ta ≤ 70°C T6: -50 ≤ Ta ≤ 55°C
Ui: 30 VDC; Ii: 100 mA ; Pi:750 mW; Li:0 μH; Ci:1.0nF	T4: -50 ≤ Ta ≤ 85°C T5: -50 ≤ Ta ≤ 75°C T6: -50 ≤ Ta ≤ 60°C

Hazardous Area
CL I, DIV 1 or
CL I, Zone 0

Non Classified Area

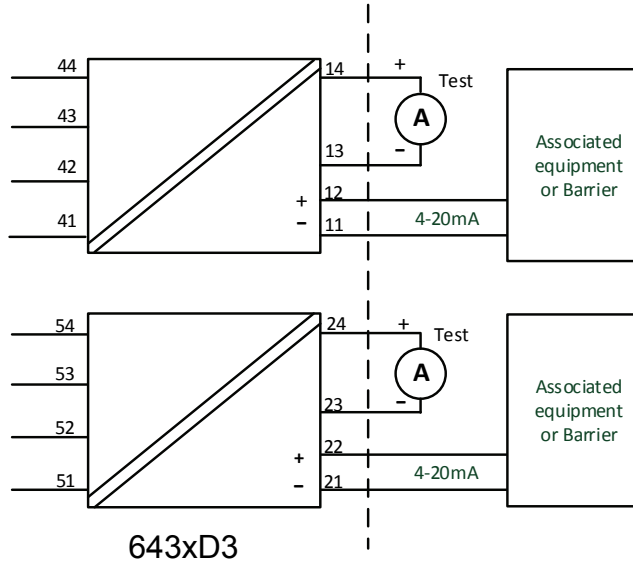

$U_m \leq 250V$
 $V_{oc} \text{ or } U_o \leq V_{max} \text{ or } U_i$
 $I_{sc} \text{ or } I_o \leq I_{max} \text{ or } I_i$
 $P_o \leq P_{max} \text{ or } P_i$
 $C_a \text{ or } C_o \geq C_i + C_{cable}$
 $L_a \text{ or } L_o \geq L_i + L_{cable}$

	Terminal 44,43,42,41 and 54,53,52,51
U _o	7.2 VDC
I _o	7.3 mA
P _o	13.2 mW
L _o	667 mH
C _o	13.5 μF

Terminal 11,12 and 21 22 Ex ia / Div 1	Temperature Range
P _i : 900 mW U _i : 30 VDC; I _i : 120 mA L _i : 0 μH; C _i : 1.0nF	T4: -50 ≤ T _a ≤ 85°C T5: -50 ≤ T _a ≤ 70°C T6: -50 ≤ T _a ≤ 55°C
P _i : 750 mW U _i : 30 VDC; I _i : 100 mA L _i : 0 μH; C _i : 1.0nF	T4: -50 ≤ T _a ≤ 85°C T5: -50 ≤ T _a ≤ 75°C T6: -50 ≤ T _a ≤ 60°C

Zone 0 / Zone 1, Intrinsic Safe Installation

Hazardous Area
CL I, Zone 0 IIC

Hazardous Area
CL I, Zone 1 IIC

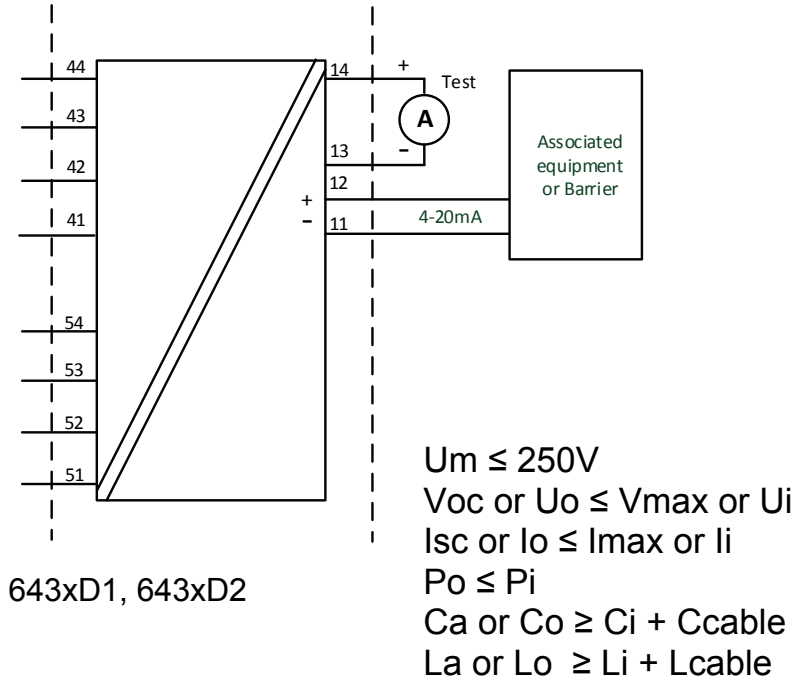

	Terminal 44,43,42,41 and 54,53,52,51	Terminal 44,43,42,41,54,53,52,51
Uo	7.2 VDC	7.2 VDC
Io:	7.3 mA	12.9 mA
Po	13.2 mW	23.3 mW
Lo:	667 mH	200 mH
Co	13.5 μ F	13.5 μ F

Terminal 11,12 Ex ib [ia Ga] IIC T6...T4 Gb;	Temperature Range
Pi:900 mW; Ui: 30 VDC; Ii: 120 mA ; Li:0 μ H; Ci:1.0nF	T4: $-50 \leq T_a \leq 85^\circ C$ T5: $-50 \leq T_a \leq 70^\circ C$ T6: $-50 \leq T_a \leq 55^\circ C$
Pi:750 mW; Ui: 30 VDC; Ii: 100 mA ; Li:0 μ H; Ci:1.0nF	T4: $-50 \leq T_a \leq 85^\circ C$ T5: $-50 \leq T_a \leq 75^\circ C$ T6: $-50 \leq T_a \leq 60^\circ C$

Hazardous Area
CL I, Zone 0 IIC

Hazardous Area
CL I, Zone 1 IIC

Non Classified Area

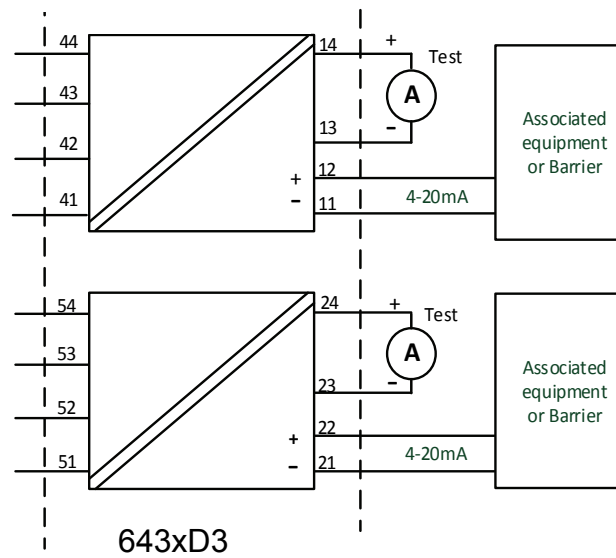

$U_m \leq 250V$
 $V_{oc} \text{ or } U_o \leq V_{max} \text{ or } U_i$
 $I_{sc} \text{ or } I_o \leq I_{max} \text{ or } I_i$
 $P_o \leq P_i$
 $C_a \text{ or } C_o \geq C_i + C_{cable}$
 $L_a \text{ or } L_o \geq L_i + L_{cable}$

	Terminal 44,43,42,41 and 54,53,52,51
U _o	7.2 VDC
I _o	7.3 mA
P _o	13.2 mW
L _o	667 mH
C _o	13.5 μF

Terminal 11,12 and 21 22 Ex ib [ia Ga] IIC T6...T4 Gb	Temperature Range
P _i : 900 mW U _i : 30 VDC; I _i : 120 mA L _i : 0 μH; C _i : 1.0nF	T4: -50 ≤ T _a ≤ 85°C T5: -50 ≤ T _a ≤ 70°C T6: -50 ≤ T _a ≤ 55°C
P _i : 750 mW U _i : 30 VDC; I _i : 100 mA L _i : 0 μH; C _i : 1.0nF	T4: -50 ≤ T _a ≤ 85°C T5: -50 ≤ T _a ≤ 75°C T6: -50 ≤ T _a ≤ 60°C

Division 2 / Ex nA, Non Incendive Installation

For safe installation of the 6431Axxx and 6437Axxx the following must be observed.

Marking Class I, Division 2, Groups A, B, C, D
 Ex nA IIC T6...T4
 Class I, Zone 2: AEx nA IIC T6...T4
 Ex nA [ic] IIC T6...T4
 Class I, Zone 2: AEx nA [ic] IIC T6...T4

Hazardous Area

CL I, Div 2, GP ABCD 643xA
 CL I, Zone 2, IIC

Unclassified Area

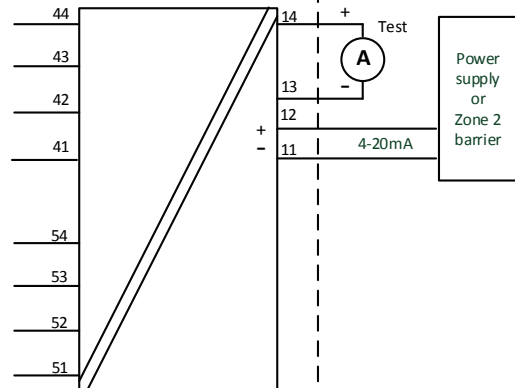

643xA3

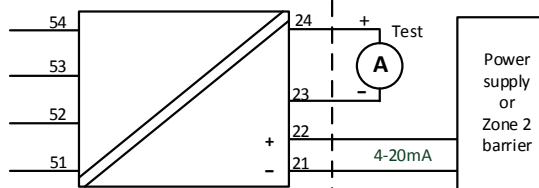
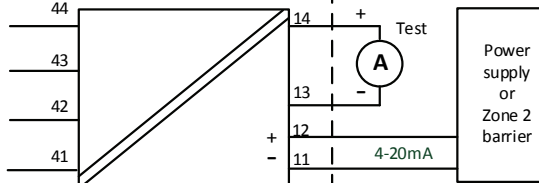

Terminal:

54,53,52,51
 44,43,42,41

Vmax: 7.2 VDC

Terminal 11, 12 and 21, 22 Ex nA	Temperature Range
Supply voltage: max 37 VDC	T4: $-50 \leq T_a \leq 85^{\circ}\text{C}$ T5: $-50 \leq T_a \leq 70^{\circ}\text{C}$ T6: $-50 \leq T_a \leq 55^{\circ}\text{C}$
Supply voltage: max 30 VDC	T4: $-50 \leq T_a \leq 85^{\circ}\text{C}$ T5: $-50 \leq T_a \leq 75^{\circ}\text{C}$ T6: $-50 \leq T_a \leq 60^{\circ}\text{C}$

NI Installation instructions

- The transmitter must be installed in an enclosure providing a degree of protection of at least IP54 according to IEC60529 that is suitable for the application and is correctly installed. Cable entry devices and blanking elements shall fulfill the same requirements.
- If the enclosure is made of non-metallic materials or of painted metal, electrostatic charging shall be avoided.
- Use supply wires with a rating of at least 5 K above the ambient temperature.

WARNING: Substitution of components may impair suitability for Class I, Division 2

AVERTISSEMENT: la substitution de composants peut nuire à l'aptitude à la Classe I, Division 2.

WARNING: Do not disconnect equipment unless power has been switched off or the area is known to be safe.

AVERTISSEMENT: Ne débranchez pas l'équipement sauf si l'alimentation a été coupée ou si la zone est connue pour être sûre.

Non Incendive field wiring installation

The non incendive field Wiring Circuit concept allows interconnection of Nonincendive Field wiring Apparatus with Associated Nonincendive Field Wiring Apparatus or Associated Intrinsically Safe Apparatus or Associated Apparatus not specially examined in combination as a system using any of the wiring methods permitted for unclassified locations, $V_{oc} < V_{max}$, $C_a \geq C_i + C_{cable}$, $L_a \geq L_i + L_{cable}$.

Terminal 11, 12 and 21, 22 Non Incendive Field wiring parameters	Temperature Range
$V_{max} = 30 \text{ VDC}$, $C_i = 1\text{nF}$, $L_i = 0$	T4: $-50 \leq T_a \leq 85^{\circ}\text{C}$ T5: $-50 \leq T_a \leq 75^{\circ}\text{C}$ T6: $-50 \leq T_a \leq 60^{\circ}\text{C}$

Functional Ratings:

$U_{nom} \leq 30 \text{ VDC}$; $I_{nom} \leq 3.5 - 23 \text{ mA}$

FM Installation drawing 6437QF01-V2R0

Division 1 / Zone 0, Intrinsic Safe Installation

For safe installation of the 6431Dxxx and 6437Dxxx the following must be observed.

Marking
 CL I, Div 1, Gp A,B,C,D
 CL I, Zone 0 AEx ia IIC, T6...T4
 CL I, Zone 1 [0] AEx ib [ja] IIC, T6...T4
 Ex ia IIC, T6...T4
 Ex ib [ja Ga] IIC, T6...T4 Gb

Hazardous Area

CL I, Div 1, GP ABCD
 CL I, Zone0 IIC

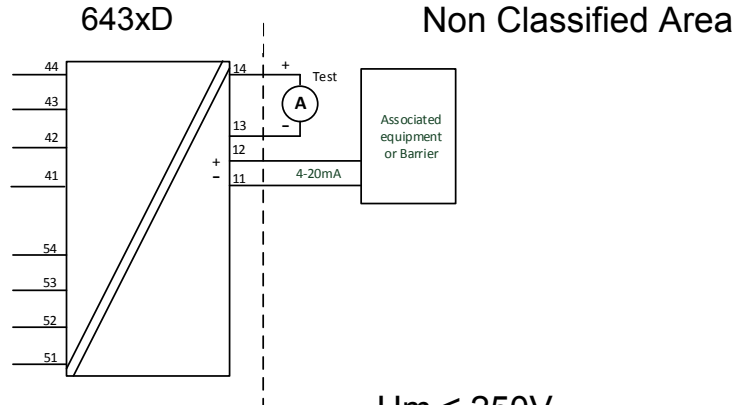

Terminals:

54,53,52,51
 44,43,42,41

U_o: 7.2 VDC
 I_o: 12.9 mA
 P_o: 23.3 mW
 L_o: 200 mH
 C_o: 13.5µF

U_m ≤ 250V
 V_{oc} or U_o ≤ V_{max} or U_i
 I_{sc} or I_o ≤ I_{max} or I_i
 P_o ≤ P_i
 C_a or C_o ≥ C_i + C_{cable}
 L_a or L_o ≥ L_i + L_{cable}

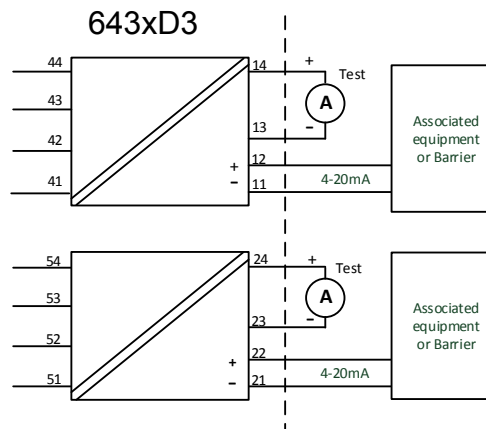

Terminal 11,12 and 21, 22 Ex ia / Div 1	Temperature Range
AEx/Ex ia IIC, T6...T4 Ga CL I, Div 1, Gp ABCD, T6...T4;	
Ui: 30 VDC; li: 120 mA ; Pi:900 mW; Li:0 μH; Ci:1.0nF	T4: $-50 \leq Ta \leq 85^{\circ}\text{C}$ T5: $-50 \leq Ta \leq 70^{\circ}\text{C}$ T6: $-50 \leq Ta \leq 55^{\circ}\text{C}$
Ui: 30 VDC; li: 100 mA ; Pi:750 mW; Li:0 μH; Ci:1.0nF	T4: $-50 \leq Ta \leq 85^{\circ}\text{C}$ T5: $-50 \leq Ta \leq 75^{\circ}\text{C}$ T6: $-50 \leq Ta \leq 60^{\circ}\text{C}$

Zone 0 / Zone 1, Intrinsic Safe Installation

Hazardous Area
CL I, Zone 0 IIC

Hazardous Area
CL I, Zone 1 IIC

Non Classified Area

Terminals:
54,53,52,51
44,43,42,41

Uo: 7.2 VDC
Io: 12.9 mA
Po: 23.3 mW
Lo: 200 mH
Co: 13.5μF

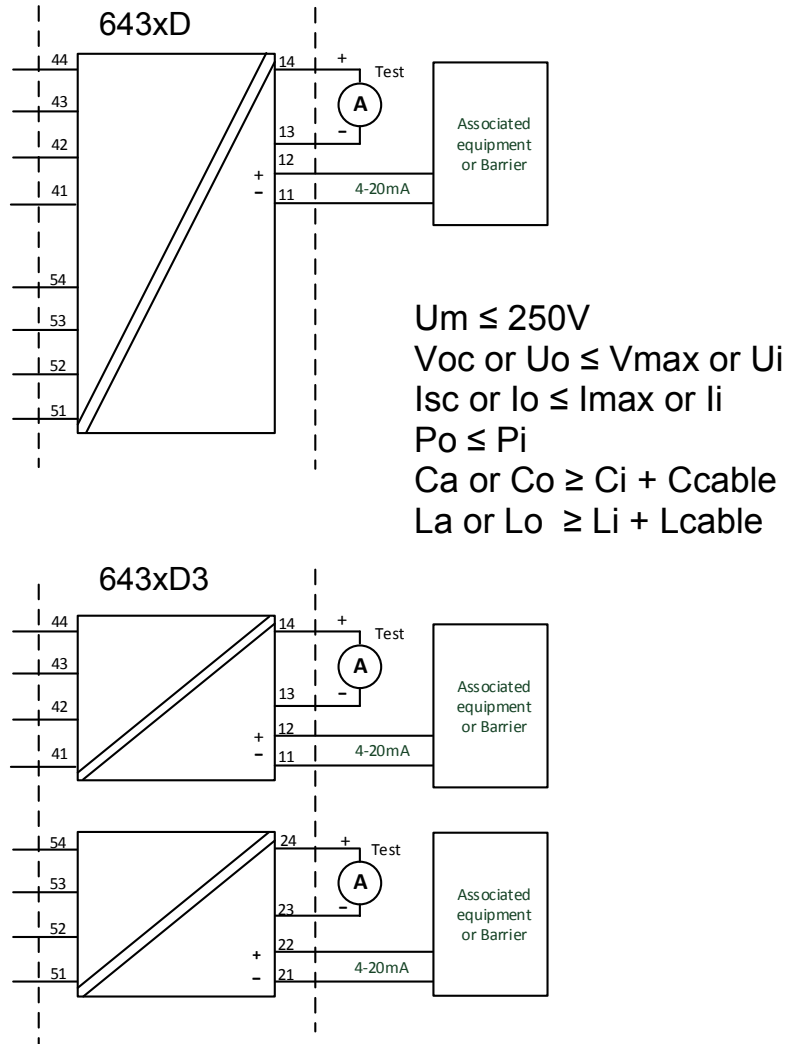

Terminal 11,12 and 21, 22 Ex ib [ia Ga] IIC T6...T4 Gb;	Temperature Range
Ui: 30 VDC; li: 120 mA ; Pi:900 mW; Li:0 µH; Ci:1.0nF	T4: $-50 \leq Ta \leq 85^{\circ}\text{C}$ T5: $-50 \leq Ta \leq 70^{\circ}\text{C}$ T6: $-50 \leq Ta \leq 55^{\circ}\text{C}$
Ui: 30 VDC; li: 100 mA ; Pi:750 mW; Li:0 µH; Ci:1.0nF	T4: $-50 \leq Ta \leq 85^{\circ}\text{C}$ T5: $-50 \leq Ta \leq 75^{\circ}\text{C}$ T6: $-50 \leq Ta \leq 60^{\circ}\text{C}$

IS installation instructions

- Install in accordance with the US the National Electrical Code (NEC) or for Canada the Canadian Electrical Code (CEC).
- Equipment that is FM-approved for intrinsic safety may be connected to barriers based on the ENTITY CONCEPT. This concept permits interconnection of approved transmitters, meters and other devices in combinations which have not been specifically examined by FM, provided that the agency's criteria are met. The combination is then intrinsically safe, if the entity concept is acceptable to the authority having jurisdiction over the installation.
- The entity concept criteria are as follows:
The intrinsically safe devices, other than barriers, must not be a source of power. The maximum voltage U_i (V_{max}) and current i_i (I_{max}), and maximum power P_i (P_{max}), which the device can receive and remain intrinsically safe, must be equal to or greater than the voltage (U_o or V_{oc} or V_t) and current (I_o or I_{sc} or I_t) and the power P_o which can be delivered by the barrier.
- The sum of the maximum unprotected capacitance (C_i) for each intrinsically device and the interconnecting wiring must be less than the capacitance (C_a) which can be safely connected to the barrier.
- The sum of the maximum unprotected inductance (L_i) for each intrinsically device and the interconnecting wiring must be less than the inductance (L_a) which can be safely connected to the barrier.
- The entity parameters U_o, V_{oc} or V_t and I_o, I_{sc} or I_t , and C_a and L_a for barriers are provided by the barrier manufacturer.
- The transmitter must be installed in a suitable enclosure to meet installation codes stipulated in the Canadian Electrical Code (CEC) or for US the National Electrical Code (NEC).
- If the enclosure is made of non-metallic materials or of painted metal, electrostatic charging shall be avoided.
- Use supply wires with a rating of at least 5 K above the ambient temperature.

WARNING: Substitution of components may impair intrinsic safety

AVERTISSEMENT: la substitution de composants peut nuire à la sécurité intrinsèque

Division 2 / Zone 2, Non Sparking Installation

For safe installation of the 6431Axxx and 6437Axxx the following must be observed.

Marking Class I, Division 2, GP A,B,C,D; T6...T4
 Class I, Zone 2 AEx nA IIC, T6...T4 Gc
 Class I, Zone 2 Ex nA IIC, T6...T4 Gc
 NIFW, CL I, Div 2, GP A,B,C,D

Hazardous Area
 CL I, Div 2, GP ABCD
 CL I, Zone 2 IIC

Unclassified Area

643xA

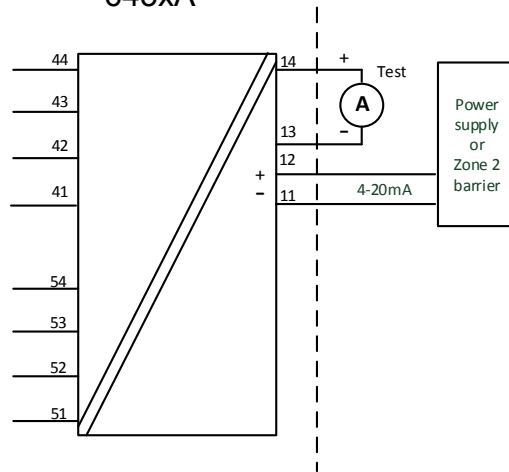

Terminal:
 54,53,52,51
 44,43,42,41

Vmax: 7.2 VDC

643xA3

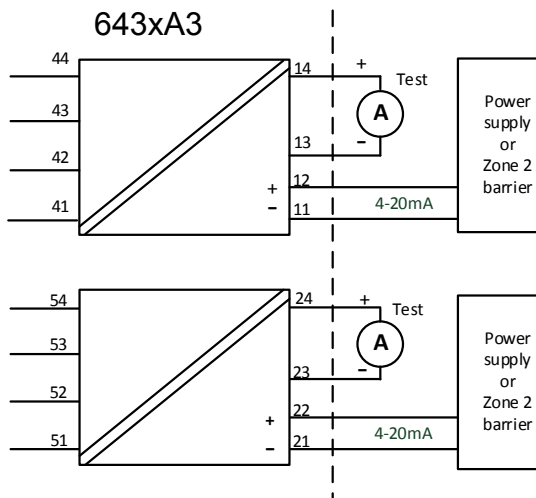

Terminal 11, 12 and 21, 22 Ex nA	Temperature Range
Supply voltage: max 37 VDC	T4: $-50 \leq T_a \leq 85^{\circ}\text{C}$ T5: $-50 \leq T_a \leq 70^{\circ}\text{C}$ T6: $-50 \leq T_a \leq 55^{\circ}\text{C}$
Supply voltage: max 30 VDC	T4: $-50 \leq T_a \leq 85^{\circ}\text{C}$ T5: $-50 \leq T_a \leq 75^{\circ}\text{C}$ T6: $-50 \leq T_a \leq 60^{\circ}\text{C}$

NI Installation instructions

- The transmitter must be installed in an enclosure providing a degree of protection of at least IP54 according to IEC60529 that is suitable for the application and is correctly installed. Cable entry devices and blanking elements shall fulfill the same requirements.
- If the enclosure is made of non-metallic materials or of painted metal, electrostatic charging shall be avoided.
- Use supply wires with a rating of at least 5 K above the ambient temperature.

WARNING: Substitution of components may impair suitability for Class I, Division 2
 AVERTISSEMENT: la substitution de composants peut nuire à l'aptitude à la Classe I, Division 2.

WARNING: Do not disconnect equipment unless power has been switched off or the area is known to be safe.

AVERTISSEMENT: Ne débranchez pas l'équipement sauf si l'alimentation a été coupée ou si la zone est connue pour être sûre.

Non Incendive field wiring installation

The non incendive field Wiring Circuit concept allows interconnection of Nonincendive Field wiring Apparatus with Associated Nonincendive Field Wiring Apparatus or Assosicated Intrinsically Safe Apparatus or Associated Apparatus not specially examined in combination as a syatem using any of the wiring methods permitted for unclassified locations, $V_{oc} < V_{max}$, $C_a \geq C_i + C_{cable}$, $L_a \geq L_i + L_{cable}$.

Terminal 11,12 and 21, 22 Non Incendive Field Wiring parameters	Temperature Range
$V_{max} = 30 \text{ VDC}$, $C_i = 1\text{nF}$, $L_i = 0$	T4: $-50 \leq T_a \leq 85^{\circ}\text{C}$ T5: $-50 \leq T_a \leq 75^{\circ}\text{C}$ T6: $-50 \leq T_a \leq 60^{\circ}\text{C}$

Functional Ratings:

$U_{nom} \leq 30 \text{ VDC}$; $I_{nom} \leq 3.5 - 23 \text{ mA}$

Instalação INMETRO 6437QB01-V4R1

INMETRO Certificado DEKRA 23.0002X

Normas: **ABNT NBR IEC 60079-0:2020 Versão Corrigida:2023**
ABNT NBR IEC 60079-7:2018 Versão Corrigida:2022
ABNT NBR IEC 60079-11:2013 Versão Corrigida:2017

Para a instalação segura do 6431Dxxx e 6437Dxxx os seguintes pontos devem ser observados

NOTAS Ex ia IIC T6...T4 Ga or
Ex ib [ia Ga] IIC T6...T4 Gb
Ex ia IIIC Db
Ex ia I Ma

Instalação Ex ia

Área Classificada
Zone 0, 1, 2, 21, 22 and M1

Área Não classificada

Terminais:

54,53,52,51 e
44,43,42,41

Uo: 7,2 VDC
Io: 7,3 mA
Po: 13,2 mW
Lo: 667 mH
Co: 13,5µF

Terminais:

44,43,42,41

Uo: 7,2 VDC
Io: 7,3 mA
Po: 13,2 mW
Lo: 667 mH
Co: 13,5µF

Terminais:

54,53,52,51

Uo: 7,2 VDC
Io: 7,3 mA
Po: 13,2 mW
Lo: 667 mH
Co: 13,5µF

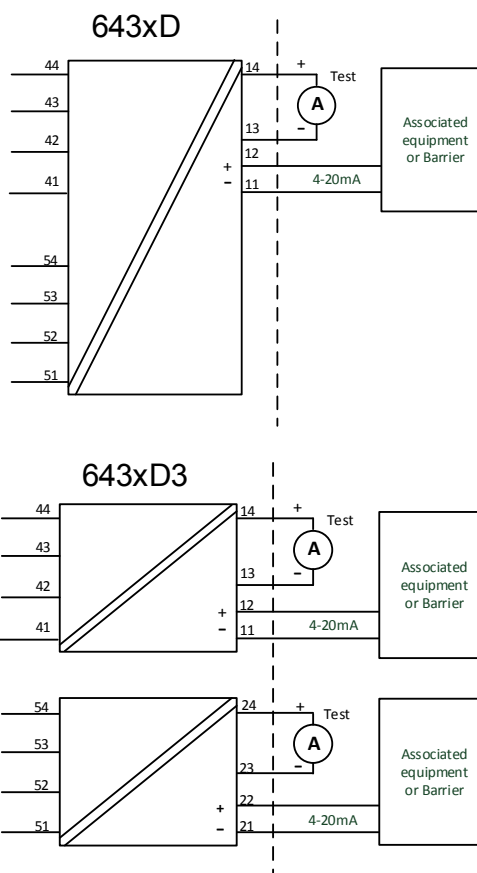

Instalação Ex ib

Área Classificada
Zone 0, 1, 2,
21, 22 and Ma

Área Classificada
Zone 1

Área Não Classificada

Terminais:
54,53,52,51 e
44,43,42,41

U_o: 7,2VDC
I_o: 7,3 mA
P_o: 13,2 mW
L_o: 667 mH
C_o: 13,5µF

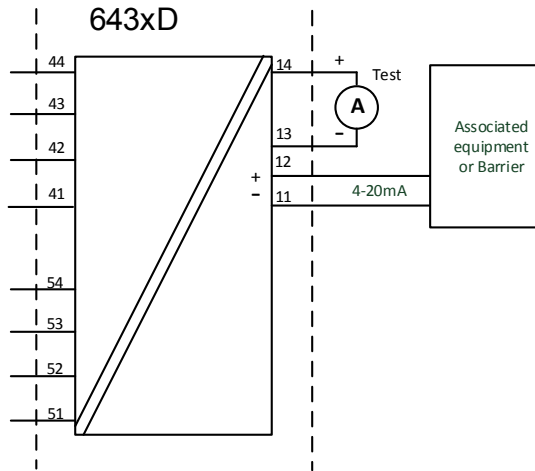

Terminais:
44,43,42,41

U_o: 7,2VDC
I_o: 7,3 mA
P_o: 13,2 mW
L_o: 667 mH
C_o: 13,5µF

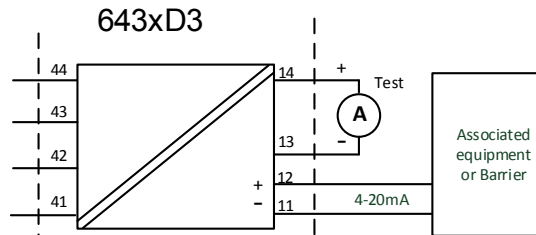

Terminais:
54,53,52,51

U_o: 7,2VDC
I_o: 7,3 mA
P_o: 13,2 mW
L_o: 667 mH
C_o: 13,5µF

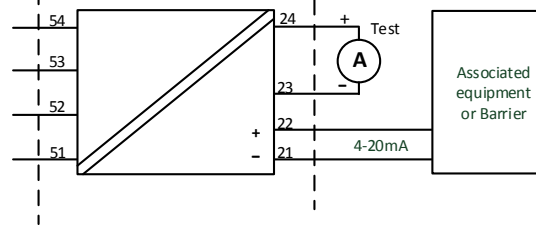

643xD1: Terminais: 11,12			
643xD2: Terminais: 11,12			
643xD3: Terminais: Ch1: 11,12 Ch2: 21,22			
Instalações Ex ia e Ex ib			
Ui: 30 VDC; li: 120 mA; Li: 0 µH; Ci: 1,0nF			
P _i por canal	Classe de temperatura	Faixas de Temperaturas	
		Entrada simples e dupla	Dois canais
900 mW	T6	+50 °C	+45 °C
	T5	+65 °C	+60 °C
	T4	+85 °C	+85 °C
750 mW	T6	+55 °C	+50 °C
	T5	+70 °C	+65 °C
	T4	+85 °C	+85 °C
610 mW	T6	+60 °C	+55 °C
	T5	+75 °C	+70 °C
	T4	+85 °C	+85 °C

Instruções Gerais de Instalação

O ano de fabricação pode ser obtido a partir dos dois primeiros dígitos do número de série. Se o invólucro for feito de materiais não metálicos ou de metal com uma camada de tinta mais espessa que 0,2 mm (grupo IIC) ou 2 mm (grupo IIB, IIA, I) ou qualquer espessura (grupo III), cargas eletrostáticas devem ser evitadas.

Para EPL Ga, se o invólucro for de alumínio, ele deverá ser instalado de forma que as fontes de ignição devido a faíscas de impacto e fricção sejam excluídas.

A distância entre os terminais, inclusive a parte nua dos fios, deve ser pelo menos 3 mm separada de qualquer metal aterrado.

Os pinos de teste permitem medir a corrente do loop diretamente, mantendo a integridade do loop. A energia deve estar conectada ao transmissor ao usar os pinos de teste. Para instalação em áreas classificadas, somente equipamentos de teste certificados podem ser utilizados.

Se o transmissor foi aplicado no tipo de proteção Ex ec, pode não ser aplicado posteriormente para segurança intrínseca.

O conector frontal e os pads de teste frontais fornecem um sinal de porta de extensão intrinsecamente seguro e só podem ser conectados a equipamentos dedicados da PRelectronics.

Aviso: Não conecte ou desconecte as fichas e as tomadas quando energizados.

Para instalação em uma atmosfera potencialmente explosiva de poeira, as seguintes instruções se aplicam:

O transmissor deve ser montado em um gabinete que ofereça um grau de proteção de pelo menos IP5X, de acordo com a ABNT NBR IEC60529. O gabinete deve ser adequado para a aplicação e instalado corretamente.

Os dispositivos de entrada de cabos e os elementos de supressão devem cumprir os mesmos requisitos.

A temperatura da superfície do invólucro externo é +20 K acima da temperatura ambiente, determinada sem camada de poeira.

Para instalações em Minas, as instruções abaixo se aplicam:

O transmissor deverá ser montado em um gabinete de metal que possibilita um grau mínimo de proteção IP54 de acordo com a ABNT NBR IEC60529

Gabinetes de Alumínio não são permitidos para instalações em Minas.

O gabinete deve ser adequado para a aplicação e instalado corretamente.

Os dispositivos de entrada de cabos e os elementos espaçadores devem satisfazer os mesmos requisitos

Instalações Ex ec / Ex ic

Para instalações seguras do 6431Axxx e 6437Axxx as seguintes instruções devem ser observadas

Notas Ex ec IIC T6...T4 Gc
Ex ic IIC T6...T4 Gc
Ex ic IIIC Dc

Área Classificada
Zone 2 and 22

Área Não Classificada

Terminais:

54,53,52,51 e
44,43,42,41

Uo: 7,2 VDC
Io: 7,3 mA
Po: 13,2 mW
Lo: 667 mH
Co: 13,5µF

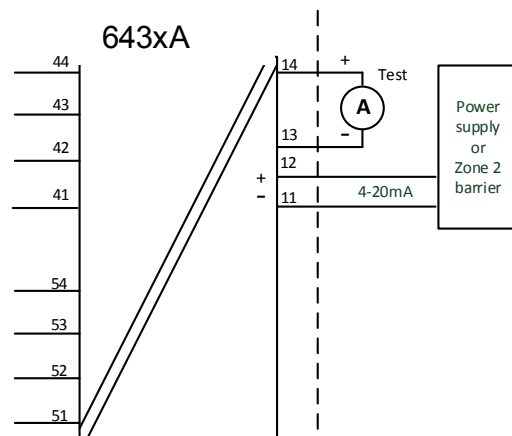

Terminais:

44,43,42,41

Uo: 7,2 VDC
Io: 7,3 mA
Po: 13,2 mW
Lo: 667 mH
Co: 13,5µF

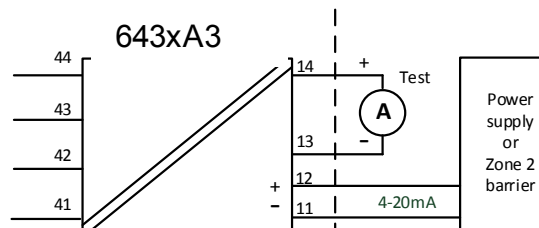

Terminais:

54,53,52,51

Uo: 7,2 VDC
Io: 7,3 mA
Po: 13,2 mW
Lo: 667 mH
Co: 135µF

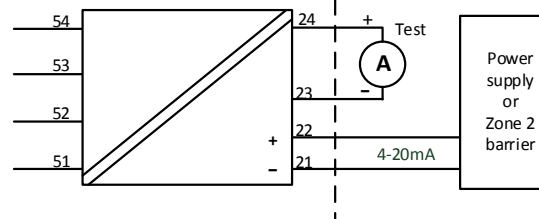

643xA1: Terminal 44 43,42,41	
643xA2: Terminal In1: 44 43,42,41	In2: 54 53,52,51
643xA3 : Terminal Ch1: 44 43,42,41	Ch2: 54 53,52,51
Ex ec	Ex ic
Vmax = 7,2VDC	Uo: 7,2 VDC; Io: 7,3 mA Po: 13,2 mW; Lo: 667 mH; Co: 13,5µF

643xA1: Terminais: 11,12					
643xA2: Terminais: 11,12					
643xA3: Terminais: Ch1: 11,12 Ch2: 21,22					
Circuito de alimentação / saída				Faixa de Temperatura	
Ex ec	Ex ic	Ex ic	Classe de temperatura	Entrada simples e dupla	Dois canais
	Li = 0 uH Ci = 1,0 nF	Ui= 48 VDC, Li = 0 uH, Ci = 1,0 nF			
Vmax= 37 VDC	Ui= 37 VDC	Pi= 851 mW por canal	T4	+85 °C	+85 °C
			T5	+70 °C	+65 °C
			T6	+55 °C	+50 °C
Vmax= 30 VDC	Ui= 30 VDC	Pi= 700 mW por canal	T4	+85 °C	+85 °C
			T5	+75 °C	+70 °C
			T6	+60 °C	+55 °C

Instruções gerais de instalação:

Se o invólucro for feito de materiais não metálicos, ou se for feito de metal com uma camada de tinta mais espessa que 0,2 mm (grupo IIC), ou 2 mm (grupo IIB, IIA, I) ou qualquer espessura (grupo III), cargas eletrostáticas devem ser evitadas.

Para uma temperatura ambiente $\geq 60^{\circ}\text{C}$, devem ser utilizados cabos resistentes ao calor com uma classificação de pelo menos 20 K acima da temperatura ambiente.

O gabinete deve ser adequado para a aplicação e instalado corretamente.

A distância entre terminais, fios inclusivos não isolados, deve ser separada por pelo menos 3 mm de qualquer metal aterrado.

A conexão TESTE, deve ser utilizado somente quando a área é segura, ou quando a fonte / circuito de saída e o medidor de corrente aplicado seja do tipo intrinsecamente seguro.

Aviso: Não conecte ou desconecte as fichas e as tomadas quando energizados.

Para instalações em uma atmosfera de gás potencialmente explosiva, as instruções abaixo e aplicarão:

O transmissor deve ser instalado em um gabinete que forneça um grau de proteção não inferior a IP54, de acordo com a ABNT NBR IEC 60079-0, adequado para a aplicação e corretamente instalado, por exemplo, em um gabinete que esteja no tipo de proteção Ex ec.

Além disso, a área dentro do gabinete deve ter grau de poluição 2 ou melhor, conforme definido na ABNT NBR IEC 60664-1.

Os dispositivos de entrada de cabos e os elementos de supressão devem cumprir os mesmos requisitos.

Para a instalação em uma atmosfera de poeira potencialmente explosiva, as seguintes instruções se aplicarão:

Para EPL Dc, a temperatura da superfície do invólucro externo é +20 K acima da temperatura ambiente, determinada sem camada de poeira.

Se o transmissor for fornecido com um sinal intrinsecamente seguro "ic" e fizer interface com um sinal intrinsecamente seguro "ic" (por exemplo, um dispositivo passivo), o transmissor deverá ser montado em um gabinete que forneça um grau de proteção de pelo menos IP54 de acordo com IEC 60079-0. Os dispositivos de entrada de cabos e os elementos de obturação devem cumprir os mesmos requisitos.

Se o transmissor for instalado em uma atmosfera explosiva que exija o uso de nível de proteção de equipamento Gc e aplicado no tipo de proteção Ex ec, o transmissor deverá ser montado em gabinete que forneça um grau de proteção de pelo menos IP54 de acordo com IEC 60079-0, e isso é adequado para o aplicativo e instalado corretamente. Os dispositivos de entrada de cabos e os elementos de obturação devem cumprir os mesmos requisitos.

Appendix A: Diagnostics overview

Incident Description	Description	LED reaction	Analog Output Reaction	NE-107 Class	User action	Error #
The device variable mapped to PV (and analog out put current) is beyond its operating limits.	Primary Value Out Of Limits	Flashing Red	Enters configured Value	Maintenance required	Reconnect or repair sensor	0
Any other device variable is beyond its operating limits.	Non-Primary Value Out Of Limits	Flashing Red	No impact	Maintenance required	Reconnect or repair sensor	1
The loop current has reached the Current Output Upper Limit (UL) or Output Lower Limit (LL) as configured with command #147, and is no longer corresponding to the PV value.	Loop Current Saturated	Flashing Red	Enters configured Value	Maintenance required	Reconnect or repair sensor	2
The analogue output current is being simulated or disabled.	Loop Current Fixed	Flashing Red	Enters configured Value	Function check	N.A.	3
The configuration has changed since this bit was last cleared (seen from same master type, Primary- or Secondary Master).	Configuration Changed	No Impact	No impact	N.A.	N.A.	6
A sensor error (broken/shorted sensor) is detected on Input 1	Primary Input 1 error	Flashing Red	Enters configured Value	Failure	Reconnect or repair sensor	10
A sensor error (broken/shorted sensor) is detected on Input 2. This is only possible if Input type 2 is <> "None"	Primary Input 2 error (only if Input 2 is enabled)	Flashing Red	Enters configured Value	Failure	Reconnect or repair sensor	11
A sensor error (broken/shorted sensor) is detected on the CJC measurement used for Input 1	CJC for Input 1 error (only if used)	Flashing Red	Enters configured Value	Failure	Reconnect or repair sensor	12
A sensor error (broken/shorted sensor) is detected on the CJC measurement used for Input 2	CJC for Input 2 error (only if used)	Flashing Red	Enters configured Value	Failure	Reconnect or repair sensor	13
The difference between measurements on Input 1 and Input 2 is outside the configured sensor drift limit	Dual Input: Sensor drift alarm (only if enabled)	Flashing Red	Enters configured Value	Failure	Reconnect or repair sensor	14
A sensor error (broken/shorted) is detected, backup sensor is in use	Dual Input: Backup sensor OK, main sensor error	No Impact	No impact	Maintenance required	Reconnect or repair sensor	15
A sensor error (broken/shorted) is detected on the backup sensor, no backup available	Dual Input: Backup sensor error, main sensor OK	No Impact	No impact	Maintenance required	Reconnect or repair sensor	16
Configuration is temporary invalid < 3 seconds, e.g. while downloading parameters	Configuration not supported by device	Flashing Red	Value is held (freeze)	Function check	N.A.	17
Configuration is temporary invalid > 3 seconds, e.g. if download is paused	Configuration not supported by device	Lights Red	Safe State	Failure	Correct and/or re-send the configuration	18
The device is operated outside its specified temperature range	Internal electronics temperature alarm	Flashing Red	No impact	Out of specification	Check operating temperature	19
The device is operated outside its specified temperature range in SIL mode	Internal electronics temperature alarm	Lights Red	Safe State	Failure	Check operating temperature	20
Power is applied but still too low	Minimum supply voltage not reached	Off	Safe State	Function check	Check power supply (at output terminals). If the error is persistant send in the device for repair	21
The device is transitioning to SIL mode, or have failed to do so	Attempting or failed to enter SIL mode	Lights Red	Safe State	Function check	The SIL configuration must be validated or normal operation must be re-selected	22
An unrecoverable error occurred in the internal communication to the Input CPU	Error in communication with Input CPU	Lights Red	Safe State	Failure	Reset or re-power the device. If the error is persistant send in the device for repair	23

Incident Description	Description	LED reaction	Analog Output Reaction	NE-107 Class	User action	Error #
An unrecoverable error occurred in the Input CPU	Input CPU reconfiguration failed	Lights Red	Safe State	Failure	Reset or re-power the device. If the error is persistent send in the device for repair	24
The device is operated below its specified voltage supply range	Supply voltage too low	Lights Red	Safe State	Failure	Check power supply (at output terminals). Reset or re-power the device. If the error is persistent send in the device for repair	25
The read back loop current differs from the calculated output current	Loop current read back error	Lights Red	Safe State	Failure	Check power supply (at output terminals). Reset or re-power the device. If the error is persistent send in the device for repair	26
The device is operated above its specified voltage supply range	Supply voltage too high	Lights Red	Safe State	Failure	Check power supply (at output terminals). Reset or re-power the device. If the error is persistent send in the device for repair	27
The configuration in the NVM has become inconsistent	Error in data verification after writing to EEPROM	Lights Red	Safe State	Failure	Correct and/or re-send the configuration. If the error is persistent send the device to repair	28
The configuration in the NVM has become inconsistent	CRC16 error in cyclic test of EEPROM	Lights Red	Safe State	Failure	Correct and/or re-send the configuration. If the error is persistent send the device to repair	29
An unrecoverable error occurred in the internal communication to the EEPROM	Error in EEPROM communication	Lights Red	Safe State	Failure	Reset or re-power the device. If the error is persistent send in the device for repair	30
An unrecoverable memory error occurred in the internal main CPU	CRC16 error in cyclic test of program code in FLASH	Lights Red	Safe State	Failure	Reset or re-power the device. If the error is persistent send in the device for repair	31
An exception error occurred in the main CPU program execution	Exception error during code execution	Lights Red	Safe State	Failure	Reset or re-power the device. If the error is persistent send in the device for repair	32
The main program was reset unintentionally due to a stuck up	Watchdog Reset Executed	Lights Red	Safe State	Failure	Correct and/or re-send the configuration. If the error is persistent send the device to repair	33
Sensor error is detected on the internal temperature sensor	Internal RTD sensor error	Lights Red	Safe State	Failure	Reset or re-power the device. If the error is persistent send in the device for repair	34
An unrecoverable memory error occurred in the internal main CPU	CRC16 error in cyclic test of safe-domain RAM contents	Lights Red	Safe State	Failure	Reset or re-power the device. If the error is persistent send in the device for repair	35
An exception error occurred in the main CPU program execution	Stack integrity error	Lights Red	Safe State	Failure	Reset or re-power the device. If the error is persistent send in the device for repair	36
An unrecoverable memory error occurred in the internal main CPU	CRC16 error in factory data in FLASH	Lights Red	Safe State	Failure	Reset or re-power the device. If the error is persistent send in the device for repair	37
An unrecoverable memory error occurred in the internal main CPU	RAM cell error	Lights Red	Safe State	Failure	Reset or re-power the device. If the error is persistent send in the device for repair	38
An unrecoverable memory error occurred in the internal main CPU	Safe domain RAM integrity error	Lights Red	Safe State	Failure	Reset or re-power the device. If the error is persistent send in the device for repair	39
An unrecoverable memory error occurred in the internal input CPU	CRC16 error in input CPU configuration	Lights Red	Safe State	Failure	Reset or re-power the device. If the error is persistent send in the device for repair	40

Incident Description	Description	LED reaction	Analog Output Reaction	NE-107 Class	User action	Error #
A critical measurement error is detected on internal voltage reference	Drift error, reference voltage FVR	Flashing Red	Safe State	Failure	Reconnect or repair sensor. If the error is persistent send in the device for repair	41
A critical measurement error is detected on internal voltage reference	Drift error, reference voltage VREF	Flashing Red	Safe State	Failure	Reconnect or repair sensor. If the error is persistent send in the device for repair	42
A critical measurement error is detected on Input 1	Drift error, primary Input 1	Flashing Red	Safe State	Failure	Reconnect or repair sensor. If the error is persistent send in the device for repair	43
A critical measurement error is detected on Input 2	Drift error, primary Input 2	Flashing Red	Safe State	Failure	Reconnect or repair sensor. If the error is persistent send in the device for repair	44
A critical measurement error is detected on the ground measurement	Drift error, ground voltage offset to terminal 3	Flashing Red	Safe State	Failure	Reconnect or repair sensor. If the error is persistent send in the device for repair	45
The device is in simulation mode and one or more of its Device Variables are not representative of the process	Device Variable Simulation Active	No Impact	No impact	N.A.	N.A.	46

文档更新记录

以下列表提供了有关本文档修订的说明。

版本号	日期	说明
100	2014	产品首发。
101	2018	TC 和 mV 输入的精度表已更新。 TC 示例的精度计算已更新。
102	2110	6437x3xx选项暂停。
103	2240	ATEX 和 IECEX 安装图更新。 添加了 UKCA。
104	2506	INMETRO 和 NEPSI 认证已更新 - Ex nA 更改为 Ex ec。 响应时间从 70 毫秒修正为 75 毫秒。

无论您身在何处， 我们始终在您身边

无论您身在何处，都将获得我们标志性红色模块的全力支持

我们所有的设备都提供权威的专家服务，且享受长达五年的质量保证。您购买的每款产品都将获得个性化的技术支持和指导，按时交货，保修期内免费维修，丰富的技术文档等服务。

我们的总部在丹麦，我们在世界各地设有办事处并在全球创建授权合作伙伴关系。我们能在全球范围内为您提供本地化

服务。这意味着我们总是伴随在您身边，并且非常了解当地市场。

我们致力于打造高客户满意度产品，并将 PERFORMANCE MADE SMARTER 这一理念传向世界。

了解更多有关我们的保修计划，或想与您所在地区的销售代表会面，请访问 prelectronics.com。

让 PERFORMANCE MADE SMARTER 助您一臂之力

PR electronics 是一家行业领先的、专注于使过程控制更加安全、可靠和高效的技术型公司。自 1974 年以来，我们一直致力于高精度-低功耗型核心技术的开发。秉承这种精神，我们不断地为产品设置新的标准，如此这般能够在客户的过程测量点与其过程控制系统之间进行通信、监控和连接。

我们的创新专利技术来源于大量的研发设施以及对客户需求和工艺过程的深刻理解。简约、专注、勇气、卓越是我们的座右铭。这指引着我们不断帮助一些世界上最大的公司实现更卓越的智能化 (PERFORMANCE MADE SMARTER)。