

PERFORMANCE
MADE
SMARTER

Product manual

6437

**2-wire HART 7
temperature transmitter**

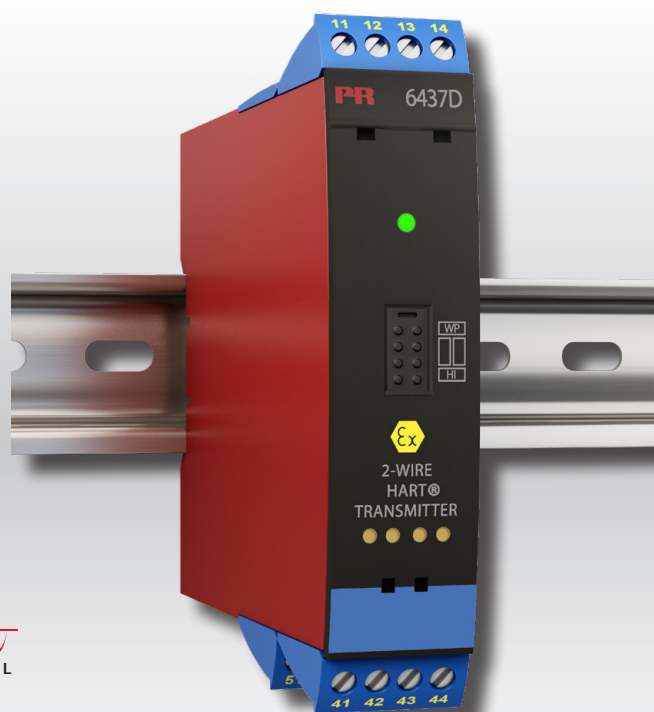

HART
COMMUNICATION PROTOCOL



TEMPERATURE | I.S. INTERFACES | COMMUNICATION INTERFACES | MULTIFUNCTIONAL | ISOLATION | DISPLAY

No. 6437V104-UK

Product version: 01.00.00-01.99.99

PR
electronics

6 Product Pillars

to meet your every need

Individually outstanding, unrivalled in combination

With our innovative, patented technologies, we make signal conditioning smarter and simpler. Our portfolio is composed of six product areas, where we offer a wide range of analog and digital devices covering over a thousand applications in industrial and factory automation. All our products comply with or surpass the highest industry standards, ensuring reliability in even the harshest of environments and have a 5-year warranty for greater peace of mind.

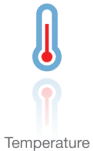

Our range of temperature transmitters and sensors provides the highest level of signal integrity from the measurement point to your control system. You can convert industrial process temperature signals to analog, bus or digital communications using a highly reliable point-to-point solution with a fast response time, automatic self-calibration, sensor error detection, low drift, and top EMC performance in any environment.



We deliver the safest signals by validating our products against the toughest safety standards. Through our commitment to innovation, we have made pioneering achievements in developing I.S. interfaces with SIL 2 Full Assessment that are both efficient and cost-effective. Our comprehensive range of analog and digital intrinsically safe isolation barriers offers multifunctional inputs and outputs, making PR an easy-to-implement site standard. Our backplanes further simplify large installations and provide seamless integration to standard DCS systems.



We provide inexpensive, easy-to-use, future-ready communication interfaces that can access your PR installed base of products. All the interfaces are detachable, have a built-in display for readout of process values and diagnostics, and can be configured via push-buttons. Product specific functionality includes communication via Modbus and Bluetooth and remote access using our PR Process Supervisor (PPS) application, available for iOS and Android.



Our unique range of single devices covering multiple applications is easily deployable as your site standard. Having one variant that applies to a broad range of applications can reduce your installation time and training, and greatly simplify spare parts management at your facilities. Our devices are designed for long-term signal accuracy, low power consumption, immunity to electrical noise and simple programming.



Our compact, fast, high-quality 6 mm isolators are based on microprocessor technology to provide exceptional performance and EMC-immunity for dedicated applications at a very low total cost of ownership. They can be stacked both vertically and horizontally with no air gap separation between units required.



Our display range is characterized by its flexibility and stability. The devices meet nearly every demand for display readout of process signals and have universal input and power supply capabilities. They provide a real-time measurement of your process value no matter the industry and are engineered to provide a user-friendly and reliable relay of information, even in demanding environments.

2-wire HART 7 temperature transmitter 6437

Table of contents

Application	4
Technical characteristics	4
Mounting / installation / programming	4
Applications	5
Order	6
Accessories	6
Electrical specifications	6
LED function	15
Jumpers	15
Test pins	16
HART commands	16
Advanced functions	17
Dynamic variable mapping	18
Overview of device variables	18
Write protection by software	19
Write protection by jumper	19
Changing the HART protocol version	19
SIL functionality	21
Connections	22
Block diagrams	23
Programming	25
Connection of transmitters in multidrop mode	26
ATEX Installation Drawing	27
IECEX Installation Drawing	33
CSA Installation Drawing	39
FM Installation Drawing	46
Instalação INMETRO	51
Appendix A: Diagnostics overview	57
Document history	60

2-wire HART 7 temperature transmitter 6437

- RTD, TC, potentiometer, linear resistance and bipolar mV input
- Single or dual input with sensor redundancy and drift detection
- Wide ambient operating temperature of -50 to +85°C
- Total accuracy from 0.014%
- 2.5 kVAC galvanic isolation
- Full assessment to IEC61508 : 2010 for use in SIL 2/3 applications

Application

- Temperature measurement of a wide range of TC and RTD types.
- Conversion of wide span linear resistance and potentiometer inputs to 4...20 mA.
- Conversion of bipolar mV signals to 4...20 mA.
- Integration into asset management schemes.
- Critical applications requiring superior accuracy and/or sensor redundancy and drift detection.

Technical characteristics

- True dual input transmitter, accepts the widest range of dual input combinations.
- Sensor redundancy - output automatically switches to secondary sensor in event of primary sensor failure, maintaining uptime.
- Sensor drift detection - alerts when sensor differential exceeds user-defined limits, for maintenance optimization.
- Dynamic variable mapping for process data in addition to the primary variable e.g. dual input features such as average, differential and min./max. tracking.
- Groundbreaking digital and analog signal accuracy over full input span and ambient conditions.
- Extensive sensor matching including Callendar Van Dusen and custom linearizations.
- Programmable input limits with runtime metering ensure maximum process traceability and sensor out of range protection.
- IEC 61508 : 2010 full assessment up to SIL 3 together with enhanced EMC Functional Safety testing to IEC 61236-3-1.
- Failure rates for 6437xxSx correspond to Performance Level "d" according to ISO-13849.
- Meets NAMUR NE21, NE43, NE44, NE89 and NE107 compliant diagnostics information.

Mounting / installation / programming

- DIN rail mounting with up to 84 inputs per meter.
- Configuration via PReset using PR5909 Loop Link /HART modem, or by Asset Management tool (e.g. Pactware, AMS, HART communicator) for which all relevant DD, eDD and DTM files are available
- The 6437A can be mounted in zone 2 and zone 22 / Class I, Division 2, Groups A, B, C, D.
- The 6437D can be mounted in zone 0, 1, 2 and zone 21, 22 including M1 / Class I, Division 1, Groups A, B, C, D.

Applications

Dual input

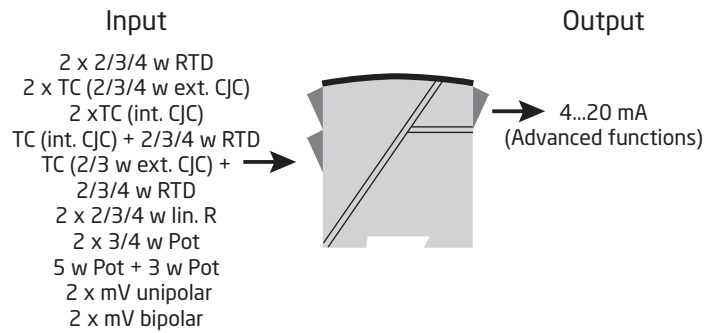

Single input

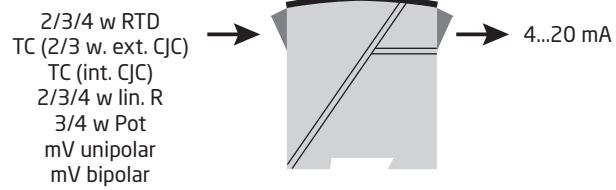

Order

Type	Version	Inputs	SIL approval	Marine approval
6437	General purpose : A	Single input (4 terminals) : 1	SIL : S	Yes : M
	Hazardous area : D	Dual input (8 terminals) : 2	No SIL : -	No : -

Accessories

5909	=	Loop Link USB interface and PReset Software
277	=	HART modem with USB connection
1125	=	Accredited calibration certificate, single input, 3 points
1126	=	Accredited calibration certificate, dual input, 3 points
1127	=	Accredited calibration certificate, single input, 5 points
1128	=	Accredited calibration certificate, dual input, 5 points

Electrical specifications

Environmental conditions:

Ambient operating temperature range:

Standard	-50°C to +85°C
SIL	-40°C to +80°C
Storage temperature	-50°C to +85°C
Calibration temperature	23...25°C
Humidity	< 99% RH (non-cond.)
Protection degree	IP20

Mechanical specifications:

Dimensions (HxWxD)	109 x 23.5 x 104 mm
Weight, single input / dual input / 2 channels	150 g / 160 g / 185 g
Max. wire size	0.13...2.08 mm ² / AWG 26...14 stranded wire
Screw terminal torque	0.5 Nm
Vibration	IEC 60068-2-6
2...25 Hz	±1.6 mm
25...100 Hz	±4 g

Common specifications:

Supply voltage, DC		
6437A	7.5*...48** VDC
6437D	7.5*...30** VDC
6437, EU-RO	8.3...33.6 VDC ±10%
Additional min. supply voltage when using test terminals	0.8 V
Max. internal power dissipation	≤ 850 mW per channel
Min. load resistance at > 37 V supply	(Supply voltage - 37) / 23 mA
Isolation voltage, test/operation:		
6437A	2.5 kVAC / 55 VAC
6437D	2.5 kVAC / 42 VAC
Polarity protection	All inputs and outputs
Write protection	Jumper or software
Warm-up time	< 5 min.
Start-up time	< 2.75 s
Programming	Loop Link & HART
Signal / noise ratio	> 60 dB
Long-term stability, better than	±0.05% of span / year ±0.18% of span / 5 years

* Note: Observe that the minimum supply voltage must be as measured at the terminals of the 6437, i.e. all external drops must be considered.

** Note: Make sure to protect the device from overvoltages by using a suitable power supply or by installing overvoltage protecting devices.

Response time 75 ms
 Programmable damping. 0...60 s
 Signal dynamics, input 24 bit
 Signal dynamics, output 18 bit
 Effect of supply voltage variation. < 0.005% of span / VDC

Input accuracies:

Basic values		
Input type	Basic accuracy	Temperature coefficient*
Pt10	$\leq \pm 0.8^{\circ}\text{C}$	$\leq \pm 0.020^{\circ}\text{C} / ^{\circ}\text{C}$
Pt20	$\leq \pm 0.4^{\circ}\text{C}$	$\leq \pm 0.010^{\circ}\text{C} / ^{\circ}\text{C}$
Pt50	$\leq \pm 0.16^{\circ}\text{C}$	$\leq \pm 0.004^{\circ}\text{C} / ^{\circ}\text{C}$
Pt100	$\leq \pm 0.04^{\circ}\text{C}$	$\leq \pm 0.002^{\circ}\text{C} / ^{\circ}\text{C}$
Pt200	$\leq \pm 0.08^{\circ}\text{C}$	$\leq \pm 0.002^{\circ}\text{C} / ^{\circ}\text{C}$
Pt500	$T_{\text{max.}} \leq 180^{\circ}\text{C}: \leq \pm 0.08^{\circ}\text{C}$ $T_{\text{max.}} > 180^{\circ}\text{C}: \leq \pm 0.16^{\circ}\text{C}$	$\leq \pm 0.002^{\circ}\text{C} / ^{\circ}\text{C}$
Pt1000	$\leq \pm 0.08^{\circ}\text{C}$	$\leq \pm 0.002^{\circ}\text{C} / ^{\circ}\text{C}$
Pt2000	$T_{\text{max.}} \leq 300^{\circ}\text{C}: \leq \pm 0.08^{\circ}\text{C}$ $T_{\text{max.}} > 300^{\circ}\text{C}: \leq \pm 0.40^{\circ}\text{C}$	$\leq \pm 0.002^{\circ}\text{C} / ^{\circ}\text{C}$
Pt10.000	$\leq \pm 0.16^{\circ}\text{C}$	$\leq \pm 0.002^{\circ}\text{C} / ^{\circ}\text{C}$
Pt x	The highest tolerance of the adjacent points	The highest coefficient of the adjacent points
Ni10	$\leq \pm 1.6^{\circ}\text{C}$	$\leq \pm 0.020^{\circ}\text{C} / ^{\circ}\text{C}$
Ni20	$\leq \pm 0.8^{\circ}\text{C}$	$\leq \pm 0.010^{\circ}\text{C} / ^{\circ}\text{C}$
Ni50	$\leq \pm 0.32^{\circ}\text{C}$	$\leq \pm 0.004^{\circ}\text{C} / ^{\circ}\text{C}$
Ni100	$\leq \pm 0.16^{\circ}\text{C}$	$\leq \pm 0.002^{\circ}\text{C} / ^{\circ}\text{C}$
Ni120	$\leq \pm 0.16^{\circ}\text{C}$	$\leq \pm 0.002^{\circ}\text{C} / ^{\circ}\text{C}$
Ni200	$\leq \pm 0.16^{\circ}\text{C}$	$\leq \pm 0.002^{\circ}\text{C} / ^{\circ}\text{C}$
Ni500	$\leq \pm 0.16^{\circ}\text{C}$	$\leq \pm 0.002^{\circ}\text{C} / ^{\circ}\text{C}$
Ni1000	$\leq \pm 0.16^{\circ}\text{C}$	$\leq \pm 0.002^{\circ}\text{C} / ^{\circ}\text{C}$
Ni2000	$\leq \pm 0.16^{\circ}\text{C}$	$\leq \pm 0.002^{\circ}\text{C} / ^{\circ}\text{C}$
Ni10000	$\leq \pm 0.32^{\circ}\text{C}$	$\leq \pm 0.002^{\circ}\text{C} / ^{\circ}\text{C}$
Ni x	The highest tolerance of the adjacent points	The highest coefficient of the adjacent points
Cu5	$\leq \pm 1.6^{\circ}\text{C}$	$\leq \pm 0.040^{\circ}\text{C} / ^{\circ}\text{C}$
Cu10	$\leq \pm 0.8^{\circ}\text{C}$	$\leq \pm 0.020^{\circ}\text{C} / ^{\circ}\text{C}$
Cu20	$\leq \pm 0.4^{\circ}\text{C}$	$\leq \pm 0.010^{\circ}\text{C} / ^{\circ}\text{C}$
Cu50	$\leq \pm 0.16^{\circ}\text{C}$	$\leq \pm 0.004^{\circ}\text{C} / ^{\circ}\text{C}$
Cu100	$\leq \pm 0.08^{\circ}\text{C}$	$\leq \pm 0.002^{\circ}\text{C} / ^{\circ}\text{C}$
Cu200	$\leq \pm 0.08^{\circ}\text{C}$	$\leq \pm 0.002^{\circ}\text{C} / ^{\circ}\text{C}$
Cu500	$\leq \pm 0.16^{\circ}\text{C}$	$\leq \pm 0.002^{\circ}\text{C} / ^{\circ}\text{C}$
Cu1000	$\leq \pm 0.08^{\circ}\text{C}$	$\leq \pm 0.002^{\circ}\text{C} / ^{\circ}\text{C}$
Cu x	The highest tolerance of the adjacent points	The highest coefficient of the adjacent points

* Input temperature coefficients are the listed values or [0.002% of reading] / °C, whichever is greater.

Basic values		
Input type	Basic accuracy	Temperature coefficient*
Lin. R: 0...400 Ω	$\leq \pm 40 \text{ m}\Omega$	$\leq \pm 2 \text{ m}\Omega / ^\circ\text{C}$
Lin. R: 0...100 kΩ	$\leq \pm 4 \Omega$	$\leq \pm 0.2 \Omega / ^\circ\text{C}$
Potentiometer: 0...100%	$< 0.05\%$	$< \pm 0.005\%$
mV: -20...100 mV	$\leq \pm 5 \mu\text{V}$ $\leq \pm 0.01\%$ of reading**	$\leq \pm 0.2 \mu\text{V} / ^\circ\text{C}$
mV: -100...1700 mV	$\leq \pm 0.1 \text{ mV}$ $\leq \pm 0.01\%$ of reading**	$\leq \pm 36 \mu\text{V} / ^\circ\text{C}$
mV: $\pm 800 \text{ mV}$	$\leq \pm 0.1 \text{ mV}$ $\leq \pm 0.01\%$ of reading**	$\leq \pm 32 \mu\text{V} / ^\circ\text{C}$
TC E	$\leq \pm 0.2^\circ\text{C}$ $\leq \pm 0.01\%$ of reading**	$\leq \pm 0.025^\circ\text{C} / ^\circ\text{C}$
TC J	$\leq \pm 0.25^\circ\text{C}$ $\leq \pm 0.01\%$ of reading**	$\leq \pm 0.025^\circ\text{C} / ^\circ\text{C}$
TJ K	$\leq \pm 0.25^\circ\text{C}$ $\leq \pm 0.01\%$ of reading**	$\leq \pm 0.025^\circ\text{C} / ^\circ\text{C}$
TC L	$\leq \pm 0.35^\circ\text{C}$ $\leq \pm 0.01\%$ of reading**	$\leq \pm 0.025^\circ\text{C} / ^\circ\text{C}$
TC N	$\leq \pm 0.4^\circ\text{C}$ $\leq \pm 0.01\%$ of reading**	$\leq \pm 0.025^\circ\text{C} / ^\circ\text{C}$
TC T	$\leq \pm 0.25^\circ\text{C}$ $\leq \pm 0.01\%$ of reading**	$\leq \pm 0.025^\circ\text{C} / ^\circ\text{C}$
TC U	$< 0^\circ\text{C}: \leq \pm 0.8^\circ\text{C}$ $\leq \pm 0.01\%$ of reading** $\geq 0^\circ\text{C}: \leq \pm 0.4^\circ\text{C}$ $\leq \pm 0.01\%$ of reading**	$\leq \pm 0.025^\circ\text{C} / ^\circ\text{C}$
TC Lr	$\leq \pm 0.2^\circ\text{C}$ $\leq \pm 0.01\%$ of reading**	$\leq \pm 0.1^\circ\text{C} / ^\circ\text{C}$
TC R	$< 200^\circ\text{C}: \leq \pm 0.5^\circ\text{C}$ $\leq \pm 0.01\%$ of reading** $\geq 200^\circ\text{C}: \leq \pm 1.0^\circ\text{C}$ $\leq \pm 0.01\%$ of reading**	$\leq \pm 0.1^\circ\text{C} / ^\circ\text{C}$
TC S	$< 200^\circ\text{C}: \leq \pm 0.5^\circ\text{C}$ $\leq \pm 0.01\%$ of reading** $\geq 200^\circ\text{C}: \leq \pm 1.0^\circ\text{C}$ $\leq \pm 0.01\%$ of reading**	$\leq \pm 0.1^\circ\text{C} / ^\circ\text{C}$
TC W3	$\leq \pm 0.6^\circ\text{C}$ $\leq \pm 0.01\%$ of reading**	$\leq \pm 0.1^\circ\text{C} / ^\circ\text{C}$
TC W5	$\leq \pm 0.4^\circ\text{C}$ $\leq \pm 0.01\%$ of reading**	$\leq \pm 0.1^\circ\text{C} / ^\circ\text{C}$

* Input temperature coefficients are the listed values or $[0.002\% \text{ of reading}] / ^\circ\text{C}$, whichever is greater.

** Gain deviation.

Basic values		
Input type	Basic accuracy	Temperature coefficient*
TC type: B ¹	$\leq \pm 1^{\circ}\text{C}$ $\leq \pm 0.01\%$ of reading**	$\leq \pm 0.1^{\circ}\text{C} / ^{\circ}\text{C}$
TC type: B ²	$\leq \pm 3^{\circ}\text{C}$ $\leq \pm 0.01\%$ of reading**	$\leq \pm 0.1^{\circ}\text{C} / ^{\circ}\text{C}$
TC type: B ³	$\leq \pm 8^{\circ}\text{C}$ $\leq \pm 0.01\%$ of reading**	$\leq \pm 0.8^{\circ}\text{C} / ^{\circ}\text{C}$
TC type: B ⁴	not specified	not specified
CJC (internal)	$< \pm 0.5^{\circ}\text{C}$	Included in basic accuracy
CJC (external)	$\leq \pm 0.08^{\circ}\text{C}$	$\leq \pm 0.002^{\circ}\text{C} / ^{\circ}\text{C}$

* Input temperature coefficients are the listed values or [0.002% of reading] / °C, whichever is greater.

** Gain deviation.

TC B¹ accuracy specification range > 400°C

TC B² accuracy specification range > 160°C < 400°C

TC B³ accuracy specification range > 85°C < 160°C

TC B⁴ accuracy specification range < 85°C

Output accuracies:

Basic values		
Output type	Basic accuracy	Temperature coefficient
Average measurement	Average of input 1 and 2 accuracy	Average of input 1 and 2 temperature coefficient
Differential measurement	Sum of input 1 and 2 accuracy	Sum of input 1 and 2 temperature coefficient
Analog output	$\leq \pm 1.6\mu\text{A}$ (0.01% of full output span)	$\leq \pm 0.48\mu\text{A} / \text{K}$ ($\leq \pm 0.003\%$ of full output span / K)

Accuracy calculation examples:

Example: Pt100 sensor, configured from -200°C to +850°C:

$$\text{Pt100}_{\text{Basic Accuracy}} = 0.04^{\circ}\text{C}$$

$$\text{Output}_{\text{Analog Accuracy}} = 0.0016 \text{ mA}$$

$$\text{Total}_{\text{Accuracy (mA)}} = \frac{\text{Basic}_{\text{Accuracy}}}{\text{Configured_Span}_{\text{INPUT}}} \times 16.0 \text{ mA} + \text{Output}_{\text{Analog Accuracy}}$$

$$\text{Total}_{\text{Accuracy (mA)}} = \frac{0.04^{\circ}\text{C}}{850^{\circ}\text{C} - (-200^{\circ}\text{C})} \times 16.0 \text{ mA} + 0.0016 \text{ mA} = \underline{0.0022 \text{ mA}}$$

$$\text{Total}_{\text{Accuracy (\%)}} = \frac{\text{Total}_{\text{Accuracy (mA)}}}{16.0 \text{ mA}} \times 100\%$$

$$\text{Total}_{\text{Accuracy (\%)}} = \frac{0.0022 \text{ mA}}{16.0 \text{ mA}} \times 100\% = \underline{0.01381\%}$$

Example: Type K TC, internal CJC, measured reading of 400°C, span 0...400°C:

$$\text{Type K TC}_{\text{Basic Accuracy}} = 0.25^{\circ}\text{C}$$

$$\text{Output}_{\text{Analog Accuracy}} = 0.0016 \text{ mA}$$

$$\text{Total}_{\text{Accuracy (mA)}} = \frac{\text{Basic}_{\text{Accuracy}} + \text{Int. CJC} + (\text{Gain Deviation} \times \text{Measured Reading})}{\text{Configured_Span}_{\text{INPUT}}} \times 16.0 \text{ mA} + \text{Output}_{\text{Analog Accuracy}}$$

$$\text{Total}_{\text{Accuracy (mA)}} = \frac{0.25^{\circ}\text{C} + 0.5^{\circ}\text{C} + (0.0001 \times 400)}{400^{\circ}\text{C}} \times 16.0 \text{ mA} + 0.0016 \text{ mA} = \underline{0.0332 \text{ mA}}$$

$$\text{Total}_{\text{Accuracy (\%)}} = \frac{\text{Total}_{\text{Accuracy (mA)}}}{16.0 \text{ mA}} \times 100\%$$

$$\text{Total}_{\text{Accuracy (\%)}} = \frac{0.0332 \text{ mA}}{16.0 \text{ mA}} \times 100\% = \underline{0.2075\%}$$

Example: Type K TC, external CJC Pt1000, measured reading of 400°C, span 0...400°C:

$$\text{Type K TC}_{\text{Basic Accuracy}} = 0.25^{\circ}\text{C}$$

$$\text{Output}_{\text{Analog Accuracy}} = 0.0016 \text{ mA}$$

$$\text{Total}_{\text{Accuracy (mA)}} = \frac{\text{Basic}_{\text{Accuracy}} + \text{Ext. CJC} + (\text{Gain Deviation} \times \text{Measured Reading})}{\text{Configured_Span}_{\text{INPUT}}} \times 16.0 \text{ mA} + \text{Output}_{\text{Analog Accuracy}}$$

$$\text{Total}_{\text{Accuracy (mA)}} = \frac{0.25^{\circ}\text{C} + 0.08^{\circ}\text{C} + (0.0001 \times 400)}{400^{\circ}\text{C}} \times 16.0 \text{ mA} + 0.0016 \text{ mA} = \underline{0.0164 \text{ mA}}$$

$$\text{Total}_{\text{Accuracy (\%)}} = \frac{\text{Total}_{\text{Accuracy (mA)}}}{16.0 \text{ mA}} \times 100\%$$

$$\text{Total}_{\text{Accuracy (\%)}} = \frac{0.0164 \text{ mA}}{16.0 \text{ mA}} \times 100\% = \underline{0.1025\%}$$

Example accuracy calculations are based on factory calibration ambient temperature, and do not take into account other potential sources of inaccuracy, e.g. power supply effect, ambient temperature fluctuation etc. which must also be considered.

EMC - immunity influence.	< ±0.1% of span
Extended EMC immunity: NAMUR NE 21, A criterion, burst	< ±1% of span

Input specifications:

RTD input types:

RTD type	Standard	Min. value	Max. value	α	Min. span
Pt10...10.000	IEC 60751	-200°C	+850°C	0.003851	10°C
	JIS C 1604-8	-200°C	+649 °C	0.003916	10°C
	GOST 6651-2009	-200°C	+850°C	0.003910	10°C
	Callendar Van Dusen	-200°C	+850°C	-----	10°C
Ni10...10.000	DIN 43760-1987	-60°C	+250°C	0.006180	10°C
	GOST 6651-2009 / OIML R84:2003	-60°C	+180°C	0.006170	10°C
Cu5...1000	Edison Copper Winding No. 15	-200°C	+260°C	0.004270	100°C
	GOST 6651-2009 / OIML R84:2003	-180°C	+200°C	0.004280	100°C
	GOST 6651-94	-50°C	+200°C	0.004260	100°C

- Connection type 2-, 3- and 4-wire
- Cable resistance per wire (max.). 50 Ω
- Sensor current < 0.15 mA
- Effect of sensor cable resistance (3-/4-wire) < 0.002 Ω / Ω
- Sensor cable, wire-wire capacitance Max. 30 nF (Pt1000 & Pt10000 IEC and JIS + Ni1000 & Ni10000)
Max. 50 nF (others than above)
- Sensor error detection, programmable None, Shorted, Broken, Shorted or Broken

	NOTE: Regardless of the sensor error detection configuration, shorted sensor error detection will be disabled if the lower limit for the configured sensor type is lower than the constant detection limit for shorted sensor.
-------------------------------------------------------------------------------------	---------------------------------------------------------------------------------------------------------------------------------------------------------------------------------------------------------------------------------------

- Detection limit for shorted sensor 15 Ω
- Sensor error detection time (RTD element) \leq 70 ms
- Sensor error detection time (for 3rd and 4th wire) \leq 2000 ms

TC input types:

Type	Min. temperature	Max. temperature	Min. span	Standard
B	0 (85)°C	+1820°C	100°C	IEC 60584-1
E	-200°C	+1000°C	50°C	IEC 60584-1
J	-100°C	+1200°C	50°C	IEC 60584-1
K	-180°C	+1372°C	50°C	IEC 60584-1
L	-200°C	+900°C	50°C	DIN 43710
Lr	-200°C	+800°C	50°C	GOST 3044-84
N	-180°C	+1300°C	50°C	IEC 60584-1
R	-50°C	+1760°C	100°C	IEC 60584-1
S	-50°C	+1760°C	100°C	IEC 60584-1
T	-200°C	+400°C	50°C	IEC 60584-1
U	-200°C	+600°C	50°C	DIN 43710
W3	0°C	+2300°C	100°C	ASTM E988-96
W5	0°C	+2300°C	100°C	ASTM E988-96

- Cold junction compensation (CJC):
- Constant, internal or external via a Pt100 or Ni100 sensor
 - Internal CJC temperature range -50°C to +100°C
 - External CJC connection. 2, 3 or 4-wire (4-wire only for dual input device)
 - External CJC cable resistance per wire (for 3- and 4-wire connections). 50 Ω
 - Effect of CJC cable resistance (for 3- and 4-wire connections) < 0.002 Ω / Ω
 - External CJC sensor current. < 0.15 mA

External CJC temperature range	-50°C to +135°C
CJC Sensor cable, wire-wire capacitance	Max. 50 nF
Maximum total cable resistance	Max. 10 kΩ
Sensor cable, wire-wire capacitance	Max. 50 nF
Sensor error detection, programmable	None, Shorted, Broken, Shorted or broken

	Shorted sensor error detection only applies to CJC sensor.
----------------------------------------------------------------------------------	------------------------------------------------------------

Sensor error detection time (TC element)	≤ 70 ms
Sensor error detection time, external CJC (for 3 rd and 4 th wire)	≤ 2000 ms

Linear resistance input:

Input range	0 Ω...100 kΩ
Min. span	25 Ω
Connection type	2-, 3- or 4-wire
Cable resistance per wire (max.)	50 Ω
Sensor current	< 0.15 mA
Effect of sensor cable resistance (3- / 4-wire)	< 0.002 Ω / Ω
Sensor cable, wire-wire capacitance	Max. 30 nF (Lin. R > 400 Ω) Max. 50 nF (Lin. R ≤ 400 Ω)
Sensor error detection, programmable	None, Broken

Potentiometer input:

Potentiometer	10 Ω...100 kΩ
Input range	0...100%
Min. span	10%
Connection type	3-, 4- or 5-wire (5-wire only for dual input device)
Cable resistance per wire (max.)	50 Ω
Sensor current	< 0.15 mA
Effect of sensor cable resistance (4- / 5-wire)	< 0.002 Ω / Ω
Sensor cable, wire-wire capacitance	Max. 30 nF (Potentiometer > 400 Ω) Max. 50 nF (Potentiometer ≤ 400 Ω)
Sensor error detection, programmable	None, Shorted, Broken, Shorted or Broken

	NOTE: Regardless of the sensor error detection configuration, shorted sensor error detection will be disabled if the configured potentiometer size is lower than the constant detection limit for shorted sensor.
------------------------------------------------------------------------------------	-------------------------------------------------------------------------------------------------------------------------------------------------------------------------------------------------------------------

Detection limit for shorted sensor	15 Ω
Sensor error detection time, wiper arm	≤ 70 ms (no shorted sensor detection)
Sensor error detection time, element	≤ 2000 ms
Sensor error detection time (4 th and 5 th wire)	≤ 2000 ms

mV input:

Measurement range	-800...+800 mV (bipolar) -100 to 1700 mV
Min. span	2.5 mV
Input resistance	10 MΩ
Sensor cable, wire-wire capacitance	Max. 30 nF (input range: -100...1700 mV) Max. 50 nF (input range: -20...100 mV)
Sensor error detection, programmable	None, Broken
Sensor error detection time	≤ 70 ms

Output specifications and HART:

Normal range, programmable	3.8...20.5 / 20.5...3.8 mA
Extended range (output limits), programmable	3.5...23 / 23...3.5 mA
Updating time	10 ms
Load (@ current output)	≤ (V _{supply} - 7.5) / 0.023 [Ω]
Load stability	< 0.01% of span / 100 Ω

Of span = Of the presently selected range

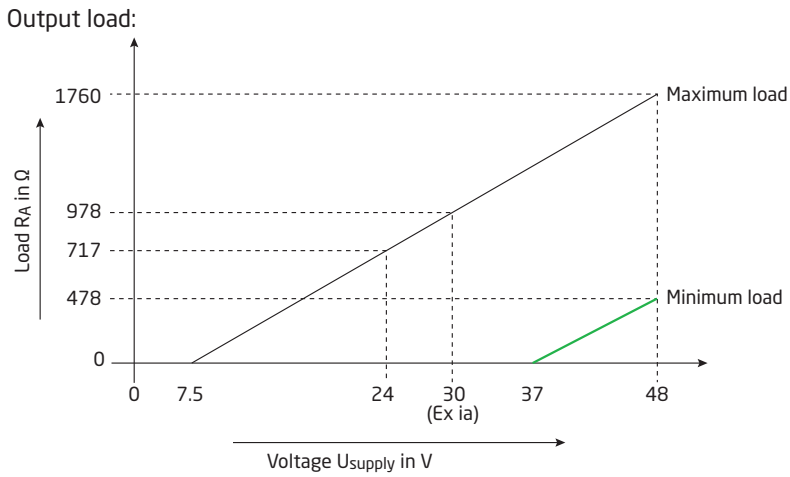

- Sensor error indication, programmable 3.5...23 mA
(shorted sensor error detection is ignored at TC and mV input)
- NAMUR NE43 Upscale > 21 mA
- NAMUR NE43 Downscale. < 3.6 mA
- HART protocol revisions. HART 7 and HART 5

Programmable input/output limits:

- Error current Enable / disable
- Set error current 3.5 mA...23 mA

Programmable input and current output limits are available to increase system safety and integrity.

Input:

When the input signal exceeds either of the programmable lower and upper limits, the device will output a user defined error current. Setting input limits ensures that any out of range measurements can be uniquely identified and flagged via the transmitter output, resulting in improved asset and material protection e.g. thermal runaway of a reaction process can be mitigated.

Example:

- Pt100 input ranged 100°C to 400°C
- Input limits set to Upper = +650°C, Lower = -150°C
- Error current set to 3.5 mA
- Output limits set to Upper = 20.5 mA, Lower = 3.8 mA

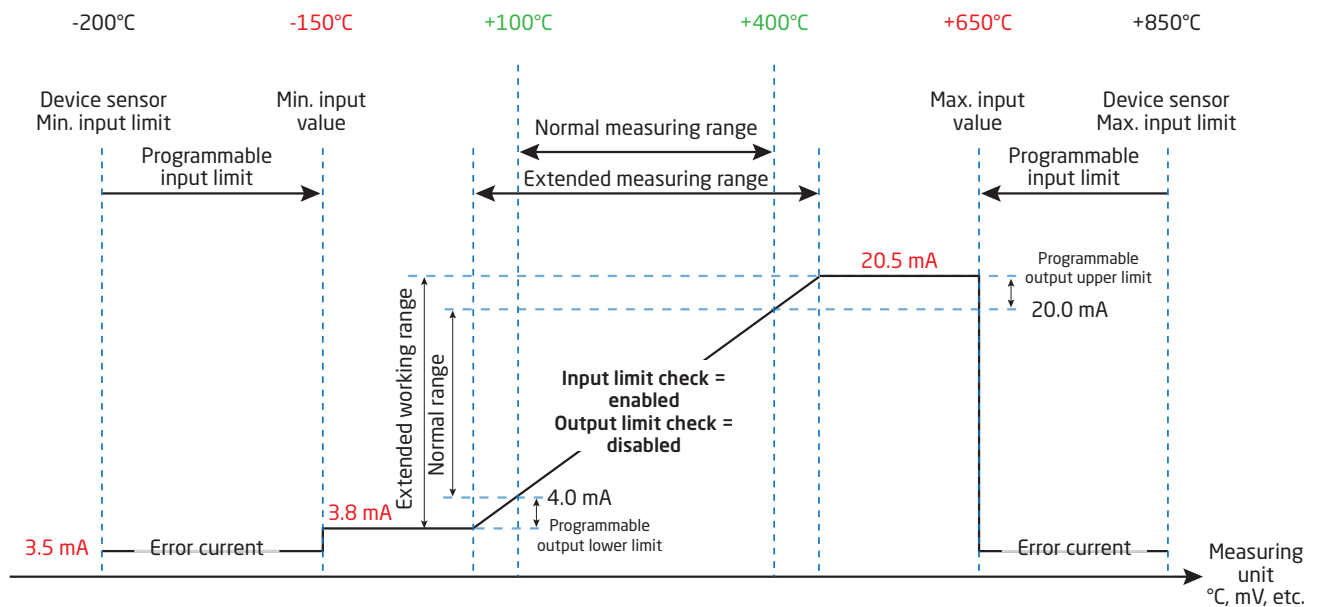

Output:

When the current output exceeds either of the programmable upper and lower limits, the device will output a user defined error current.

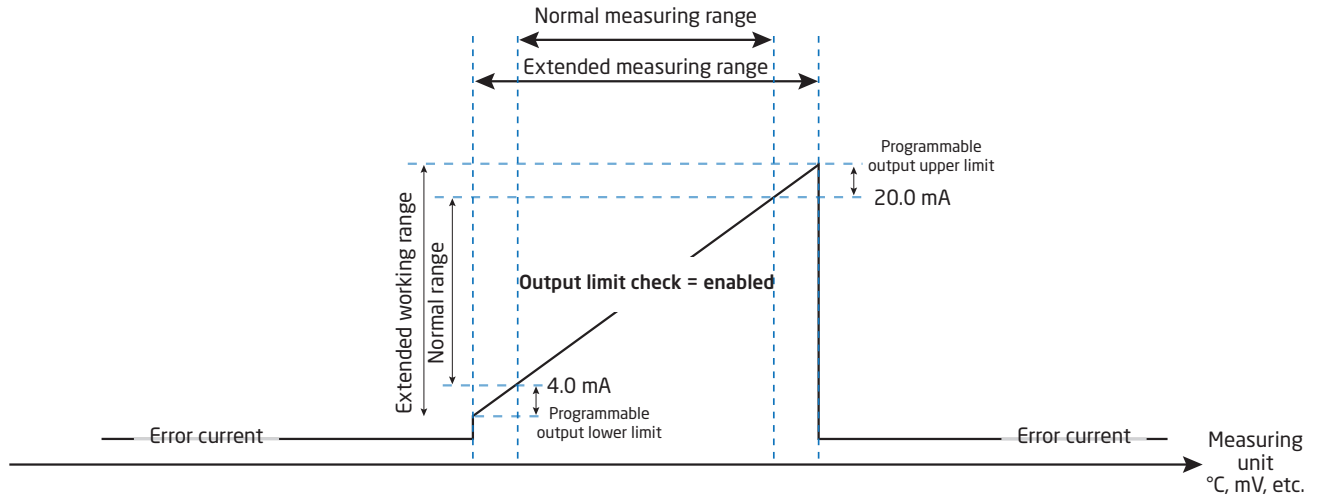

Observed authority requirements:

EMC	2014/30/EU & UK SI 2016/1091
ATEX	2014/34/EU & UK SI 2016/1107
RoHS	2011/65/EU & UK SI 2012/3032
EAC	TR-CU 020/2011
EAC Ex	TR-CU 012/2011

Approvals:

Ex / I.S.:

ATEX	
6437A	DEKRA 18ATEX0135X
6437D	DEKRA 16ATEX0047X
IECEX	IECEX DEK. 16.0029X
c FM us	FM16CA0146X / FM16US0287X
c CSA us	16.70066266
INMETRO	DEKRA 23.0002X
NEPSI	GYJ23.1253X
EAC Ex	RU C-DK.ПБ98.В.00192

Marine approval:



EU RO Mutual Recognition Type Approval	MRA0000023
--------------------------------------------------	------------

Functional safety:

SIL2 Certified & Fully Assessed acc. to IEC 61508 : 2010
 SFF > 93% - type B component
 SIL3 Applicable through redundant structure (HFT=0; 1oo2)
 FMEDA report - www.prelectronics.com

LED function

Onboard LED indicates faults according to NAMUR NE44 and NE107.

Condition	Green / red LED
Device OK	Constant 
No supply	OFF
Indication of faults independent of the device, e.g. wire break, sensor short circuit, violation of input or output limits	Flashing 
Device error	Constant 

For detailed device diagnostic behaviours and NE107 messaging, see Appendix A on page 57.

Jumpers

The 6437 have two front jumpers - one jumper to enable Write Protection and one jumper to select the output current at Safe State to go above 21 mA as specified in NAMUR NE43.

If the jumper is not inserted, the output current at Safe State will go lower than 3.6 mA as specified in NAMUR NE43.

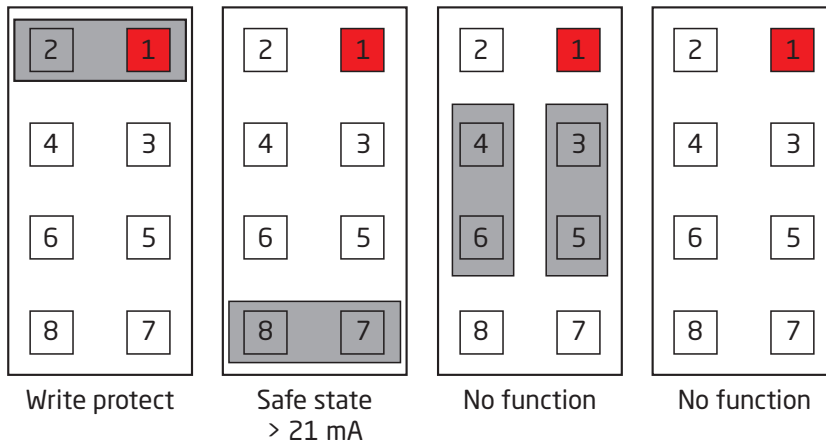

Test pins

The test pins allow measurement of loop current directly while maintaining loop integrity. Power must be connected to the transmitter when using the test pins.

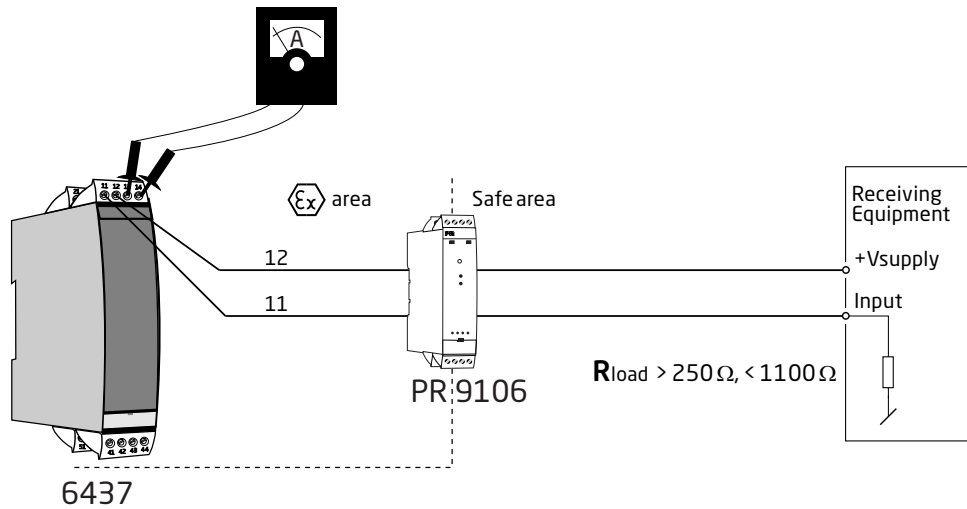

Warning!

For hazardous area installation, only certified test equipment may be used.

HART commands

For definitions and further information on HART commands for the 6437 please consult the 6437 HART Field Device Specification.

Advanced functions

Function	Description									
Differential	Analog output signal is proportional to the difference between input 1 and input 2 measurements. <i>Analog output = Input 1 - Input 2 or Input 2 - Input 1 or Input 2 - Input 1 </i>									
Average measurement	Analog output signal is proportional to the average of input 1 and input 2 measurements. <i>Analog output = 0.5 * (Input 1 + Input 2)</i>									
Max.	Analog output is proportional to the input with the highest value. <i>IF (Input 1 > Input 2) THEN AnalogOutput = Input 1 ELSE AnalogOutput = Input 2</i>									
Min.	Analog output is proportional to the input with the lowest value. <i>IF (Input 1 < Input 2) THEN AnalogOutput = Input 1 ELSE AnalogOutput = Input 2</i>									
Sensor drift	If the differential between input 1 and input 2 measured values exceed a predefined limit then a sensor drift error is indicated. <i>IF ABS (Input 1 - Input 2) > SensorDriftLimit THEN IndicateSensor-DriftError</i>									
Redundancy (Hot Backup)	Analog output is proportional to input 1 as long as no error is detected and input is within user-defined limits. If sensor error on input 1 is detected or if sensor 1 value is outside user-defined limits, analog output then becomes proportional to input 2 and a warning indication is generated. <i>IF (NoSensorErrorOnInput1 AND Input1InsideLimits) THEN AnalogOutput = Input 1 ELSE IF (NoSensorErrorOnInput2 AND Input2InsideLimits) THEN AnalogOutput = Input 2</i>									
Customized linearization - Polynomial Type	Supports polynomial linearization up to 5 segments, each with up to 4 th order polynomials.									
Customized linearization - Callendar Van Dusen	Supports direct entry of CVD constants.									
Customized linearization - Table linearization	Supports table linearization with up to 60 in/out values.									
Customized linearization - 2 nd order spline linearization	Supports 2 nd order spline linearization with up to 40 output values.									
Runtime meter - transmitter electronics	Recording of internal transmitter temperatures during operation, logging time spent in each of 9 fixed sub temperature ranges. <table border="1" style="margin-left: auto; margin-right: auto;"> <tbody> <tr><td style="text-align: center;">< -50°C</td></tr> <tr><td style="text-align: center;">-50...-30°C</td></tr> <tr><td style="text-align: center;">-30...-10°C</td></tr> <tr><td style="text-align: center;">-10...+10°C</td></tr> <tr><td style="text-align: center;">+10...+30°C</td></tr> <tr><td style="text-align: center;">+30...+50°C</td></tr> <tr><td style="text-align: center;">+50...+70°C</td></tr> <tr><td style="text-align: center;">+70...+85°C</td></tr> <tr><td style="text-align: center;">>85°C</td></tr> </tbody> </table>	< -50°C	-50...-30°C	-30...-10°C	-10...+10°C	+10...+30°C	+30...+50°C	+50...+70°C	+70...+85°C	>85°C
< -50°C										
-50...-30°C										
-30...-10°C										
-10...+10°C										
+10...+30°C										
+30...+50°C										
+50...+70°C										
+70...+85°C										
>85°C										
Runtime meter - inputs	Recording of input measurement values during operation, logging time spent in each of 9 fixed sub input ranges. Subranges are defined individually for each input type.									
Slave pointer - transmitter electronics	Recording of min./max. internal transmitter temperature for device's complete lifetime.									
Slave pointer - inputs	Recording of min./max. values for input/s measurements is saved. Values are reset when measurement configuration is changed.									

Dynamic variable mapping

Four dynamic variables are supported, PV, SV, TV and QV.

Using HART commands, these may be assigned to any Device Variable (DV 0 - 15) in any combination.

The device variable mapped to PV controls the loop current.

Device Variables	
DV0	Input 1 (temperature, voltage, resistance...)
DV1	Input 2 (temperature, voltage, resistance...)
DV2	CJC 1, input 1 CJC temperature, only valid if input 1 is a TC input
DV3	CJC 2, input 2 CJC temperature, only valid if input 2 is a TC input
DV4	Average input 1 and input 2
DV5	Difference input 1 - input 2
DV6	Difference input 2 - input 1
DV7	Absolute difference (input 1 - input 2)
DV8	Minimum (input 1, input 2)
DV9	Maximum (input 1, input 2)
DV10	Input 1 with input 2 as backup
DV11	Input 2 with input 1 as backup
DV12	Average input 1 and 2, with both as backup
DV13	Minimum of input 1 and 2, with both as backup
DV14	Maximum of input 1 and 2, with both as backup
DV15	Electronics temperature

Overview of device variables

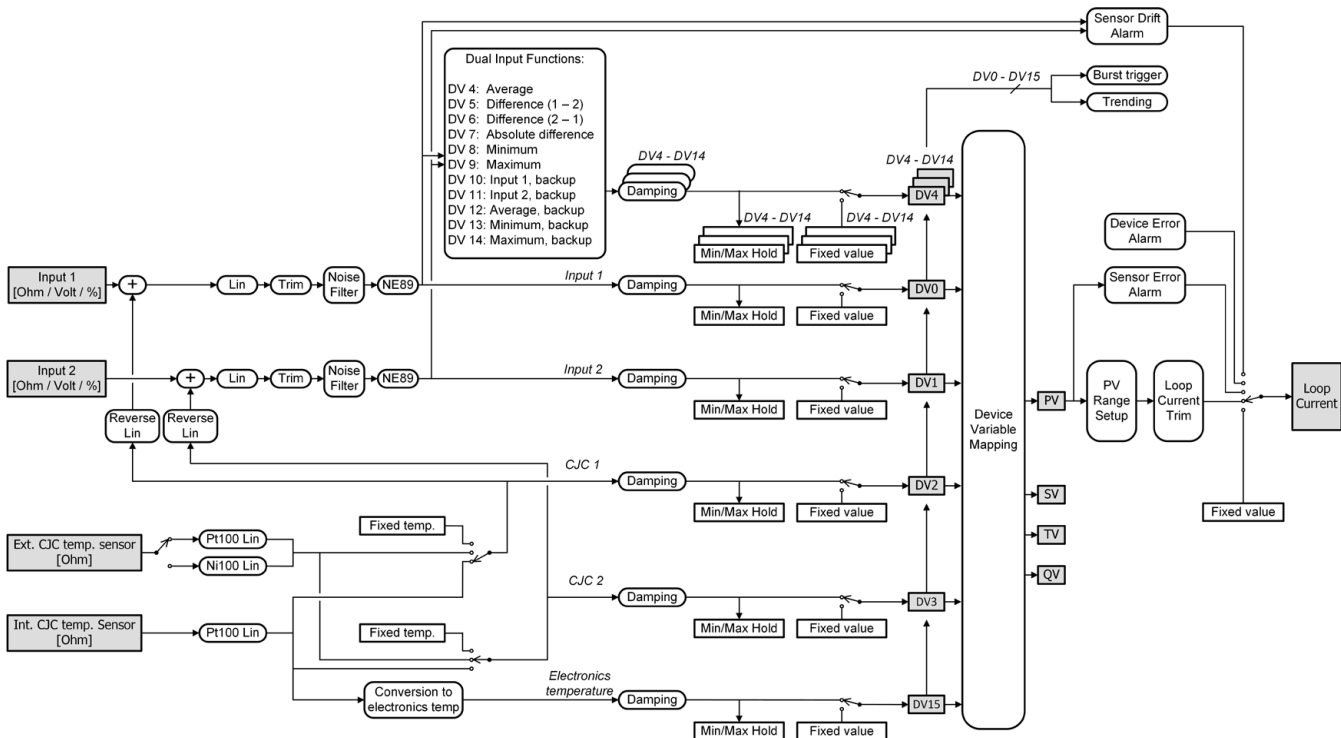

Write protection by software

The Default Active Password when the device leaves the factory is '*****'; this value can be changed by the user. If the Active Password is not known, please contact PR electronics support - www.prelectronics.com/contact. When changing the password, use only Latin-1 characters that can be entered and displayed on any terminal.

When write protection is enabled, no "write" commands are accepted regardless of the "Write Protect" Hardware Jumper position.

Write protection by jumper

If a hardware jumper is set in position "Write Protect", no "write" commands are accepted regardless if disabled by software.

Changing the HART protocol version

It is possible to change the unit's HART protocol revision by using the PReset software and a PR 5909 Loop Link interface or a HART interface.

Other HART configuration tools like a handheld HART terminal may also be used.

Procedure for using a HART hand-held terminal to change the 6437 from HART 7 to HART 5 and vice versa:

Change the 6437 from HART 7 to HART 5:

1. After entering the device menu (or after pressing home) the online menu is shown
2. Select **Device Setup** and press right arrow key (or simply press 7)
3. Select **Diagnostics/Service** and press right arrow key (or simply press 3)
4. Select **Write Protection** and press right arrow key (or simply press 6)
5. Select **Change to HART 5** and press right arrow key (or simply press 3)
6. When display says "Are you sure you want to change protocol to HART 5?" press OK
7. Enter the correct active password, default is "*****" (eight stars), and press OK
8. When the display says "Device is now in HART 5 mode" press OK and then Exit to go offline and rescan for new devices.
9. The device will now appear as being a 6437 (HART 5) device, select it to enter the online menu again

NOTE! After changing to HART 5, the configuration will be reset to the factory default.

The quick key sequence from the online menu is: **7, 3, 6, 3, OK, OK, OK, Exit.**

To change the device back to HART 7, just follow the same procedure as above, except **Change to HART 7** must be selected in step 5.

When changing back to HART 7, the configuration remains unchanged.

Procedure for using the PReset software and 5909 Loop Link or HART communication interface to change the 6437 from HART 7 to HART 5 and vice versa:

Switching from HART 7 to HART 5

Select the 6437 product and click the "HART" tab.

Click "Device Password / Write Protection / Protocol..." and select "Change protocol to HART 5" in the pop-up window, then acknowledge by pressing OK.

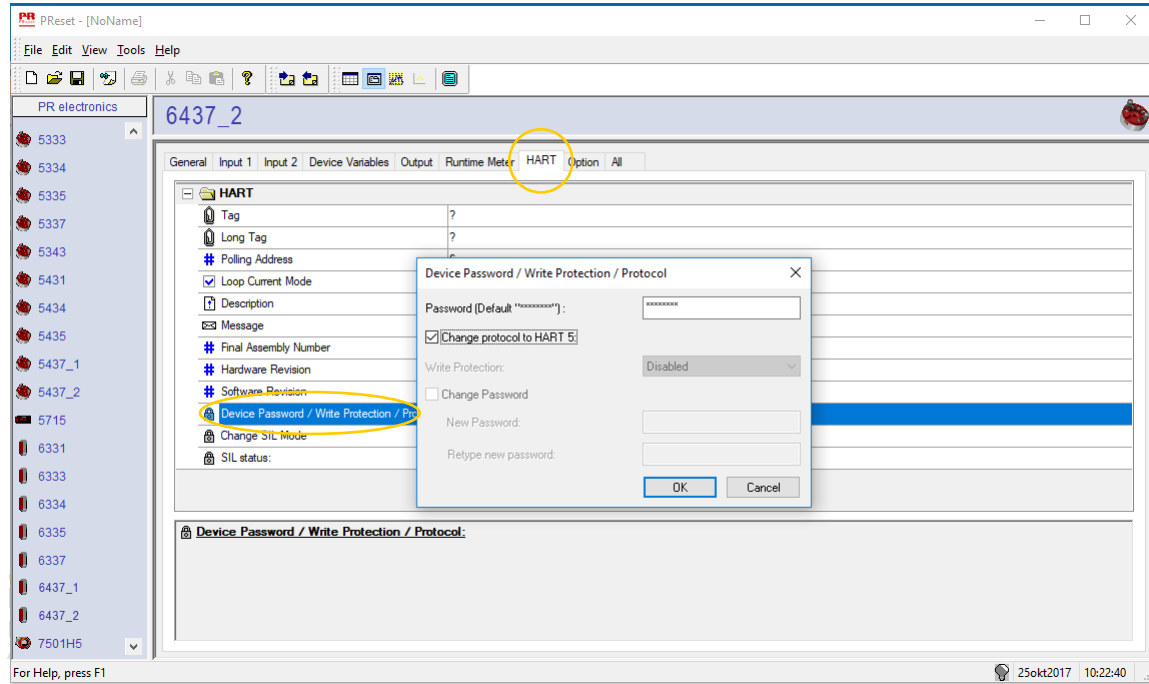

The following message will now appear:

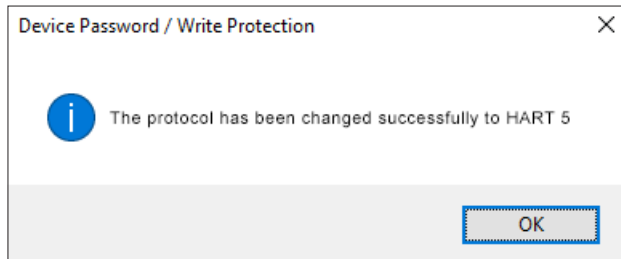

NOTE! After changing to HART 5, the configuration will be reset to the factory default.

Switching from HART 5 to HART 7

Select the 6437 product and click the "HART" tab.

Click "Device Password / Write Protection / Protocol..." and select "Change protocol to HART 7" in the pop-up window, then acknowledge by pressing OK.

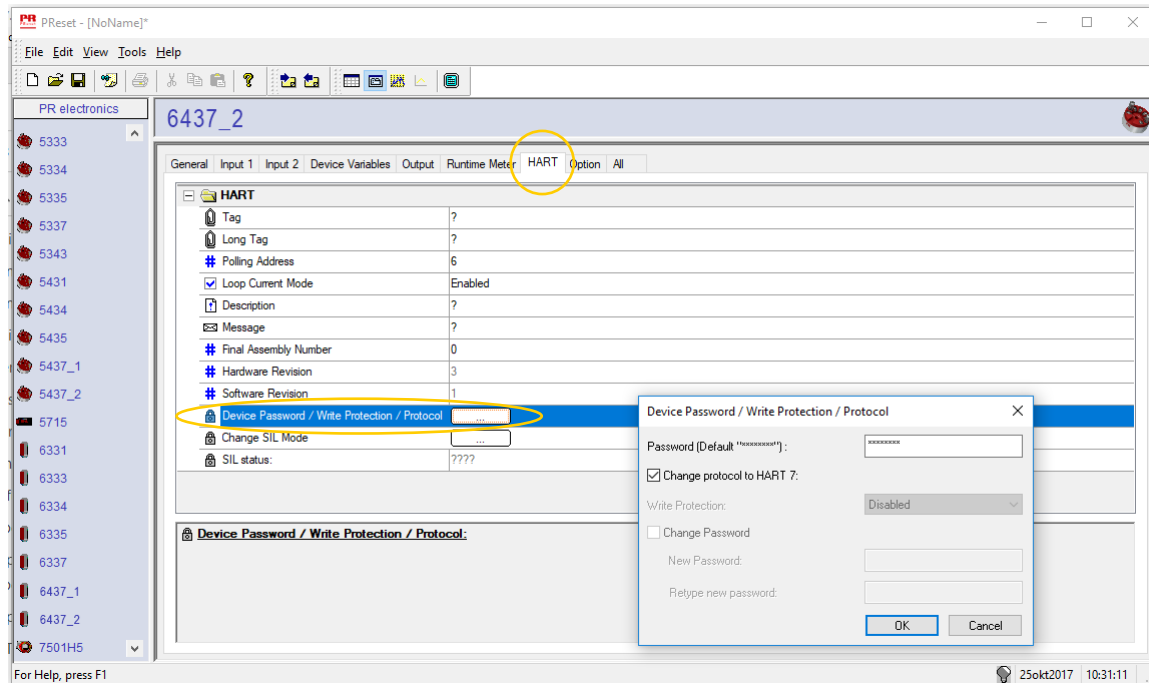

The following message will now appear:

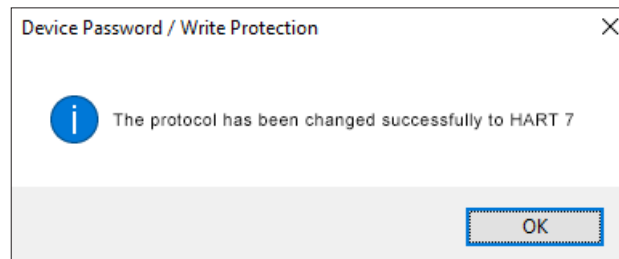

SIL functionality

For instructions and further information on how to enable SIL mode on the 6437 please consult the Safety Manual.

Connections

Single input:

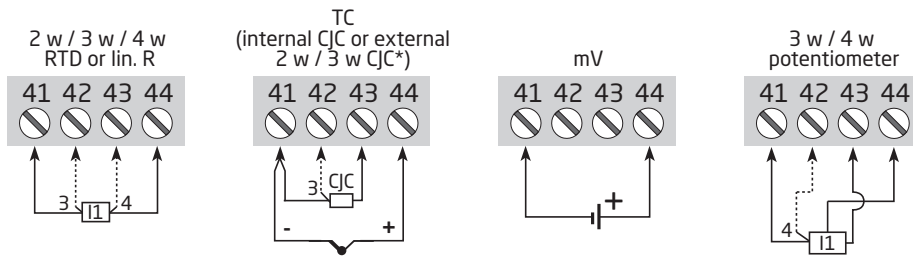

Dual inputs:

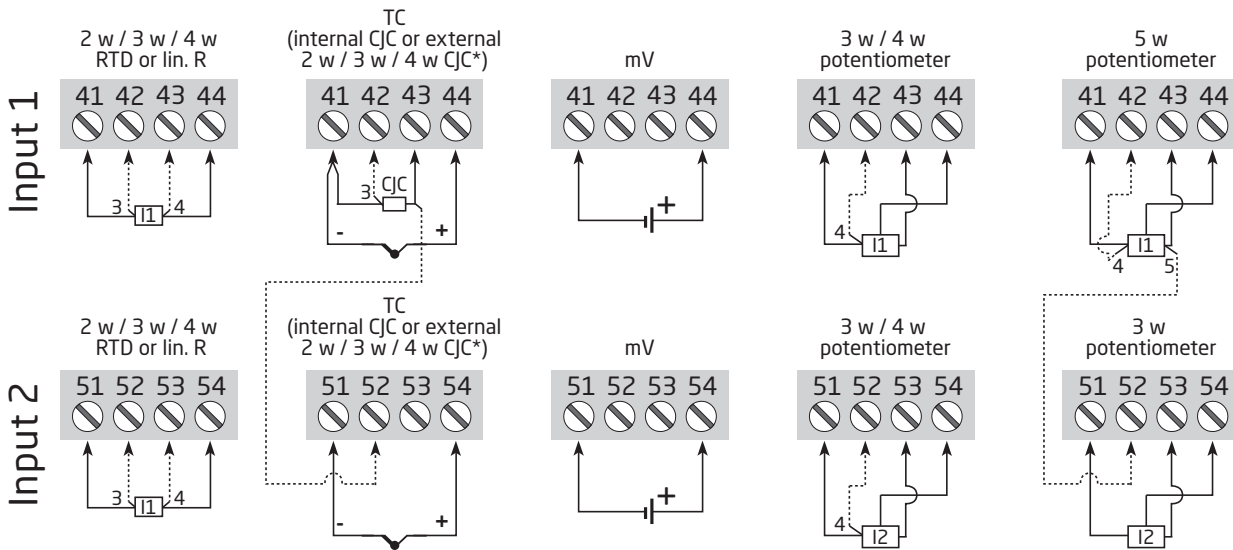

* When using thermocouple input, the 6437 can be configured for either constant, internal or external CJC via a Pt100 or Ni100 sensor. This must be selected during device configuration.

Output:

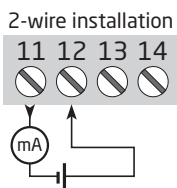

Block diagrams

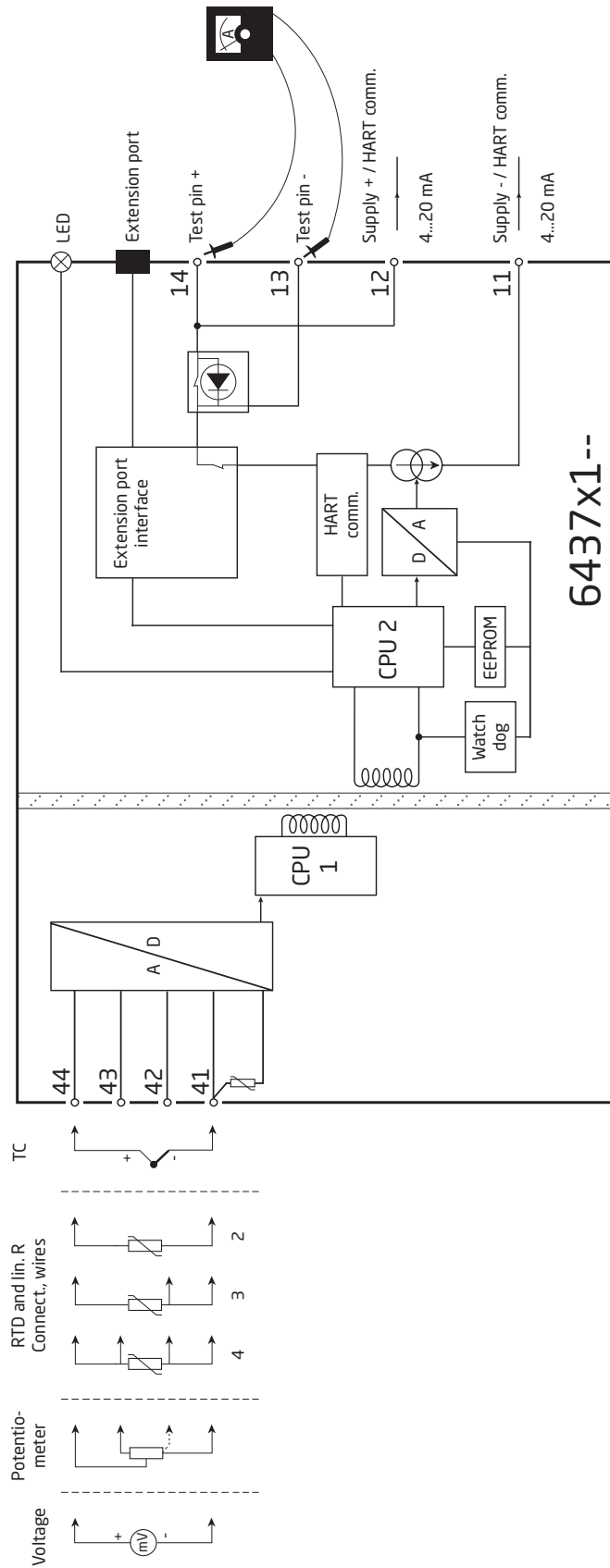

For full overview of input connections, refer to See "Connections" on page 22

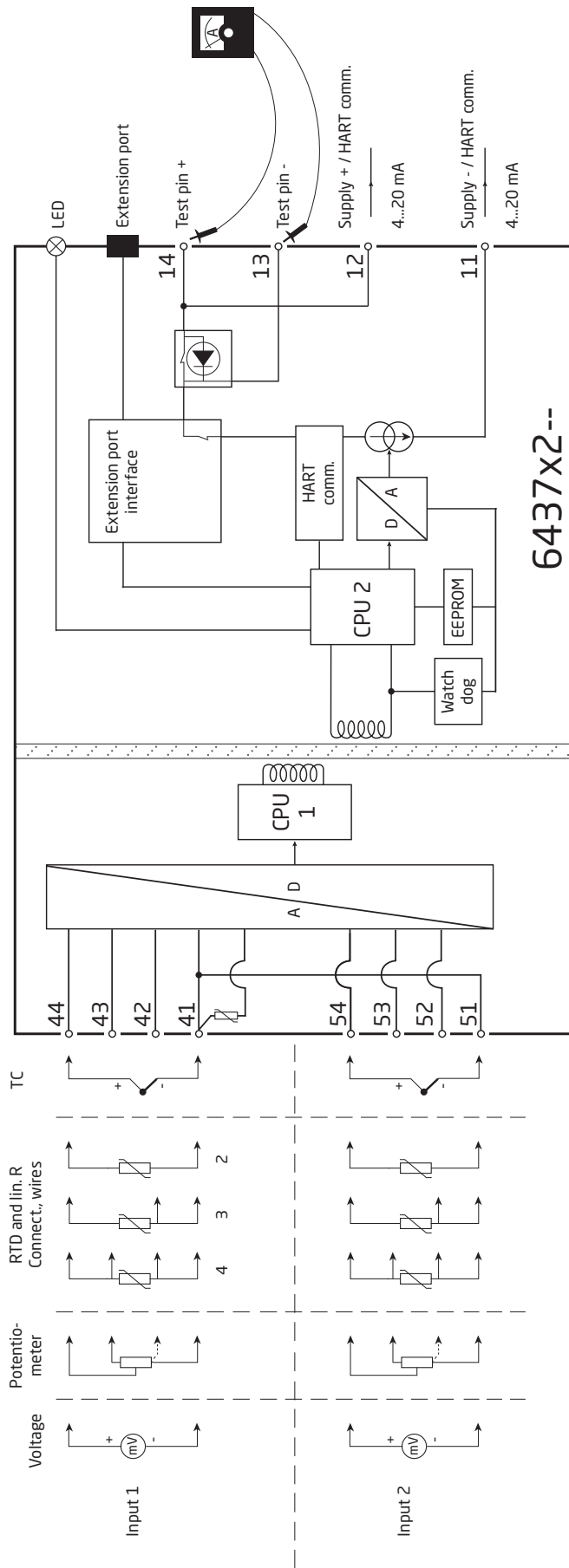

For full overview of input connections, refer to See "Connections" on page 22

Programming

6437 can be configured in the following 4 ways:

1. With PR electronics A/S' communications interface Loop Link and PReset PC configuration software.
2. With a HART modem and PReset PC configuration software.
3. With a HART communicator with PR electronics A/S' DDL driver.
4. Via programming framework, e.g. DCS, PACTWare, etc.

1: Loop Link

For programming please refer to the drawing below and the help functions in PReset.

When communicating with non-installed devices, connectors 11, 12, 13, 14 (channel 1) and 21, 22, 23, 24 (channel 2) can be dismantled in the safe area to connect the terminals of the communications interface to the pins.

Loop Link is not approved for communication with devices installed in hazardous (Ex) area.

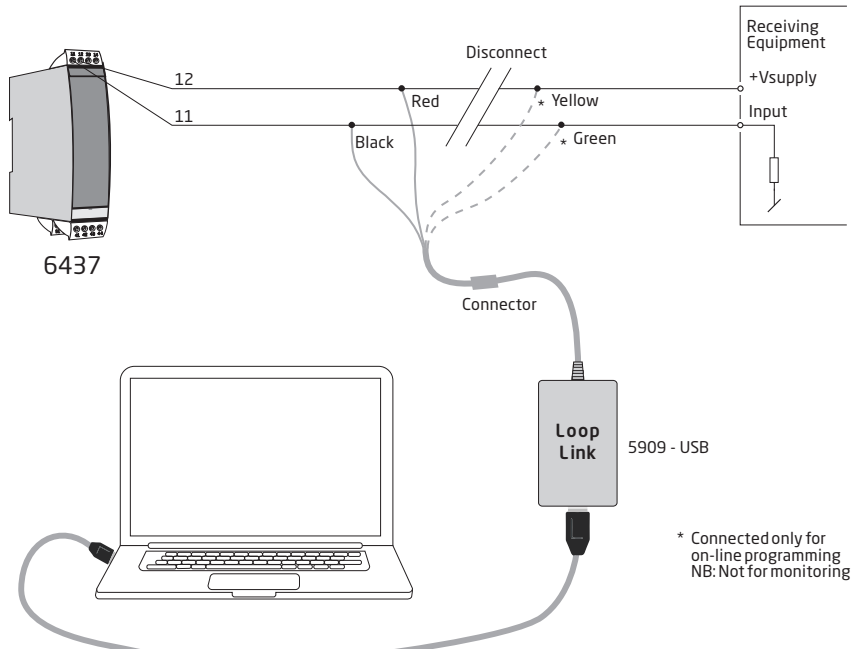

2: HART modem

For programming please refer to the drawing below and the help functions in PReset.

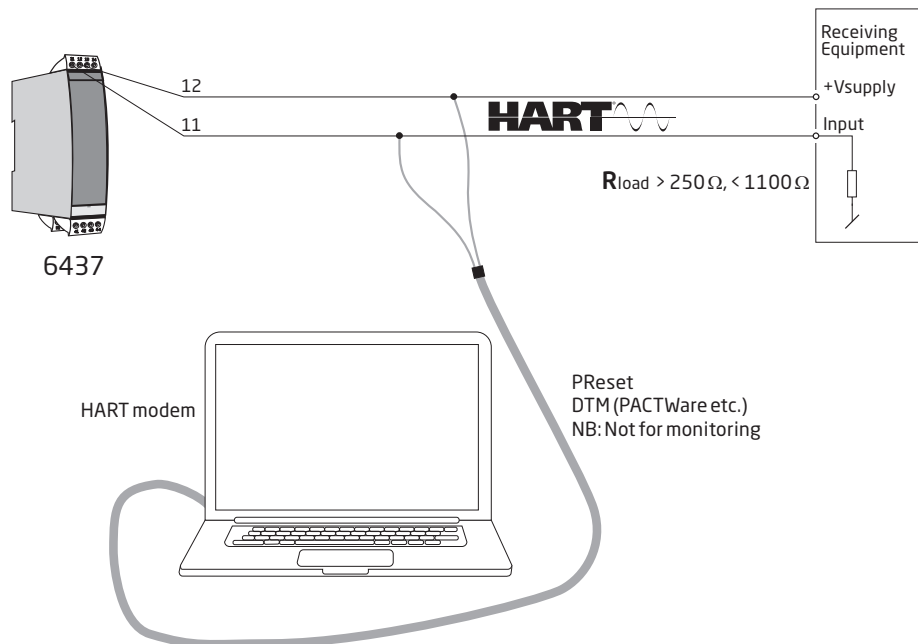

3: HART communicator

For programming please refer to the drawing below. To get access to product-specific commands, the HART communicator must be loaded with the PR electronics A/S DDL driver. This can be ordered either at the HART Communication Foundation or PR electronics A/S.

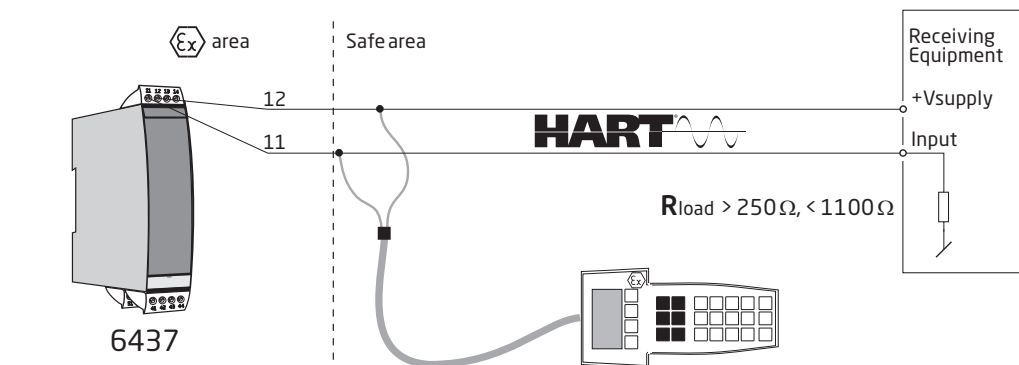

4: Programming framework

Support for both EDD and FDT/DTM technology, offering configuration and monitoring via relevant DCS/Asset Management Systems and supported management packages e.g. Pactware.

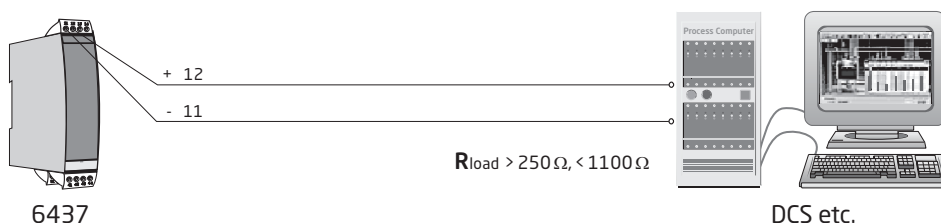

Connection of transmitters in multidrop mode

- The communication is either by means of a HART communicator or a HART modem.
- The HART communicator or a HART modem can be connected across AB or BC.
- The outputs of max. 63 transmitters can be connected in parallel for a digital HART communication on 2-wires.
- Before it is connected, each transmitter must be configured with a unique number from 1 to 63. If 2 transmitters are configured with the same number, both will be excluded. The transmitters must be programmed for multidrop mode (with a fixed output signal of 4 mA). Maximum current in the loop is therefore 252 mA.
- The PReset PC configuration software can configure the individual transmitter for multidrop mode and provide it with a unique polling address.

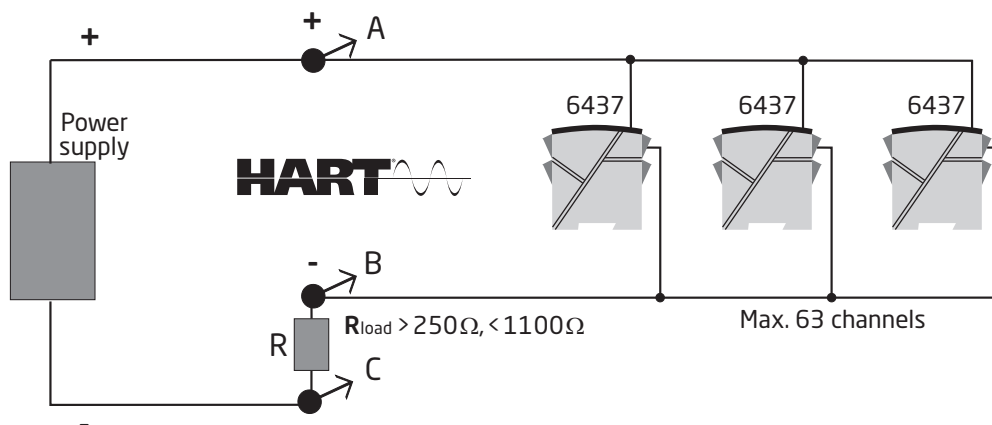

ATEX Installation drawing 6437QA01-V4R0

ATEX Certificate DEKRA 16ATEX 0047X
 Standards: EN 60079-0:2018, EN60079-11:2012

Ex ia Installation

For safe installation of the 6431Dxxx and 6437Dxxx the following must be observed.

Marking



II 1 G Ex ia IIC T6...T4 Ga or
 II 2(1) G Ex ib [ia Ga] IIC T6...T4 Gb
 II 2 D Ex ia IIIC Db
 I M1 Ex ia I Ma

Hazardous Area
 Zone 0, 1, 2, 21, 22 and M1

Unclassified Area

Terminal:
 54,53,52,51 and
 44,43,42,41

Uo: 7.2 VDC
 Io: 7.3 mA
 Po: 13.2 mW
 Lo: 667 mH
 Co: 13.5 µF

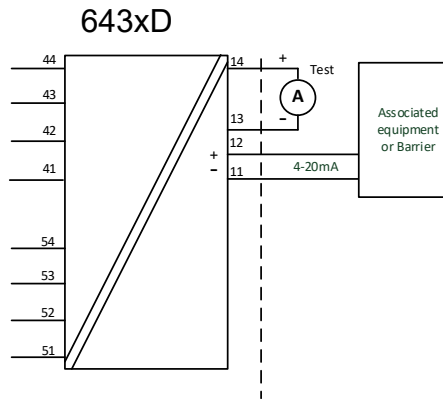

Terminal:
 44,43,42,41

Uo: 7.2 VDC
 Io: 7.3 mA
 Po: 13.2 mW
 Lo: 667 mH
 Co: 13.5 µF

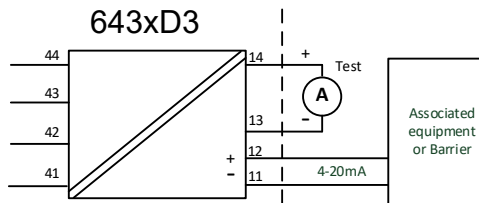

Terminal:
 54,53,52,51

Uo: 7.2 VDC
 Io: 7.3 mA
 Po: 13.2 mW
 Lo: 667 mH
 Co: 13.5 µF

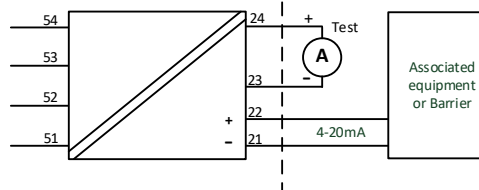

Ex ib Installation

Hazardous Area
Zone 0, 1, 2,
21, 22 and M1

Hazardous Area
Zone 1

Unclassified Area

Terminal:
54,53,52,51 and
44,43,42,41

Uo: 7.2 VDC
Io: 7.3 mA
Po: 13.2 mW
Lo: 667 mH
Co: 13.5 μ F

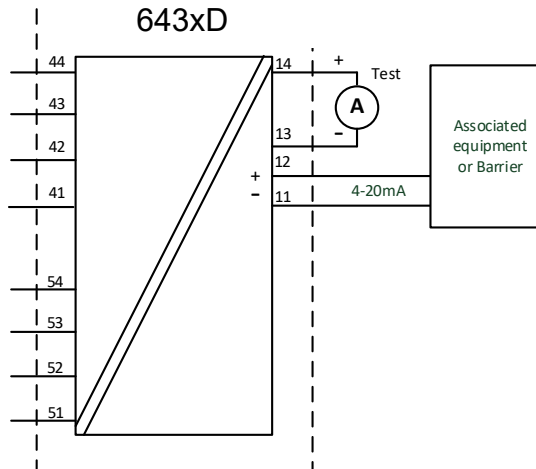

Terminal:
44,43,42,41

Uo: 7.2 VDC
Io: 7.3 mA
Po: 13.2 mW
Lo: 667 mH
Co: 13.5 μ F

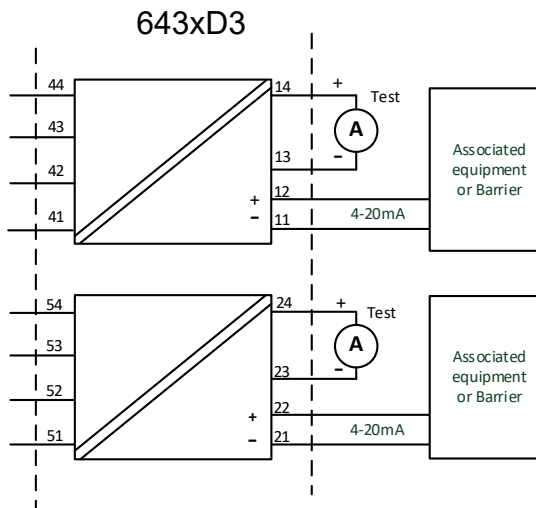

Terminal:
54,53,52,51

Uo: 7.2 VDC
Io: 7.3 mA
Po: 13.2 mW
Lo: 667 mH
Co: 13.5 μ F

643xD1: Terminal: 11,12			
643xD2: Terminal: 11,12			
643xD3: Terminal: Ch1: 11,12 Ch2: 21,22			
Ex ia and ib installation			
Ui: 30 VDC; li: 120 mA; Li: 0 µH; Ci: 1 nF			
P _i per channel	Temperature class	Maximum ambient temperature	
		Single and dual input	Two channel
900 mW	T6	+50°C	+45°C
	T5	+65°C	+60°C
	T4	+85°C	+85°C
750 mW	T6	+55°C	+50°C
	T5	+70°C	+65°C
	T4	+85°C	+85°C
610 mW	T6	+60°C	+55°C
	T5	+75°C	+70°C
	T4	+85°C	+85°C

General installation instructions

Year of manufacture can be taken from the first two digits in the serial number.

If the enclosure is made of non-metallic plastic materials, electrostatic charges on the transmitter enclosure shall be avoided.

The distance between terminals, inclusive the wire's bare part, shall be at least 3 mm separated from any earthed metal.

The test pins allow measurement of loop current directly while maintaining loop integrity. Power must be connected to the transmitter when using the test pins. For hazardous area installation, only certified test equipment may be used.

If the transmitter was applied in type of protection Ex nA or Ex ec, it may afterwards not be applied for intrinsic safety.

The front connector and front test pads provide an intrinsically safe extension-port signal and may only be connected to dedicated equipment of PR electronics.

Warning: Do not connect or disconnect plugs and sockets when energized.

For installation in a potentially explosive dust atmosphere, the following instructions apply:

The transmitter shall be mounted in an enclosure, that is providing a degree of protection of at least IP5X according to EN60529. The enclosure shall be suitable for the application and correctly installed.

Cable entry devices and blanking elements shall fulfill the same requirements.

For EPL Db, the surface temperature of the outer enclosure is +20 K above the ambient temperature, determined without a dust layer.

For installation in mines the following instructions apply:

The transmitter shall be mounted in a metal enclosure that is providing a degree of protection of at least IP54 according to EN60529.

Aluminum enclosures are not allowed for mines.

The enclosure shall be suitable for the application and correctly installed.

Cable entry devices and blanking elements shall fulfill the same requirements.

Ex nA / Ex ec / Ex ic Installation

For safe installation of the 6431Axxx and 6437Axxx the following must be observed.

ATEX Certificate Standards: DEKRA 18ATEX0135X
 EN 60079-0 : 2018, EN 60079-11 : 2012
 EN 60079-7 : 2015+A1:2018, EN 60079-15 : 2010

Marking II 3 G Ex nA IIC T6...T4 Gc
 II 3 G Ex ec IIC T6...T4 Gc
 II 3 G Ex ic IIC T6...T4 Gc
 II 3 D Ex ic IIIC Dc

Hazardous Area
 Zone 2 and 22

Unclassified Area

Terminal:

54,53,52,51 and
 44,43,42,41

Uo: 7.2 VDC
 Io: 7.3 mA
 Po: 13.2 mW
 Lo: 667 mH
 Co: 13.5 µF

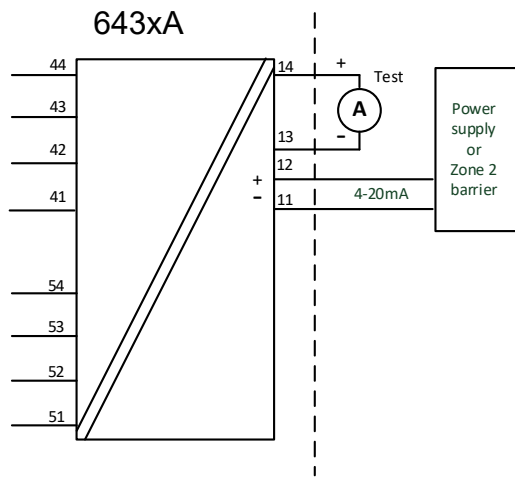

Terminal:

44,43,42,41

Uo: 7.2 VDC
 Io: 7.3 mA
 Po: 13.2 mW
 Lo: 667 mH
 Co: 13.5 µF

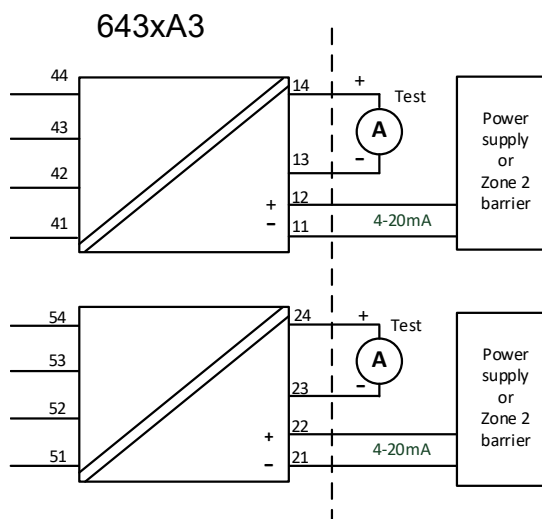

Terminal:

54,53,52,51

Uo: 7.2 VDC
 Io: 7.3 mA
 Po: 13.2 mW
 Lo: 667 mH
 Co: 13.5 µF

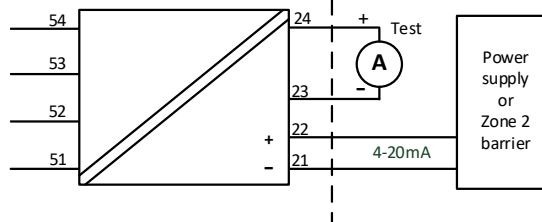

643xA1: Terminal 44 43,42,41	
643xA2: Terminal In1: 44 43,42,41	In2: 54 53,52,51
643xA3 : Terminal Ch1: 44 43,42,41	Ch2: 54 53,52,51
Ex nA & Ex ec	Ex ic
Vmax = 7.2 VDC	Uo: 7.2 VDC; Io: 7.3 mA Po: 13.2 mW; Lo: 667 mH; Co: 13.5 µF

643xA1: Terminal: 11,12					
643xA2: Terminal: 11,12					
643xA3: Terminal: Ch1: 11,12 Ch2: 21,22					
Supply / output circuit				Maximum ambient temperature	
Ex nA & Ex ec	Ex ic Li = 0 uH Ci = 1 nF	Ex ic Ui= 48 VDC, Li = 0 uH, Ci = 1 nF	Temperature class	Single and dual input	Two channel
Vmax= 37 VDC	Ui= 37 VDC	Pi= 851 mW per channel	T4	+85°C	+85°C
			T5	+70°C	+65°C
			T6	+55°C	+50°C
Vmax= 30 VDC	Ui= 30 VDC	Pi= 700 mW per channel	T4	+85°C	+85°C
			T5	+75°C	+70°C
			T6	+60°C	+55°C

General installation instructions

If the enclosure is made of non-metallic plastic materials, electrostatic charges on the transmitter enclosure shall be avoided.

For an ambient temperature $\geq 60^{\circ}\text{C}$, heat resistant cables shall be used with a rating of at least 20 K above the ambient temperature.

The enclosure shall be suitable for the application and correctly installed.

The distance between terminals, inclusive the wire's bare part, shall be at least 3 mm separated from any earthed metal

'TEST' connection, may only be applied when the area is safe, or if supply / output circuit and the applied current meter are intrinsically safe.

Warning: Do not connect or disconnect Terminal Blocks when energized.

For installation in a potentially explosive gas atmosphere, the following instructions apply:

The transmitter must be installed in an enclosure providing a degree of protection of at least IP54 in accordance with EN60079-0. In addition, the enclosure shall provide an internal pollution degree 2 or better as defined in EN 60664-1.

Cable entry devices and blanking elements shall fulfill the same requirements.

For installation in a potentially explosive dust atmosphere, the following instructions apply:

For EPL Dc, the surface temperature of the outer enclosure is +20 K above the ambient temperature, determined without a dust layer.

If the transmitter is supplied with an intrinsically safe signal "ic" and interfaces an intrinsically safe signal "ic" (e.g. a passive device), the transmitter shall be mounted in an enclosure that provides a degree of protection of at least IP54 according to EN60079-0.

Cable entry devices and blanking elements shall fulfill the same requirements.

If the transmitter is installed in an explosive atmosphere requiring the use of equipment protection level Gc and applied in type of protection Ex nA or Ex ec, the transmitter shall be mounted in enclosure that provides a degree of protection of at least IP54 according to IEC 60079-0, and that is suitable for the application and correctly installed. Cable entry devices and blanking elements shall fulfill the same requirements.

IECEX Installation drawing 6437QI01-V4R0

IECEX Certificate IECEX DEK 16.0029X
 Standards: IEC 60079-0:2017, IEC60079-11:2011,
 IEC 60079-15:2010, IEC60079-7: 2017

Ex ia Installation

For safe installation of the 6431Dxxx and 6437Dxxx the following must be observed.

Marking Ex ia IIC T6...T4 Ga or
 Ex ib [ia Ga] IIC T6...T4 Gb
 Ex ia IIIC Db
 Ex ia I Ma

Hazardous Area
 Zone 0, 1, 2, 21, 22 and M1

Unclassified Area

Terminal:
 54,53,52,51 and
 44,43,42,41

Uo: 7.2 VDC
 Io: 7.3 mA
 Po: 13.2 mW
 Lo: 667 mH
 Co: 13.5µF

643xD

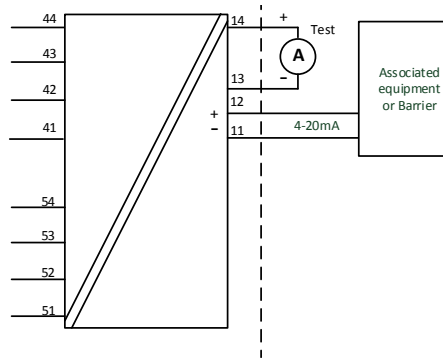

Terminal:
 44,43,42,41

Uo: 7.2 VDC
 Io: 7.3 mA
 Po: 13.2 mW
 Lo: 667 mH
 Co: 13.5µF

643xD3

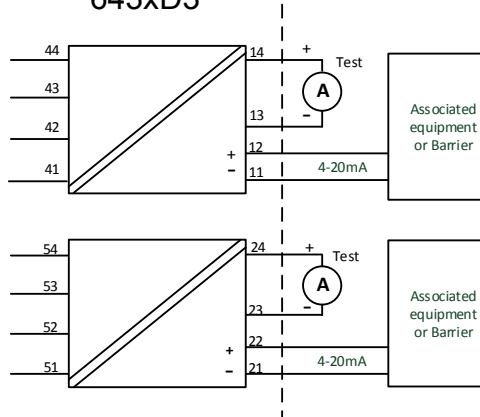

Terminal:
 54,53,52,51

Uo: 7.2 VDC
 Io: 7.3 mA
 Po: 13.2 mW
 Lo: 667 mH
 Co: 13.5µF

Ex ib Installation

Hazardous Area
Zone 0, 1, 2,
21, 22 and M1

Hazardous Area
Zone 1

Unclassified Area

Terminal:

54,53,52,51 and
44,43,42,41

Uo: 7.2 VDC
Io: 7.3 mA
Po: 13.2 mW
Lo: 667 mH
Co: 13.5µF

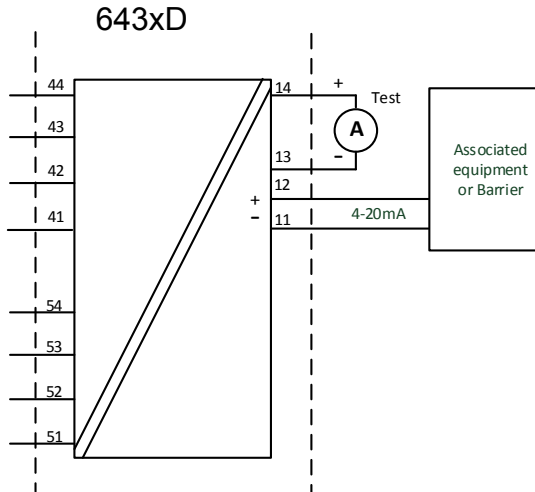

Terminal:

44,43,42,41

Uo: 7.2 VDC
Io: 7.3 mA
Po: 13.2 mW
Lo: 667 mH
Co: 13.5µF

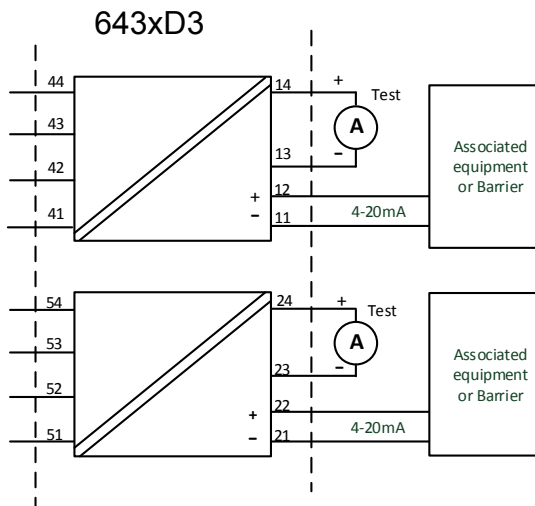

Terminal:

54,53,52,51

Uo: 7.2 VDC
Io: 7.3 mA
Po: 13.2 mW
Lo: 667 mH
Co: 13.5µF

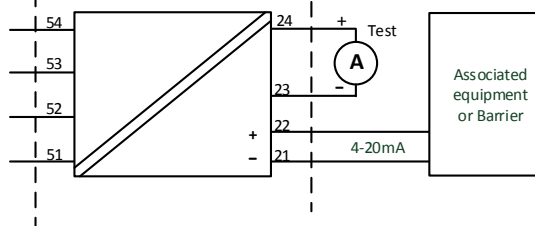

643xD1: Terminal: 11,12			
643xD2: Terminal: 11,12			
643xD3: Terminal: Ch1: 11,12 Ch2: 21,22			
Ex ia and ib installation			
Ui: 30 VDC; li: 120 mA; Li: 0 µH; Ci: 1 nF			
P _i per channel	Temperature class	Maximum ambient temperature	
		Single and dual input	Two channel
900 mW	T6	+50 °C	+45 °C
	T5	+65 °C	+60 °C
	T4	+85 °C	+85 °C
750 mW	T6	+55 °C	+50 °C
	T5	+70 °C	+65 °C
	T4	+85 °C	+85 °C
610 mW	T6	+60 °C	+55 °C
	T5	+75 °C	+70 °C
	T4	+85 °C	+85 °C

General installation instructions

If the enclosure is made of non-metallic plastic materials, electrostatic charges on the transmitter enclosure shall be avoided.

For EPL Ga, if the enclosure is made of aluminum, it must be installed such, that ignition sources due to impact and friction sparks are excluded.

The distance between terminals, inclusive the wire's bare part, shall be at least 3 mm separated from any earthed metal.

The test pins allow measurement of loop current directly while maintaining loop integrity. Power must be connected to the transmitter when using the test pins. For hazardous area installation, only certified test equipment may be used.

If the transmitter was applied in type of protection Ex nA or Ex ec, it may afterwards not be applied for intrinsic safety.

The front connector and front test pads provides an intrinsically safe extension-port signal and may only be connected to dedicated equipment of PR electronics.

Warning: Do not connect or disconnect plugs and sockets when energized.

For installation in a potentially explosive dust atmosphere, the following instructions apply:

If the transmitter is installed in an explosive atmosphere requiring the use of equipment protection level Db or Dc and applied in type of protection Ex ia or Ex ic, the transmitter shall be mounted in enclosure that provides a degree of protection of at least IP5X according to IEC 60079-0, and that is suitable for the application and correctly installed.

Cable entry devices and blanking elements shall fulfill the same requirements.

The surface temperature of the outer enclosure is +20 K above the ambient temperature, determined without a dust layer.

For installation in mines the following instructions apply:

The transmitter shall be mounted in a metal enclosure that is providing a degree of protection of at least IP54 according to IEC60529.

Aluminum enclosures are not allowed for mines.
 The enclosure shall be suitable for the application and correctly installed.
 Cable entry devices and blanking elements shall fulfill the same requirements.

Ex nA / Ex ec / Ex ic Installation

For safe installation of the 6431Axxx and 6437Axxx the following must be observed.

Marking
 Ex nA IIC T6...T4 Gc
 Ex ec IIC T6...T4 Gc
 Ex ic IIC T6...T4 Gc
 Ex ic IIIC Dc

Hazardous Area
 Zone 2 and 22

Unclassified Area

Terminal:
 54,53,52,51 and
 44,43,42,41

Uo: 7.2 VDC
 Io: 7.3 mA
 Po: 13.2 mW
 Lo: 667 mH
 Co: 13.5µF

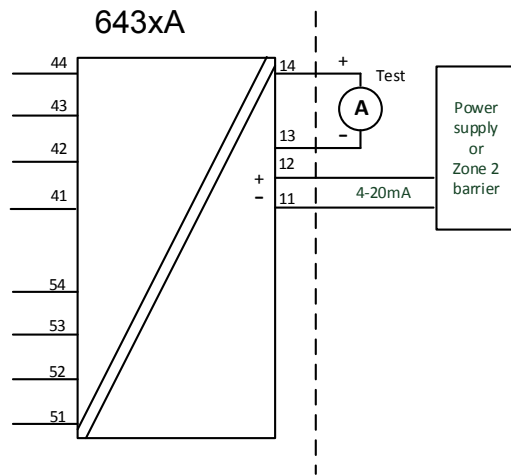

Terminal:
 44,43,42,41

Uo: 7.2 VDC
 Io: 7.3 mA
 Po: 13.2 mW
 Lo: 667 mH
 Co: 13.5µF

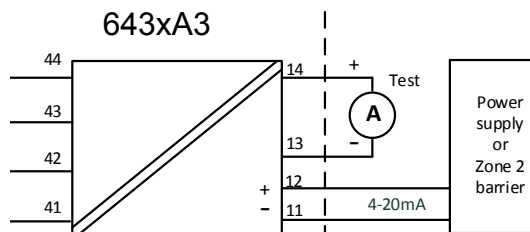

Terminal:
 54,53,52,51

Uo: 7.2 VDC
 Io: 7.3 mA
 Po: 13.2 mW
 Lo: 667 mH
 Co: 13.5µF

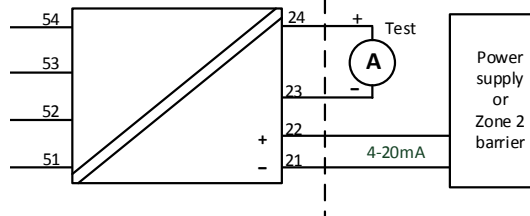

643xA1: Terminal 44 43,42,41	
643xA2: Terminal In1: 44 43,42,41 In2: 54 53,52,51	
643xA3 : Terminal Ch1: 44 43,42,41 Ch2: 54 53,52,51	
Ex nA & Ex ec	Ex ic
Vmax = 7.2VDC	Uo: 7.2 VDC; Io: 7.3 mA Po: 13.2 mW; Lo: 667 mH; Co: 13.5µF

643xA1: Terminal: 11,12					
643xA2: Terminal: 11,12					
643xA3: Terminal: Ch1: 11,12 Ch2: 21,22					
Supply / output circuit				Maximum ambient temperature	
Ex nA & Ex ec	Ex ic Li = 0 uH Ci = 1 nF	Ex ic Ui= 48 VDC, Li = 0 uH, Ci = 1 nF	Temperature class	Single and dual input	Two channel
Vmax= 37 VDC	Ui= 37 VDC	Pi= 851 mW per channel	T4	+85 °C	+85 °C
			T5	+70 °C	+65 °C
			T6	+55 °C	+50 °C
Vmax= 30 VDC	Ui= 30 VDC	Pi= 700 mW per channel	T4	+85 °C	+85 °C
			T5	+75 °C	+70 °C
			T6	+60 °C	+55 °C

General installation instructions

If the enclosure is made of non-metallic plastic materials, electrostatic charges on the transmitter enclosure shall be avoided.

For an ambient temperature $\geq 60^{\circ}\text{C}$, heat resistant cables shall be used with a rating of at least 20 K above the ambient temperature.

The enclosure shall be suitable for the application and correctly installed

The distance between terminals, inclusive the wires bare part, shall be at least 3 mm separated from any earthed metal

'TEST' connection, may only be applied when the area is safe, or if supply / output circuit and the applied current meter are intrinsically safe.

Warning: Do not connect or disconnect Terminal Blocks when energized.

For installation in a potentially explosive gas atmosphere, the following instructions apply:

The transmitter shall be installed in an enclosure providing a degree of protection of not less than IP54 in accordance with IEC 60079-0, which is suitable for the application and correctly installed e.g. in an enclosure that is in type of protection Ex n or Ex e. Additionally, the area inside the enclosure shall be pollution degree 2 or better as defined in IEC 60664-1.

Cable entry devices and blanking elements shall fulfill the same requirements.

For installation in a potentially explosive dust atmosphere, the following instructions apply:

For EPL Dc, the surface temperature of the outer enclosure is +20 K above the ambient temperature, determined without a dust layer.

If the transmitter is supplied with an intrinsically safe signal "ic" and interfaces an intrinsically safe signal "ic" (e.g. a passive device), the transmitter shall be mounted in an enclosure that provides a degree of protection of at least IP54 according to IEC 60079-0. Cable entry devices and blanking elements shall fulfill the same requirements.

If the transmitter is installed in an explosive atmosphere requiring the use of equipment protection level Gc and applied in type of protection Ex nA or Ex ec, the transmitter shall be mounted in enclosure that provides a degree of protection of at least IP54 according to IEC 60079-0, and that is suitable for the application and correctly installed. Cable entry devices and blanking elements shall fulfill the same requirements.

CSA Installation drawing 6437QC01-V3R0

CSA Certificate 16.70066266

Division1 / Ex ia, Intrinsic Safe Installation

For safe installation of the 6431Dxxx and 6437Dxxx the following must be Observed.

Marking: Class I Division 1, Groups A,B,C,D
 Ex ia IIC T6...T4
 Class I, Zone 0: AEx ia IIC, T6...T4
 Ex ib [ia] IIC T6...T4
 Class I, Zone 1: AEx ib [ia] IIC T6...T4

IS Installation instructions

- Install in accordance with the US the National Electrical Code (NEC) or for Canada the Canadian Electrical Code (CEC).
- The transmitter must be installed in a suitable enclosure to meet installation codes stipulated in the Canadian Electrical Code (CEC) or for US the National Electrical Code (NEC).
- To establish Class II and Class III, Division 1 or IIIC ratings, the equipment shall be installed in an enclosure that is approved for use in Class II and Class III hazardous (classified) locations.
- If the enclosure is made of non-metallic materials or of painted metal, electrostatic charging shall be avoided.
- Use supply wires with a rating of at least 5 K above the ambient temperature.

WARNING: Substitution of components may impair intrinsic safety

AVERTISSEMENT: la substitution de composants peut nuire à la sécurité intrinsèque

Hazardous Area
 CL I, DIV 1 or
 CL I, Zone 0

Non Classified Area

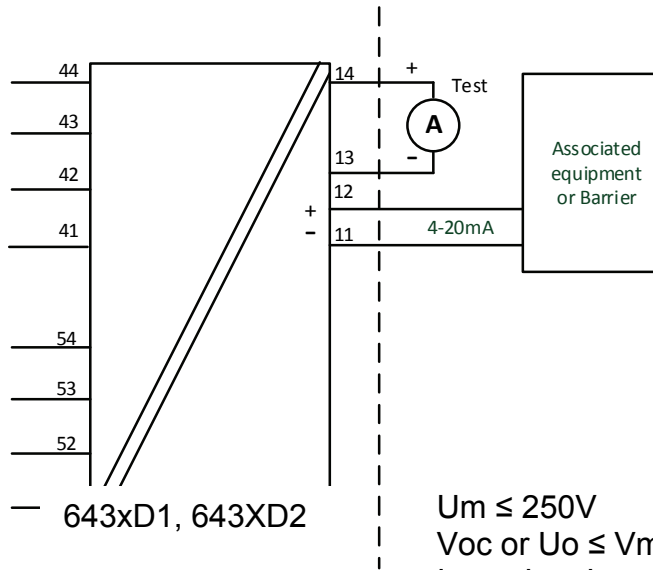

$U_m \leq 250V$
 $V_{oc} \text{ or } U_o \leq V_{max} \text{ or } U_i$
 $I_{sc} \text{ or } I_o \leq I_{max} \text{ or } I_i$
 $P_o \leq P_{max} \text{ or } P_i$
 $C_a \text{ or } C_o \geq C_i + C_{cable}$
 $L_a \text{ or } L_o \geq L_i + L_{cable}$

	Terminal 44,43,42,41 and 54,53,52,51	Terminal 44,43,42,41,54,53,52,51
U _o	7.2 VDC	7.2 VDC
I _o	7.3 mA	12.9 mA
P _o	13.2 mW	23.3 mW
L _o	667 mH	200 mH
C _o	13.5 μF	13.5 μF

Terminal 11,12 Ex ia / Div 1;	Temperature Range
U _i : 30 VDC; I _i : 120 mA ; P _i :900 mW; L _i :0 μH; C _i :1.0nF	T4: -50 ≤ T _a ≤ 85°C T5: -50 ≤ T _a ≤ 70°C T6: -50 ≤ T _a ≤ 55°C
U _i : 30 VDC; I _i : 100 mA ; P _i :750 mW; L _i :0 μH; C _i :1.0nF	T4: -50 ≤ T _a ≤ 85°C T5: -50 ≤ T _a ≤ 75°C T6: -50 ≤ T _a ≤ 60°C

Hazardous Area
CL I, DIV 1 or
CL I, Zone 0

Non Classified Area

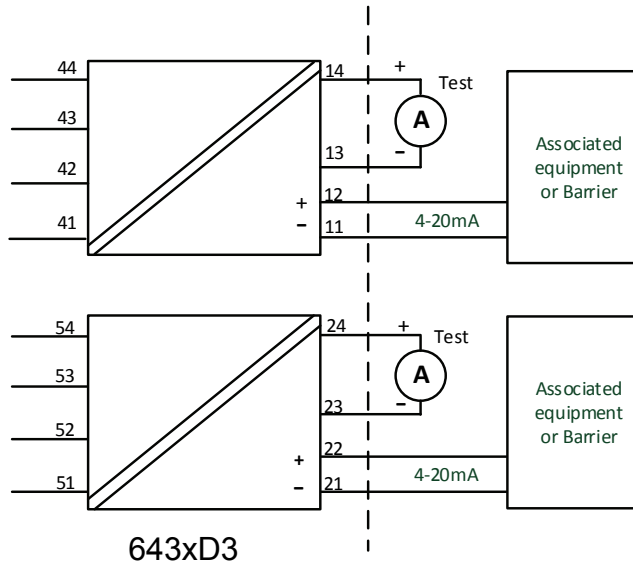

643xD3

$U_m \leq 250V$
 $V_{oc} \text{ or } U_o \leq V_{max} \text{ or } U_i$
 $I_{sc} \text{ or } I_o \leq I_{max} \text{ or } I_i$
 $P_o \leq P_{max} \text{ or } P_i$
 $C_a \text{ or } C_o \geq C_i + C_{cable}$
 $L_a \text{ or } L_o \geq L_i + L_{cable}$

	Terminal 44,43,42,41 and 54,53,52,51
U _o	7.2 VDC
I _o	7.3 mA
P _o	13.2 mW
L _o	667 mH
C _o	13.5 μF

Terminal 11,12 and 21 22 Ex ia / Div 1	Temperature Range
P _i : 900 mW U _i : 30 VDC; I _i : 120 mA L _i : 0 μH; C _i : 1.0nF	T4: -50 ≤ T _a ≤ 85°C T5: -50 ≤ T _a ≤ 70°C T6: -50 ≤ T _a ≤ 55°C
P _i : 750 mW U _i : 30 VDC; I _i : 100 mA L _i : 0 μH; C _i : 1.0nF	T4: -50 ≤ T _a ≤ 85°C T5: -50 ≤ T _a ≤ 75°C T6: -50 ≤ T _a ≤ 60°C

Zone 0 / Zone 1, Intrinsic Safe Installation

Hazardous Area
CL I, Zone 0 IIC

Hazardous Area
CL I, Zone 1 IIC

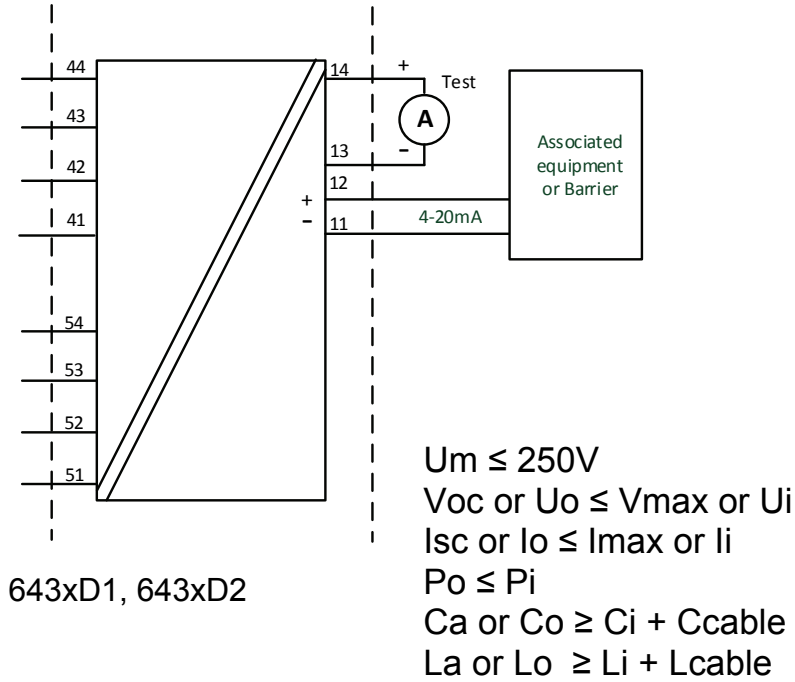

	Terminal 44,43,42,41 and 54,53,52,51	Terminal 44,43,42,41,54,53,52,51
Uo	7.2 VDC	7.2 VDC
Io:	7.3 mA	12.9 mA
Po	13.2 mW	23.3 mW
Lo:	667 mH	200 mH
Co	13.5 μ F	13.5 μ F

Terminal 11,12 Ex ib [ia Ga] IIC T6...T4 Gb;	Temperature Range
Pi:900 mW; Ui: 30 VDC; Ii: 120 mA ; Li:0 μ H; Ci:1.0nF	T4: $-50 \leq T_a \leq 85^\circ C$ T5: $-50 \leq T_a \leq 70^\circ C$ T6: $-50 \leq T_a \leq 55^\circ C$
Pi:750 mW; Ui: 30 VDC; Ii: 100 mA ; Li:0 μ H; Ci:1.0nF	T4: $-50 \leq T_a \leq 85^\circ C$ T5: $-50 \leq T_a \leq 75^\circ C$ T6: $-50 \leq T_a \leq 60^\circ C$

Hazardous Area
CL I, Zone 0 IIC

Hazardous Area
CL I, Zone 1 IIC

Non Classified Area

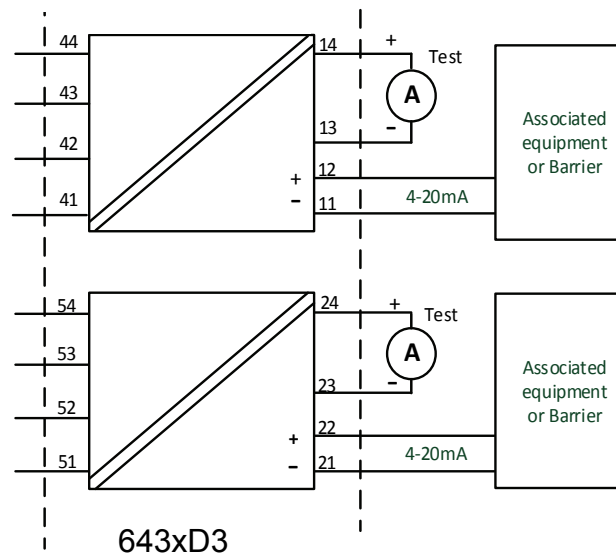

$U_m \leq 250V$
 $V_{oc} \text{ or } U_o \leq V_{max} \text{ or } U_i$
 $I_{sc} \text{ or } I_o \leq I_{max} \text{ or } I_i$
 $P_o \leq P_i$
 $C_a \text{ or } C_o \geq C_i + C_{cable}$
 $L_a \text{ or } L_o \geq L_i + L_{cable}$

	Terminal 44,43,42,41 and 54,53,52,51
U _o	7.2 VDC
I _o	7.3 mA
P _o	13.2 mW
L _o	667 mH
C _o	13.5 μF

Terminal 11,12 and 21 22 Ex ib [ia Ga] IIC T6...T4 Gb	Temperature Range
P _i : 900 mW U _i : 30 VDC; I _i : 120 mA L _i :0 μH; C _i :1.0nF	T4: -50 ≤ T _a ≤ 85°C T5: -50 ≤ T _a ≤ 70°C T6: -50 ≤ T _a ≤ 55°C
P _i : 750 mW U _i : 30 VDC; I _i : 100 mA L _i :0 μH; C _i :1.0nF	T4: -50 ≤ T _a ≤ 85°C T5: -50 ≤ T _a ≤ 75°C T6: -50 ≤ T _a ≤ 60°C

Division 2 / Ex nA, Non Incendive Installation

For safe installation of the 6431Axxx and 6437Axxx the following must be observed.

Marking Class I, Division 2, Groups A, B, C, D
 Ex nA IIC T6...T4
 Class I, Zone 2: AEx nA IIC T6...T4
 Ex nA [ic] IIC T6...T4
 Class I, Zone 2: AEx nA [ic] IIC T6...T4

Hazardous Area

CL I, Div 2, GP ABCD 643xA
 CL I, Zone 2, IIC

Unclassified Area

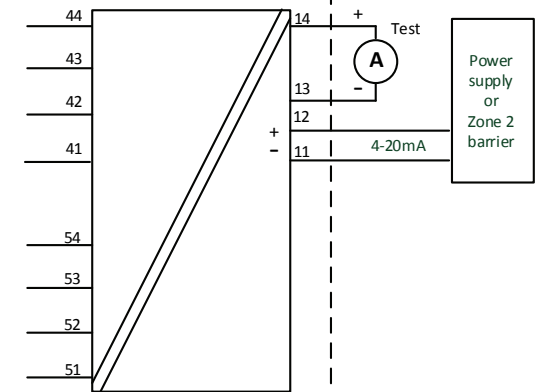

643xA3

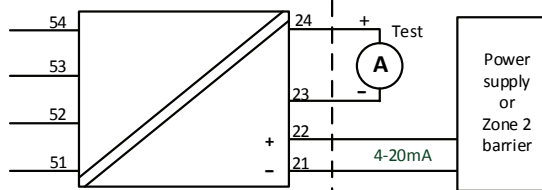
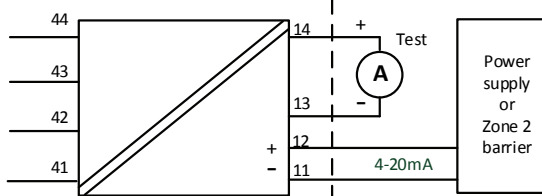

Terminal:

54,53,52,51
 44,43,42,41

Vmax: 7.2 VDC

Terminal 11, 12 and 21, 22 Ex nA	Temperature Range
Supply voltage: max 37 VDC	T4: $-50 \leq T_a \leq 85^{\circ}\text{C}$ T5: $-50 \leq T_a \leq 70^{\circ}\text{C}$ T6: $-50 \leq T_a \leq 55^{\circ}\text{C}$
Supply voltage: max 30 VDC	T4: $-50 \leq T_a \leq 85^{\circ}\text{C}$ T5: $-50 \leq T_a \leq 75^{\circ}\text{C}$ T6: $-50 \leq T_a \leq 60^{\circ}\text{C}$

NI Installation instructions

- The transmitter must be installed in an enclosure providing a degree of protection of at least IP54 according to IEC60529 that is suitable for the application and is correctly installed. Cable entry devices and blanking elements shall fulfill the same requirements.
- If the enclosure is made of non-metallic materials or of painted metal, electrostatic charging shall be avoided.
- Use supply wires with a rating of at least 5 K above the ambient temperature.

WARNING: Substitution of components may impair suitability for Class I, Division 2

AVERTISSEMENT: la substitution de composants peut nuire à l'aptitude à la Classe I, Division 2.

WARNING: Do not disconnect equipment unless power has been switched off or the area is known to be safe.

AVERTISSEMENT: Ne débranchez pas l'équipement sauf si l'alimentation a été coupée ou si la zone est connue pour être sûre.

Non Incendive field wiring installation

The non incendive field Wiring Circuit concept allows interconnection of Nonincendive Field wiring Apparatus with Associated Nonincendive Field Wiring Apparatus or Associated Intrinsically Safe Apparatus or Associated Apparatus not specially examined in combination as a system using any of the wiring methods permitted for unclassified locations, $V_{oc} < V_{max}$, $C_a \geq C_i + C_{cable}$, $L_a \geq L_i + L_{cable}$.

Terminal 11, 12 and 21, 22 Non Incendive Field wiring parameters	Temperature Range
$V_{max} = 30 \text{ VDC}$, $C_i = 1\text{nF}$, $L_i = 0$	T4: $-50 \leq T_a \leq 85^{\circ}\text{C}$ T5: $-50 \leq T_a \leq 75^{\circ}\text{C}$ T6: $-50 \leq T_a \leq 60^{\circ}\text{C}$

Functional Ratings:

$U_{nom} \leq 30 \text{ VDC}$; $I_{nom} \leq 3.5 - 23 \text{ mA}$

FM Installation drawing 6437QF01-V2R0

Division1 / Zone 0, Intrinsic Safe Installation

For safe installation of the 6431Dxxx and 6437Dxxx the following must be observed.

Marking
 CL I, Div 1, Gp A,B,C,D
 CL I, Zone 0 AEx ia IIC, T6...T4
 CL I, Zone 1 [0] AEx ib [ja] IIC, T6...T4
 Ex ia IIC, T6...T4
 Ex ib [ja Ga] IIC, T6...T4 Gb

Hazardous Area

CL I, Div 1, GP ABCD
 CL I, Zone0 IIC

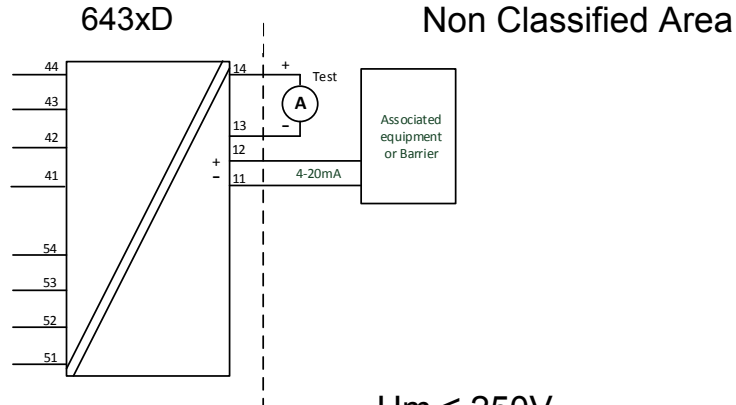

Terminals:

54,53,52,51
 44,43,42,41

U_o: 7.2 VDC
 I_o: 12.9 mA
 P_o: 23.3 mW
 L_o: 200 mH
 C_o: 13.5µF

U_m ≤ 250V
 V_{oc} or U_o ≤ V_{max} or U_i
 I_{sc} or I_o ≤ I_{max} or I_i
 P_o ≤ P_i
 C_a or C_o ≥ C_i + C_{cabl}
 L_a or L_o ≥ L_i + L_{cabl}

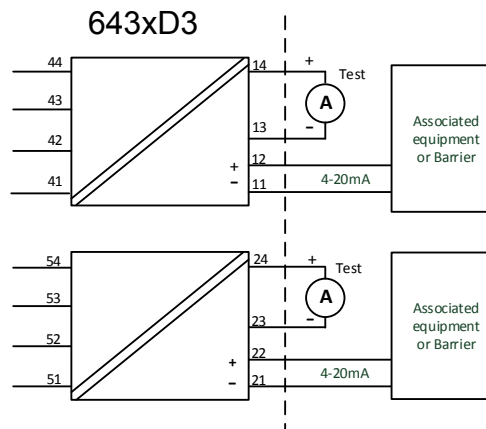

Terminal 11,12 and 21, 22 Ex ia / Div 1	Temperature Range
AEx/Ex ia IIC, T6...T4 Ga CL I, Div 1, Gp ABCD, T6...T4;	
Ui: 30 VDC; li: 120 mA ; Pi:900 mW; Li:0 μH; Ci:1.0nF	T4: $-50 \leq Ta \leq 85^{\circ}\text{C}$ T5: $-50 \leq Ta \leq 70^{\circ}\text{C}$ T6: $-50 \leq Ta \leq 55^{\circ}\text{C}$
Ui: 30 VDC; li: 100 mA ; Pi:750 mW; Li:0 μH; Ci:1.0nF	T4: $-50 \leq Ta \leq 85^{\circ}\text{C}$ T5: $-50 \leq Ta \leq 75^{\circ}\text{C}$ T6: $-50 \leq Ta \leq 60^{\circ}\text{C}$

Zone 0 / Zone 1, Intrinsic Safe Installation

Hazardous Area
CL I, Zone 0 IIC

Hazardous Area
CL I, Zone 1 IIC

Non Classified Area

Terminals:
54,53,52,51
44,43,42,41

Uo: 7.2 VDC
Io: 12.9 mA
Po: 23.3 mW
Lo: 200 mH
Co: 13.5μF

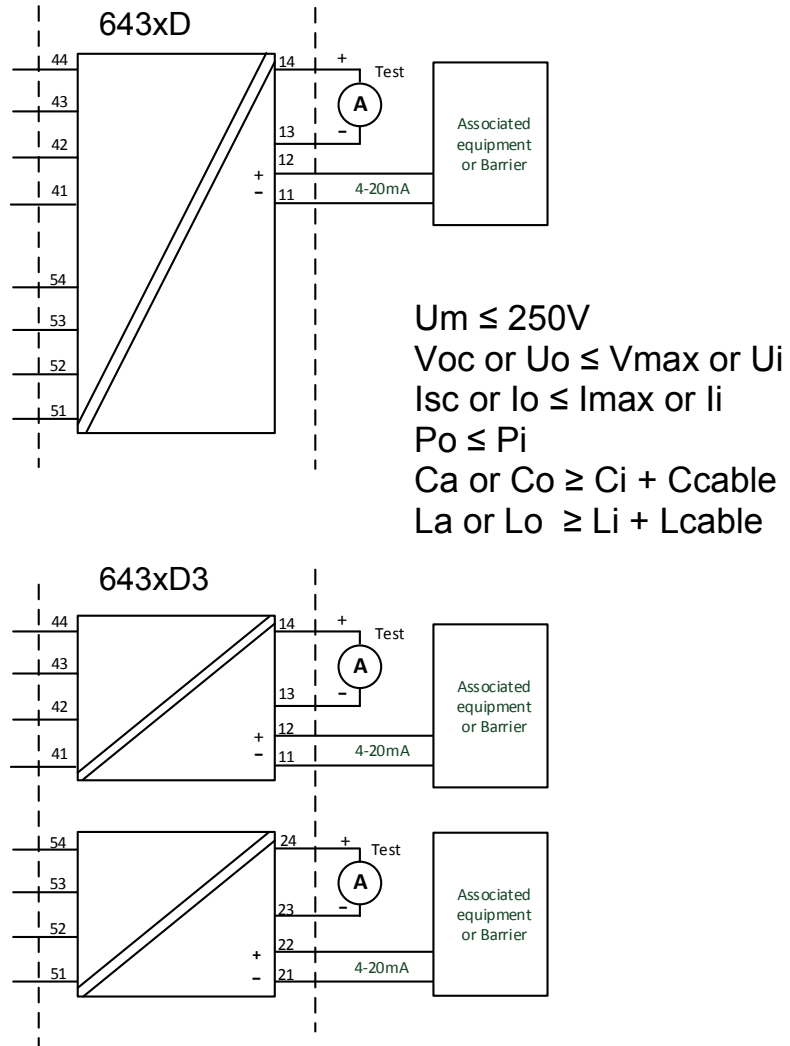

Terminal 11,12 and 21, 22 Ex ib [ia Ga] IIC T6...T4 Gb;	Temperature Range
Ui: 30 VDC; li: 120 mA ; Pi:900 mW; Li:0 µH; Ci:1.0nF	T4: -50 ≤ Ta ≤ 85°C T5: -50 ≤ Ta ≤ 70°C T6: -50 ≤ Ta ≤ 55°C
Ui: 30 VDC; li: 100 mA ; Pi:750 mW; Li:0 µH; Ci:1.0nF	T4: -50 ≤ Ta ≤ 85°C T5: -50 ≤ Ta ≤ 75°C T6: -50 ≤ Ta ≤ 60°C

IS installation instructions

- Install in accordance with the US the National Electrical Code (NEC) or for Canada the Canadian Electrical Code (CEC).
- Equipment that is FM-approved for intrinsic safety may be connected to barriers based on the ENTITY CONCEPT. This concept permits interconnection of approved transmitters, meters and other devices in combinations which have not been specifically examined by FM, provided that the agency's criteria are met. The combination is then intrinsically safe, if the entity concept is acceptable to the authority having jurisdiction over the installation.
- The entity concept criteria are as follows:
The intrinsically safe devices, other than barriers, must not be a source of power. The maximum voltage U_i (V_{max}) and current i_i (I_{max}), and maximum power P_i (P_{max}), which the device can receive and remain intrinsically safe, must be equal to or greater than the voltage (U_o or V_{oc} or V_t) and current (I_o or I_{sc} or I_t) and the power P_o which can be delivered by the barrier.
- The sum of the maximum unprotected capacitance (C_i) for each intrinsically device and the interconnecting wiring must be less than the capacitance (C_a) which can be safely connected to the barrier.
- The sum of the maximum unprotected inductance (L_i) for each intrinsically device and the interconnecting wiring must be less than the inductance (L_a) which can be safely connected to the barrier.
- The entity parameters U_o, V_{oc} or V_t and I_o, I_{sc} or I_t , and C_a and L_a for barriers are provided by the barrier manufacturer.
- The transmitter must be installed in a suitable enclosure to meet installation codes stipulated in the Canadian Electrical Code (CEC) or for US the National Electrical Code (NEC).
- If the enclosure is made of non-metallic materials or of painted metal, electrostatic charging shall be avoided.
- Use supply wires with a rating of at least 5 K above the ambient temperature.

WARNING: Substitution of components may impair intrinsic safety

AVERTISSEMENT: la substitution de composants peut nuire à la sécurité intrinsèque

Division 2 / Zone 2, Non Sparking Installation

For safe installation of the 6431Axxx and 6437Axxx the following must be observed.

Marking Class I, Division 2, GP A,B,C,D; T6...T4
 Class I, Zone 2 AEx nA IIC, T6...T4 Gc
 Class I, Zone 2 Ex nA IIC, T6...T4 Gc
 NIFW, CL I, Div 2, GP A,B,C,D

Hazardous Area
 CL I, Div 2, GP ABCD
 CL I, Zone 2 IIC

Unclassified Area

643xA

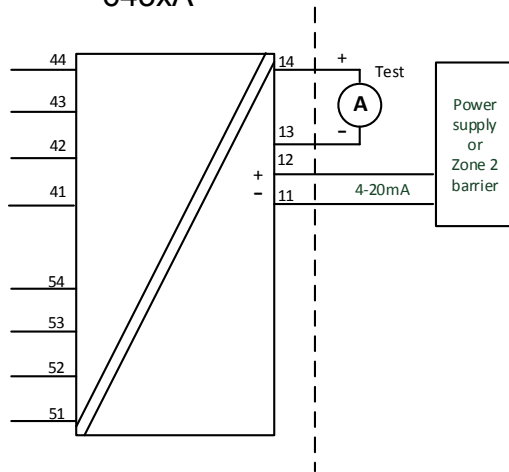

Terminal:
 54,53,52,51
 44,43,42,41

Vmax: 7.2 VDC

643xA3

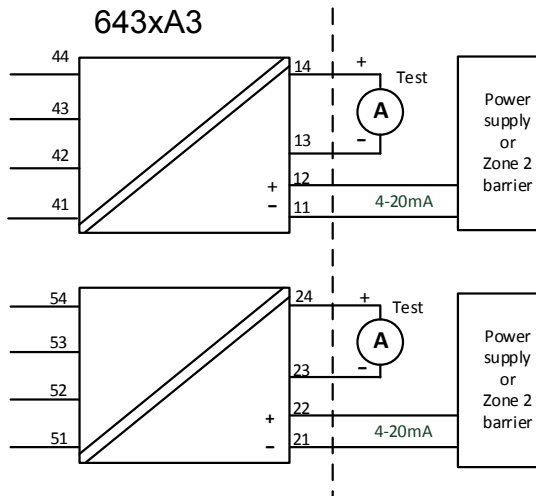

Terminal 11, 12 and 21, 22 Ex nA	Temperature Range
Supply voltage: max 37 VDC	T4: $-50 \leq T_a \leq 85^{\circ}\text{C}$ T5: $-50 \leq T_a \leq 70^{\circ}\text{C}$ T6: $-50 \leq T_a \leq 55^{\circ}\text{C}$
Supply voltage: max 30 VDC	T4: $-50 \leq T_a \leq 85^{\circ}\text{C}$ T5: $-50 \leq T_a \leq 75^{\circ}\text{C}$ T6: $-50 \leq T_a \leq 60^{\circ}\text{C}$

NI Installation instructions

- The transmitter must be installed in an enclosure providing a degree of protection of at least IP54 according to IEC60529 that is suitable for the application and is correctly installed. Cable entry devices and blanking elements shall fulfill the same requirements.
- If the enclosure is made of non-metallic materials or of painted metal, electrostatic charging shall be avoided.
- Use supply wires with a rating of at least 5 K above the ambient temperature.

WARNING: Substitution of components may impair suitability for Class I, Division 2
 AVERTISSEMENT: la substitution de composants peut nuire à l'aptitude à la Classe I, Division 2.

WARNING: Do not disconnect equipment unless power has been switched off or the area is known to be safe.

AVERTISSEMENT: Ne débranchez pas l'équipement sauf si l'alimentation a été coupée ou si la zone est connue pour être sûre.

Non Incendive field wiring installation

The non incendive field Wiring Circuit concept allows interconnection of Nonincendive Field wiring Apparatus with Associated Nonincendive Field Wiring Apparatus or Assosicated Intrinsically Safe Apparatus or Associated Apparatus not specially examined in combination as a syatem using any of the wiring methods permitted for unclassified locations, $V_{oc} < V_{max}$, $C_a \geq C_i + C_{cable}$, $L_a \geq L_i + L_{cable}$.

Terminal 11,12 and 21, 22 Non Incendive Field Wiring parameters	Temperature Range
$V_{max} = 30 \text{ VDC}$, $C_i = 1\text{nF}$, $L_i = 0$	T4: $-50 \leq T_a \leq 85^{\circ}\text{C}$ T5: $-50 \leq T_a \leq 75^{\circ}\text{C}$ T6: $-50 \leq T_a \leq 60^{\circ}\text{C}$

Functional Ratings:

$U_{nom} \leq 30 \text{ VDC}$; $I_{nom} \leq 3.5 - 23 \text{ mA}$

Instalação INMETRO 6437QB01-V4R1

INMETRO Certificado DEKRA 23.0002X

Normas: **ABNT NBR IEC 60079-0:2020 Versão Corrigida:2023**
ABNT NBR IEC 60079-7:2018 Versão Corrigida:2022
ABNT NBR IEC 60079-11:2013 Versão Corrigida:2017

Para a instalação segura do 6431Dxxx e 6437Dxxx os seguintes pontos devem ser observados

NOTAS Ex ia IIC T6...T4 Ga or
 Ex ib [ia Ga] IIC T6...T4 Gb
 Ex ia IIIC Db
 Ex ia I Ma

Instalação Ex ia

Área Classificada
 Zone 0, 1, 2, 21, 22 and M1

Área Não classificada

Terminais:

54,53,52,51 e
 44,43,42,41

Uo: 7,2 VDC
 Io: 7,3 mA
 Po: 13,2 mW
 Lo: 667 mH
 Co: 13,5µF

Terminais:

44,43,42,41

Uo: 7,2 VDC
 Io: 7,3 mA
 Po: 13,2 mW
 Lo: 667 mH
 Co: 13,5µF

Terminais:

54,53,52,51

Uo: 7,2 VDC
 Io: 7,3 mA
 Po: 13,2 mW
 Lo: 667 mH
 Co: 13,5µF

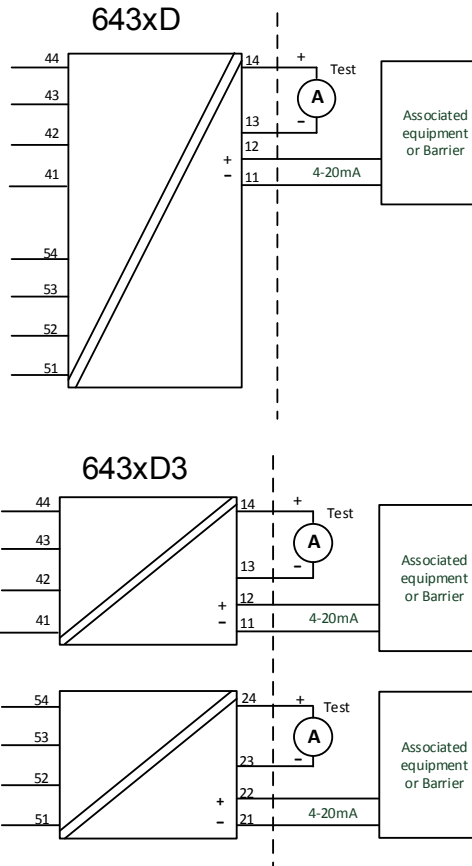

Instalação Ex ib

Área Classificada
Zone 0, 1, 2,
21, 22 and Ma

Área Classificada
Zone 1

Área Não Classificada

Terminais:
54,53,52,51 e
44,43,42,41

U_o: 7,2VDC
I_o: 7,3 mA
P_o: 13,2 mW
L_o: 667 mH
C_o: 13,5µF

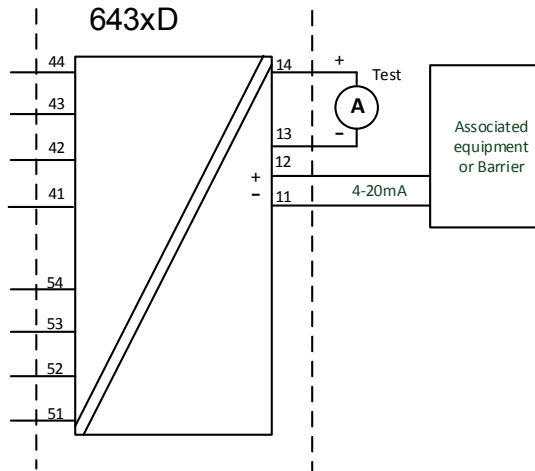

Terminais:
44,43,42,41

U_o: 7,2VDC
I_o: 7,3 mA
P_o: 13,2 mW
L_o: 667 mH
C_o: 13,5µF

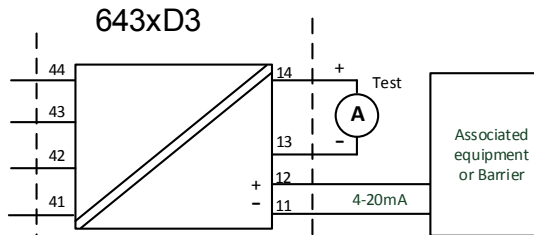

Terminais:
54,53,52,51

U_o: 7,2VDC
I_o: 7,3 mA
P_o: 13,2 mW
L_o: 667 mH
C_o: 13,5µF

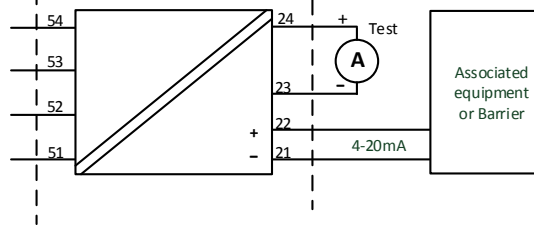

643xD1: Terminais: 11,12			
643xD2: Terminais: 11,12			
643xD3: Terminais: Ch1: 11,12 Ch2: 21,22			
Instalações Ex ia e Ex ib			
Ui: 30 VDC; li: 120 mA; Li: 0 µH; Ci: 1,0nF			
P _i por canal	Classe de temperatura	Faixas de Temperaturas	
		Entrada simples e dupla	Dois canais
900 mW	T6	+50 °C	+45 °C
	T5	+65 °C	+60 °C
	T4	+85 °C	+85 °C
750 mW	T6	+55 °C	+50 °C
	T5	+70 °C	+65 °C
	T4	+85 °C	+85 °C
610 mW	T6	+60 °C	+55 °C
	T5	+75 °C	+70 °C
	T4	+85 °C	+85 °C

Instruções Gerais de Instalação

O ano de fabricação pode ser obtido a partir dos dois primeiros dígitos do número de série. Se o invólucro for feito de materiais não metálicos ou de metal com uma camada de tinta mais espessa que 0,2 mm (grupo IIC) ou 2 mm (grupo IIB, IIA, I) ou qualquer espessura (grupo III), cargas eletrostáticas devem ser evitadas.

Para EPL Ga, se o invólucro for de alumínio, ele deverá ser instalado de forma que as fontes de ignição devido a faíscas de impacto e fricção sejam excluídas.

A distância entre os terminais, inclusive a parte nua dos fios, deve ser pelo menos 3 mm separada de qualquer metal aterrado.

Os pinos de teste permitem medir a corrente do loop diretamente, mantendo a integridade do loop. A energia deve estar conectada ao transmissor ao usar os pinos de teste. Para instalação em áreas classificadas, somente equipamentos de teste certificados podem ser utilizados.

Se o transmissor foi aplicado no tipo de proteção Ex ec, pode não ser aplicado posteriormente para segurança intrínseca.

O conector frontal e os pads de teste frontais fornecem um sinal de porta de extensão intrinsecamente seguro e só podem ser conectados a equipamentos dedicados da PRelectronics.

Aviso: Não conecte ou desconecte as fichas e as tomadas quando energizados.

Para instalação em uma atmosfera potencialmente explosiva de poeira, as seguintes instruções se aplicam:

O transmissor deve ser montado em um gabinete que ofereça um grau de proteção de pelo menos IP5X, de acordo com a ABNT NBR IEC60529. O gabinete deve ser adequado para a aplicação e instalado corretamente.

Os dispositivos de entrada de cabos e os elementos de supressão devem cumprir os mesmos requisitos.

A temperatura da superfície do invólucro externo é +20 K acima da temperatura ambiente, determinada sem camada de poeira.

Para instalações em Minas, as instruções abaixo se aplicam:

O transmissor deverá ser montado em um gabinete de metal que possibilita um grau mínimo de proteção IP54 de acordo com a ABNT NBR IEC60529

Gabinetes de Alumínio não são permitidos para instalações em Minas.

O gabinete deve ser adequado para a aplicação e instalado corretamente.

Os dispositivos de entrada de cabos e os elementos espaçadores devem satisfazer os mesmos requisitos

Instalações Ex ec / Ex ic

Para instalações seguras do 6431Axxx e 6437Axxx as seguintes instruções devem ser observadas

Notas Ex ec IIC T6...T4 Gc
Ex ic IIC T6...T4 Gc
Ex ic IIIC Dc

Área Classificada
Zone 2 and 22

Área Não Classificada

Terminais:

54,53,52,51 e
44,43,42,41

Uo: 7,2 VDC
Io: 7,3 mA
Po: 13,2 mW
Lo: 667 mH
Co: 13,5µF

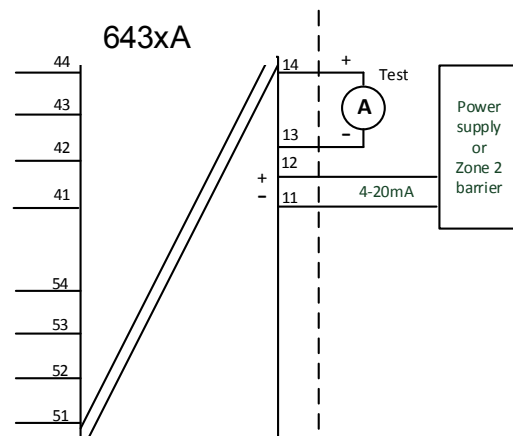

Terminais:

44,43,42,41

Uo: 7,2 VDC
Io: 7,3 mA
Po: 13,2 mW
Lo: 667 mH
Co: 13,5µF

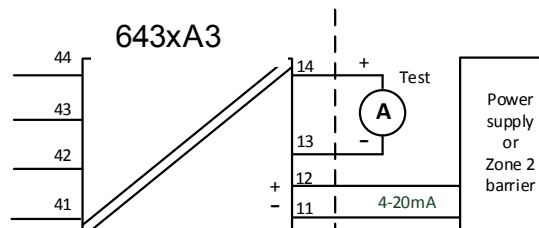

Terminais:

54,53,52,51

Uo: 7,2 VDC
Io: 7,3 mA
Po: 13,2 mW
Lo: 667 mH
Co: 135µF

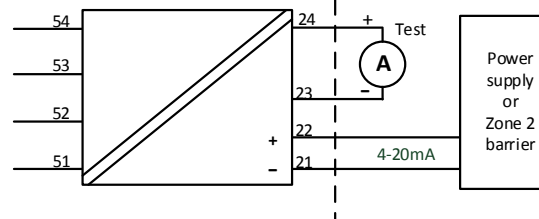

643xA1: Terminal 44 43,42,41	
643xA2: Terminal In1: 44 43,42,41	In2: 54 53,52,51
643xA3 : Terminal Ch1: 44 43,42,41	Ch2: 54 53,52,51
Ex ec	Ex ic
Vmax = 7,2VDC	Uo: 7,2 VDC; Io: 7,3 mA Po: 13,2 mW; Lo: 667 mH; Co: 13,5µF

643xA1: Terminais: 11,12					
643xA2: Terminais: 11,12					
643xA3: Terminais: Ch1: 11,12 Ch2: 21,22					
Circuito de alimentação / saída				Faixa de Temperatura	
Ex ec	Ex ic	Ex ic	Classe de temperatura	Entrada simples e dupla	Dois canais
	Li = 0 uH Ci = 1,0 nF	Ui= 48 VDC, Li = 0 uH, Ci = 1,0 nF			
Vmax= 37 VDC	Ui= 37 VDC	Pi= 851 mW por canal	T4	+85 °C	+85 °C
			T5	+70 °C	+65 °C
			T6	+55 °C	+50 °C
Vmax= 30 VDC	Ui= 30 VDC	Pi= 700 mW por canal	T4	+85 °C	+85 °C
			T5	+75 °C	+70 °C
			T6	+60 °C	+55 °C

Instruções gerais de instalação:

Se o invólucro for feito de materiais não metálicos, ou se for feito de metal com uma camada de tinta mais espessa que 0,2 mm (grupo IIC), ou 2 mm (grupo IIB, IIA, I) ou qualquer espessura (grupo III), cargas eletrostáticas devem ser evitadas.

Para uma temperatura ambiente $\geq 60^{\circ}\text{C}$, devem ser utilizados cabos resistentes ao calor com uma classificação de pelo menos 20 K acima da temperatura ambiente.

O gabinete deve ser adequado para a aplicação e instalado corretamente.

A distância entre terminais, fios inclusivos não isolados, deve ser separada por pelo menos 3 mm de qualquer metal aterrado.

A conexão TESTE, deve ser utilizado somente quando a área é segura, ou quando a fonte / circuito de saída e o medidor de corrente aplicado seja do tipo intrinsecamente seguro.

Aviso: Não conecte ou desconecte as fichas e as tomadas quando energizados.

Para instalações em uma atmosfera de gás potencialmente explosiva, as instruções abaixo e aplicação:

O transmissor deve ser instalado em um gabinete que forneça um grau de proteção não inferior a IP54, de acordo com a ABNT NBR IEC 60079-0, adequado para a aplicação e corretamente instalado, por exemplo, em um gabinete que esteja no tipo de proteção Ex ec.

Além disso, a área dentro do gabinete deve ter grau de poluição 2 ou melhor, conforme definido na ABNT NBR IEC 60664-1.

Os dispositivos de entrada de cabos e os elementos de supressão devem cumprir os mesmos requisitos.

Para a instalação em uma atmosfera de poeira potencialmente explosiva, as seguintes instruções se aplicam:

Para EPL Dc, a temperatura da superfície do invólucro externo é +20 K acima da temperatura ambiente, determinada sem camada de poeira.

Se o transmissor for fornecido com um sinal intrinsecamente seguro "ic" e fizer interface com um sinal intrinsecamente seguro "ic" (por exemplo, um dispositivo passivo), o transmissor deverá ser montado em um gabinete que forneça um grau de proteção de pelo menos IP54 de acordo com IEC 60079-0. Os dispositivos de entrada de cabos e os elementos de obturação devem cumprir os mesmos requisitos.

Se o transmissor for instalado em uma atmosfera explosiva que exija o uso de nível de proteção de equipamento Gc e aplicado no tipo de proteção Ex ec, o transmissor deverá ser montado em gabinete que forneça um grau de proteção de pelo menos IP54 de acordo com IEC 60079-0, e isso é adequado para o aplicativo e instalado corretamente. Os dispositivos de entrada de cabos e os elementos de obturação devem cumprir os mesmos requisitos.

Appendix A: Diagnostics overview

Incident Description	Description	LED reaction	Analog Output Reaction	NE-107 Class	User action	Error #
The device variable mapped to PV (and analog out put current) is beyond its operating limits.	Primary Value Out Of Limits	Flashing Red	Enters configured Value	Maintenance required	Reconnect or repair sensor	0
Any other device variable is beyond its operating limits.	Non-Primary Value Out Of Limits	Flashing Red	No impact	Maintenance required	Reconnect or repair sensor	1
The loop current has reached the Current Output Upper Limit (UL) or Output Lower Limit (LL) as configured with command #147, and is no longer corresponding to the PV value.	Loop Current Saturated	Flashing Red	Enters configured Value	Maintenance required	Reconnect or repair sensor	2
The analogue output current is being simulated or disabled.	Loop Current Fixed	Flashing Red	Enters configured Value	Function check	N.A.	3
The configuration has changed since this bit was last cleared (seen from same master type, Primary- or Secondary Master).	Configuration Changed	No Impact	No impact	N.A.	N.A.	6
A sensor error (broken/shorted sensor) is detected on Input 1	Primary Input 1 error	Flashing Red	Enters configured Value	Failure	Reconnect or repair sensor	10
A sensor error (broken/shorted sensor) is detected on Input 2. This is only possible if Input type 2 is <> "None"	Primary Input 2 error (only if Input 2 is enabled)	Flashing Red	Enters configured Value	Failure	Reconnect or repair sensor	11
A sensor error (broken/shorted sensor) is detected on the CJC measurement used for Input 1	CJC for Input 1 error (only if used)	Flashing Red	Enters configured Value	Failure	Reconnect or repair sensor	12
A sensor error (broken/shorted sensor) is detected on the CJC measurement used for Input 2	CJC for Input 2 error (only if used)	Flashing Red	Enters configured Value	Failure	Reconnect or repair sensor	13
The difference between measurements on Input 1 and Input 2 is outside the configured sensor drift limit	Dual Input: Sensor drift alarm (only if enabled)	Flashing Red	Enters configured Value	Failure	Reconnect or repair sensor	14
A sensor error (broken/shorted) is detected, backup sensor is in use	Dual Input: Backup sensor OK, main sensor error	No Impact	No impact	Maintenance required	Reconnect or repair sensor	15
A sensor error (broken/shorted) is detected on the backup sensor, no backup available	Dual Input: Backup sensor error, main sensor OK	No Impact	No impact	Maintenance required	Reconnect or repair sensor	16
Configuration is temporary invalid < 3 seconds, e.g. while downloading parameters	Configuration not supported by device	Flashing Red	Value is held (freeze)	Function check	N.A.	17
Configuration is temporary invalid > 3 seconds, e.g. if download is paused	Configuration not supported by device	Lights Red	Safe State	Failure	Correct and/or re-send the configuration	18
The device is operated outside its specified temperature range	Internal electronics temperature alarm	Flashing Red	No impact	Out of specification	Check operating temperature	19
The device is operated outside its specified temperature range in SIL mode	Internal electronics temperature alarm	Lights Red	Safe State	Failure	Check operating temperature	20
Power is applied but still too low	Minimum supply voltage not reached	Off	Safe State	Function check	Check power supply (at output terminals). If the error is persistant send in the device for repair	21
The device is transitioning to SIL mode, or have failed to do so	Attempting or failed to enter SIL mode	Lights Red	Safe State	Function check	The SIL configuration must be validated or normal operation must be re-selected	22
An unrecoverable error occurred in the internal communication to the Input CPU	Error in communication with Input CPU	Lights Red	Safe State	Failure	Reset or re-power the device. If the error is persistant send in the device for repair	23

Incident Description	Description	LED reaction	Analog Output Reaction	NE-107 Class	User action	Error #
An unrecoverable error occurred in the Input CPU	Input CPU reconfiguration failed	Lights Red	Safe State	Failure	Reset or re-power the device. If the error is persistent send in the device for repair	24
The device is operated below its specified voltage supply range	Supply voltage too low	Lights Red	Safe State	Failure	Check power supply (at output terminals). Reset or re-power the device. If the error is persistent send in the device for repair	25
The read back loop current differs from the calculated output current	Loop current read back error	Lights Red	Safe State	Failure	Check power supply (at output terminals). Reset or re-power the device. If the error is persistent send in the device for repair	26
The device is operated above its specified voltage supply range	Supply voltage too high	Lights Red	Safe State	Failure	Check power supply (at output terminals). Reset or re-power the device. If the error is persistent send in the device for repair	27
The configuration in the NVM has become inconsistent	Error in data verification after writing to EEPROM	Lights Red	Safe State	Failure	Correct and/or re-send the configuration. If the error is persistent send the device to repair	28
The configuration in the NVM has become inconsistent	CRC16 error in cyclic test of EEPROM	Lights Red	Safe State	Failure	Correct and/or re-send the configuration. If the error is persistent send the device to repair	29
An unrecoverable error occurred in the internal communication to the EEPROM	Error in EEPROM communication	Lights Red	Safe State	Failure	Reset or re-power the device. If the error is persistent send in the device for repair	30
An unrecoverable memory error occurred in the internal main CPU	CRC16 error in cyclic test of program code in FLASH	Lights Red	Safe State	Failure	Reset or re-power the device. If the error is persistent send in the device for repair	31
An exception error occurred in the main CPU program execution	Exception error during code execution	Lights Red	Safe State	Failure	Reset or re-power the device. If the error is persistent send in the device for repair	32
The main program was reset unintentionally due to a stuck up	Watchdog Reset Executed	Lights Red	Safe State	Failure	Correct and/or re-send the configuration. If the error is persistent send the device to repair	33
Sensor error is detected on the internal temperature sensor	Internal RTD sensor error	Lights Red	Safe State	Failure	Reset or re-power the device. If the error is persistent send in the device for repair	34
An unrecoverable memory error occurred in the internal main CPU	CRC16 error in cyclic test of safe-domain RAM contents	Lights Red	Safe State	Failure	Reset or re-power the device. If the error is persistent send in the device for repair	35
An exception error occurred in the main CPU program execution	Stack integrity error	Lights Red	Safe State	Failure	Reset or re-power the device. If the error is persistent send in the device for repair	36
An unrecoverable memory error occurred in the internal main CPU	CRC16 error in factory data in FLASH	Lights Red	Safe State	Failure	Reset or re-power the device. If the error is persistent send in the device for repair	37
An unrecoverable memory error occurred in the internal main CPU	RAM cell error	Lights Red	Safe State	Failure	Reset or re-power the device. If the error is persistent send in the device for repair	38
An unrecoverable memory error occurred in the internal main CPU	Safe domain RAM integrity error	Lights Red	Safe State	Failure	Reset or re-power the device. If the error is persistent send in the device for repair	39
An unrecoverable memory error occurred in the internal input CPU	CRC16 error in input CPU configuration	Lights Red	Safe State	Failure	Reset or re-power the device. If the error is persistent send in the device for repair	40

Incident Description	Description	LED reaction	Analog Output Reaction	NE-107 Class	User action	Error #
A critical measurement error is detected on internal voltage reference	Drift error, reference voltage FVR	Flashing Red	Safe State	Failure	Reconnect or repair sensor. If the error is persistent send in the device for repair	41
A critical measurement error is detected on internal voltage reference	Drift error, reference voltage VREF	Flashing Red	Safe State	Failure	Reconnect or repair sensor. If the error is persistent send in the device for repair	42
A critical measurement error is detected on Input 1	Drift error, primary Input 1	Flashing Red	Safe State	Failure	Reconnect or repair sensor. If the error is persistent send in the device for repair	43
A critical measurement error is detected on Input 2	Drift error, primary Input 2	Flashing Red	Safe State	Failure	Reconnect or repair sensor. If the error is persistent send in the device for repair	44
A critical measurement error is detected on the ground measurement	Drift error, ground voltage offset to terminal 3	Flashing Red	Safe State	Failure	Reconnect or repair sensor. If the error is persistent send in the device for repair	45
The device is in simulation mode and one or more of its Device Variables are not representative of the process	Device Variable Simulation Active	No Impact	No impact	N.A.	N.A.	46

Document history

The following list provides notes concerning revisions of this document.

Rev. ID	Date	Notes
100	2014	Initial release of the product.
101	2018	Accuracy table updated for TC and mV inputs. Accuracy calculations updated for TC examples.
102	2110	Options for 6437x3xx deleted.
103	2240	ATEX and IECEx installation drawings updated. UKCA added.
104	2506	INMETRO and NEPSI approvals updated - Ex nA replaced by Ex ec. Response time corrected from 70 ms to 75 ms.

We are near you, *all over the world*

Our trusted red boxes are supported wherever you are

All our devices are backed by expert service and a 5-year warranty. With each product you purchase, you receive personal technical support and guidance, day-to-day delivery, repair without charge within the warranty period and easily accessible documentation.

We are headquartered in Denmark, and have offices and authorized partners the world over. We are a local

business with a global reach. This means that we are always nearby and know your local markets well. We are committed to your satisfaction and provide PERFORMANCE MADE SMARTER all around the world.

For more information on our warranty program, or to meet with a sales representative in your region, visit prelectronics.com.

Benefit today from *PERFORMANCE MADE SMARTER*

PR electronics is the leading technology company specialized in making industrial process control safer, more reliable and more efficient. Since 1974, we have been dedicated to perfecting our core competence of innovating high precision technology with low power consumption. This dedication continues to set new standards for products communicating, monitoring and connecting our customers' process measurement points to their process control systems.

Our innovative, patented technologies are derived from our extensive R&D facilities and from having a great understanding of our customers' needs and processes. We are guided by principles of simplicity, focus, courage and excellence, enabling some of the world's greatest companies to achieve PERFORMANCE MADE SMARTER.