



ADVARSEL
Modulet må kun tilsluttes af kvalificerede teknikere, som er bekendte med de tekniske udtryk, advarsler og instruktioner i installationsvejledningen, og som vil følge disse.



WARNING
Only technicians, who are familiar with the technical terms, warnings, and instructions in the manual and who are able to follow these, should connect the device.



AVERTISSEMENT
Il est conseillé de réserver le raccordement du module aux techniciens qualifiés qui connaissent les termes techniques, les avertissements et les instructions de ce guide et qui sont capables d'appliquer ces derniers.



WARNUNG
Das Gerät darf nur von qualifizierten Technikern angeschlossen werden, die mit den technischen Ausdrücken, Warnungen und Anweisungen in dieser Installationsanleitung vertraut sind und diese befolgen.

Hvis der er tvivl om modulets rette håndtering, skal der rettes henvendelse til den lokale forhandler eller alternativt direkte til **PR electronics A/S**.

Should there be any doubt as to the correct handling of the device, please contact your local distributor or PR electronics A/S.

Installation og tilslutning af modulet skal følge landets gældende regler for installation af elektrisk materiel.

Mounting and connection of the device should comply with national legislation for mounting of electric materials.

Udsifting af komponenter kan forringe egenskaber.

Substitution of components may impair intrinsic safety.

Reparation af modulet må kun foretages af PR electronics A/S.

Repair of the device must be done by PR electronics A/S only.

Transmitterdækslet må ikke fjernes i eksplosionsfarligt område, når kredsløbet er strømførende.

Do not remove the transmitter cover in explosive atmospheres when the circuit is alive.

Transmitterdækslet skal være helt lukket for at overholde kravene til eksplosionsikring.

The transmitter cover must be fully engaged to meet the explosion proof requirements.

Hvis transmitteren er installeret i områder med kraftige vibrationer, kan det være nødvendigt med ekstra befæstning.

If installed under high-vibration conditions, the transmitter may require supplementary support.

Ved installation i eksplosionsfarligt område skal den tilhørende installationstegning følges nøje.

For installation in hazardous area the corresponding installation drawing must be followed in detail.

Vær opmærksom på ikke at frembringe mekaniske gnister, når instrumentet og tilhørende enheder tilgås i eksplosionsfarligt område.

Take care not to generate mechanical sparking when accessing the instrument and peripheral devices in a hazardous location.

Electrical specifications

Operating temperature with silicone O-ring..... -40°C to +85°C
with FKM O-ring..... -20°C to +85°C
Reduced LCD performance below -20°C and above +70°C
Storage temperature..... -40°C to +85°C
Calibration temperature..... 20...28°C
Relative humidity..... 0...100% RH (cond.)
Protection degree..... IP54 / IP66 / IP68 type 4X

Mechanical specifications:

Dimensions Ø 110 mm
Dimensions, H x W x D..... 109x145x125,5 mm
Weight approx..... 1,3 kg
Wire size..... 0.13...1,5 mm² / AWG 26...16 stranded wire
Screw terminal torque..... 0,4 Nm
Vibration IEC 60068-2-6 : 2007 2...25 Hz..... ±1,6 mm 25...100 Hz..... ±4 g

Common electrical specifications:

Supply voltage, DC Ex ia, intrinsically safe..... 10...30 VDC (12...30 VDC with backlight)
Other..... 10...35 VDC (12...35 VDC with backlight)
Isolation - test / working..... 1,5 kVAC / 50 VAC
Long term stability..... 0,1% of span / year

Input specifications:

RTD input types:
Pt50, Pt100, Pt200, Pt500, Pt1000, Ni50, Ni100, Ni120, Ni1000
Cable resistance per wire (max.)..... 5 Ω
Sensor current..... Nom. 0,2 mA

TC input types:

B, E, J, K, L, N, R, S, T, U, W3, W5, Lr

mV input:

Voltage input range..... -800...+800 mV
Min. span..... 2,5 mV
Input resistance..... 10 MΩ

Output specifications:

Signal range..... 4...20 mA
Min. signal range..... 1,6 mA
Load resistance..... ≤ (Vsupply - 10) / 0,023 [Ω]
with backlight..... ≤ (Vsupply - 12) / 0,023 [Ω]

Sensor error detection, programmable..... 3,5...23 mA
NAMUR NE43 Upscale..... 23 mA
NAMUR NE43 Downscale..... 3,5 mA
HART protocol revisions..... HART 7 and HART 5

Observed authority requirements:

EMC..... 2014/30/EU
ATEX..... 2014/34/EU
RoHS..... 2011/65/EU
EAC..... TR-CU 020/2011

Indgangsspecifikationer:

Indgang for RTD-typer:

Pt50, Pt100, Pt200, Pt500, Pt1000, Ni50, Ni100, Ni120, Ni1000

Kabelmodstand pr. leder (max.)..... 5 Ω

Falerstrøm..... Nom. 0,2 mA

Indgang for TC-typer:

B, E, J, K, L, N, R, S, T, U, W3, W5, Lr

mV-indgang:

Måleområde, spænding..... -800...+800 mV

Min. span..... 2,5 mV

Indgangsmodstand..... 10 MΩ

Strømodgang:

Signalområde..... 4...20 mA

Min. signalområde..... 1,6 mA

Belastningsmodstand..... ≤ (Vforsyn. - 10) / 0,023 [Ω]

med baggrundsbelysning. ≤ (Vforsyn. - 12) / 0,023 [Ω]

Falerfejlsdetektering:

programmerbar..... 3,5...23 mA

NAMUR NE43 Upscale..... 23 mA

NAMUR NE43 Downscale..... 3,5 mA

HART-protokolrevisorer..... HART 7 og HART 5

Overholdte myndighedskrav:

EMC..... 2014/30/EU

ATEX..... 2014/34/EU

RoHS..... 2011/65/EU

EAC..... TR-CU 020/2011

DK Indgangssignaler UK Input signals FR Signaux d'entrée DE Eingangssignale

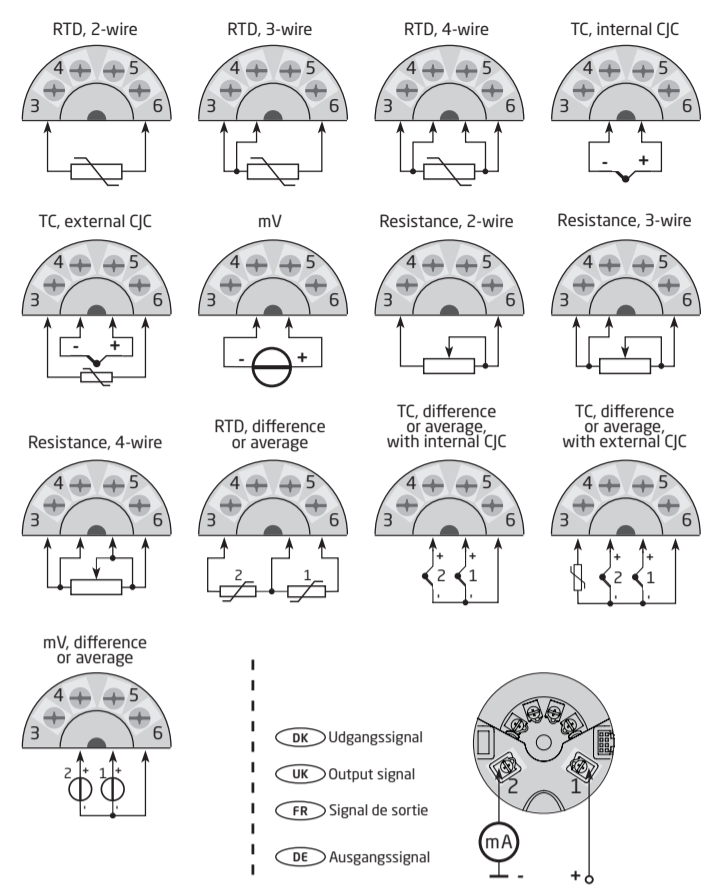

DK Konfiguration med HART modem og PReset PC konfigurationssoftware.

UK Configuration with a HART modem and the PReset software.

FR Programmation avec le modem HART et le logiciel PReset.

DE Programmierung mittels HART Modem und PReset PC Programmierungssoftware.

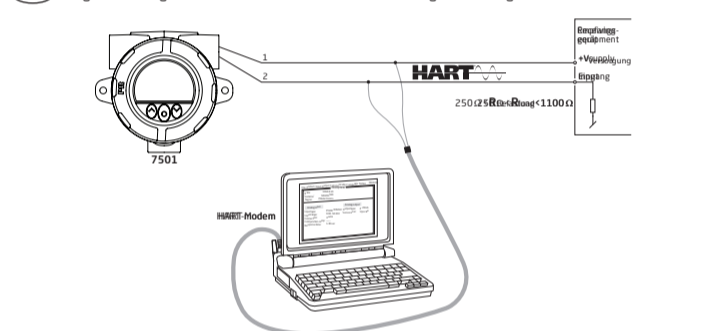

DK Konfiguration med HART kommunikator indeholdende 7501H5 eller 7501H7 DD driver.

UK Configuration with a HART compliant handheld communicator having the 7501H5 or 7501H7 DD driver installed.

FR Programmation avec le communicateur HART chargé avec le pilote DD 7501H5 ou 7501H7 DD.

DE Programmierung mittels HART Datenaustauschgerät mit 7501H5 oder 7501H7 DD-Antrieb.

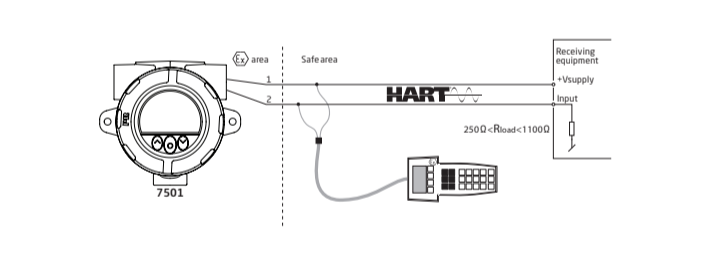

DK Sideskilt / mærkning UK Side label / marking FR Etiquette / marquage DE Typenschild / Markierung

PR electronics, Lerbakken 10, 8410 Roende, Denmark
pr@prelectronics.com MODEL: 7501xxxxxx
www.prelectronics.com SERIAL: 150812060
Phone +45 8637 2677 TAG:

Read manual/Lisez le manuel/Leia o manual Ex ia Ex ic Ex d Ex na Ex tb

IIHGEEx ia IICT6...T4G; IHDEx ia IIIC100°CDA; DEKRA15ATEX0058X
IIGEx d IICT6...T4 Gb; II 2 D Ex tb IIIC T100°CDB; IM1 Ex ia IMA
IIG Ex na IIC T6...T4G; IIG Ex ic IIC T6...T4 Gc; IECEX DEK15.0039X
IS CL I, II, III DIV1, GP ABCDEF; CL I, II, III DIV 2, GP ABCDFG; CL I, Zn 2, IIC
CL I, Zn 0 Ex/AEx ia IIC T6...T4 Gb; Zn 20 Ex/AEx ia IIC T80°C...T100°C Da
XP CL I, DIV1, GP ABCD, DIP CL II, DIV1, GP EFG, CL III
CL I, Zn 1, Ex/AEx d IIC T6 Ta=70°C, T4/T5 Ta=85°C Gb (-40°C/Tas85°C) Ex d
0344 Install: 7501QF01 7501QA01 7501QB01 7501QI01

CE, FM, ATEX, RoHS, EAC, IECEx, Ex ia, Ex ic, Ex d, Ex na, Ex tb

DK Godkendelser UK Approvals FR Approbations DE Zulassungen

DK Typennr.

UK Type no.

FR No. de type.

DE Typennr.

DK Produktionsår fremgår af de to første cifre i serienummeret.

UK Year of manufacture can be taken from the first two digits in the serial number.

FR L'année de production est définie grace aux deux premiers chiffres du numéro de série.

DE Die ersten beiden Ziffern der Seriennummer geben das Produktionsjahr an.

DK Når modulet installeres som Ex ia, ic, d, na eller tb, skal der på topskiltet sættes en kærnergrik til mærkning af den anvendte installationstype.

FR Lorsque ce produit a été installé comme Ex ia, ic, d, na ou tb, utiliser un poinçon à marquer dans la case appropriée pour indiquer le type d'installation sur l'étiquette.

UK When this product has been installed as Ex ia, ic, d, na or tb, use a punch marker in the appropriate box to indicate the type of installation on the top label.

DE Wenn dieses Produkt als Ex ia, ic, d, na oder tb installiert ist, nutzen Sie bitte die entsprechenden Felder auf dem Top-Label, um die Art der Installation zu kennzeichnen.

DK Mekaniske specifikationer UK Mechanical specifications FR Dimensions mécaniques

DE Abmessungen

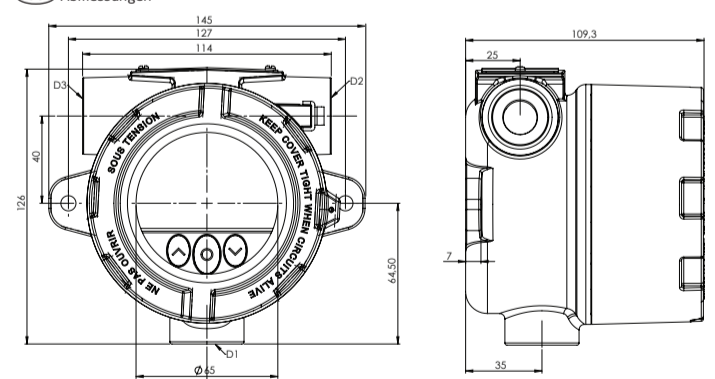

DK Godkendelser UK Approvals FR Approbations DE Zulassungen BR Aprovações

Product	ATEX	Area / Zone	Installation drawing	IECEx	Area / Zone	Installation drawing	INMETRO	Area / Zone	Installation drawing
7501xxxxx2	DEKRA 15ATEX0058 X	0, 1, 2, 20, 21, 22	7501QA01	DEK 15.0039 X	0, 1, 2, 20, 21, 22	7501QI01	DEKRA 15.0014 X	0, 1, 2, 20, 21, 22	7501QB01
Product	CSA	Zone / Div.	Installation drawing	FM	Zone / Div.	Installation drawing	NEPSI	EAC Ex	EU RO marine
7501xxxxx2	70024231	0, 1, 2 / Div. 1/2	7501QC01	3055380	0, 1, 2 / Div. 1/2	7501QF01	GY15.1336X GY15.1337X GY15.1338X	RU C DK.GB08.V.01316	MRA0000009
7501xxxxx1									MRA0000009

PR electronics A/S
Lerbakken 10
DK-8410 Rønde

Tel. +45 8637 2677
Fax +45 8637 3085
www.prelectronics.com

UK Documentation, permits and other information can be found on the internet at www.prelectronics.com

DE Dokumentationen, Zulassungen und andere Informationen können auf unserer Internet-Seite unter www.prelectronics.de gefunden und abgerufen werden.

DK Dokumentation, godkendelser og yderligere information findes på internettet på www.prelectronics.dk

FR La documentation et toute autre information peuvent être trouvées sur notre site: www.prelectronics.fr

BR Documentações, licenças e outras informações podem ser encontradas no site www.prelectronics.com

DK Rørmontage - ovenfra UK Pipe-mounting - top view FR Montage tuyauterie - vue de dessus DE Rohrmontage - Draufsicht

DK Vægmontage - ovenfra UK Wall-mounting - top view FR Montage mural - vue de dessus DE Wandmontage - Draufsicht

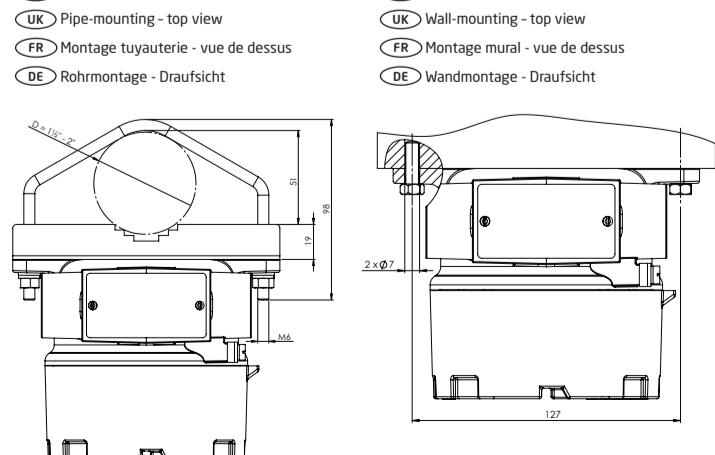

7501 ATEX Installation

! For safe installation of 7501 the following must be observed. The module shall only be installed by qualified personnel who are familiar with the national and international laws, directives and standards (EN60079-14) that apply to this area. Year of manufacture can be taken from the first two digits in the serial number.

Ex ia installation:

ATEX Certificate DEKRA 15ATEX0058 X

Marking **Ex** II 1 G Ex ia IIC T6...T4 Ga
 II 1 D Ex ia IIIC T100°C Da
 I M1 Ex ia I Ma (7501B)

Standards: EN 60079-0: 2012, EN 60079-11: 2012

Hazardous area
 Zone 0, 1, 2, 20, 21, 22, (Mines)

Non Hazardous Area

T4: -40 ≤ Ta ≤ 85°C T100 °C (7501A)
 T4: -40 ≤ Ta ≤ 80°C T100 °C (7501B)
 T5: -40 ≤ Ta ≤ 60°C T75 °C
 T6: -40 ≤ Ta ≤ 45°C T80 °C

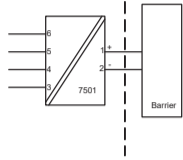

Sensor Terminal: 3,4,5,6
 Uo: 9.6 VDC
 Io: 28 mA
 Po: 67 mW
 Lo: 35 mH
 Co: 3.5 µF

Supply Terminal: 1,2
 Ui: 30 VDC
 Ii: 120 mA
 Pi: 0.84 W
 Li: 0 µH
 Ci: 2 nF

Revision date: 2015-11-03 Version Revision V2R0 Page: 1/6

Ex ia installation

General installation instructions
 The sensor circuit is not infallibly galvanic isolated from the supply output circuit. However, the galvanic isolation between the circuits is capable of withstanding a test voltage of 500Vac during 1 minute.

The enclosure must be connected to the potential matching line

If the transmitter is physically connected to a possible source of heating or cooling, e.g. by mounting to a process pipe or a temperature sensor, the temperature at the point of connection shall be within the ambient temperature range as given in the certificate or this manual.

Cable entries and blanking elements shall be used that are suitable for the application and correctly installed.

For installation of 7501A in zone 0 / EPL Ga, the transmitter must be installed such, that even in the event of rare incidents, ignition sources due to impact and friction, sparks are excluded.

Protection degree of IP 54 according to EN 60529 is achieved if certified cable glands or conduit entry devices are used that are suitable for the application and correctly installed.

Protection degree of IP 68 according to EN 60529 is only achieved if certified cable glands or conduit entry devices are used that are suitable for the application and correctly installed with sealing washers or Loctite sealant added to the threads of the sensor, blanking elements and cable glands.

For group III (dust), electrostatic charging of the paint layer shall be avoided

Revision date: 2015-11-03 Version Revision V2R0 Page: 2/6

Ex nA, ic installation:

Certificate DEKRA 15ATEX0058 X

Marking **Ex** II 3 G Ex nA IIC T6...T4 Gc
 II 3 G Ex ic IIC T6...T4 Gc
 II 3 D Ex ic IIIC T100°C Dc

Standards: EN 60079-0:2012, EN 60079-11:2012, EN60079-15:2010

Type of protection Ex nA **Type of protection Ex ic**

O-ring Sealing : Silicone
 T4: -40 ≤ Ta ≤ 85°C T4 (7501A)
 T4: -40 ≤ Ta ≤ 80°C T4 (7501B)
 T6: -40 ≤ Ta ≤ 60°C T6

T4: -40 ≤ Ta ≤ 85°C T100°C (7501A)
 T4: -40 ≤ Ta ≤ 80°C T100°C (7501B)
 T6: -40 ≤ Ta ≤ 60°C T85 °C

O-ring Sealing : FKM
 T4: -20 ≤ Ta ≤ 85°C (7501A)
 T4: -20 ≤ Ta ≤ 80°C (7501B)
 T6: -20 ≤ Ta ≤ 60°C

Hazardous area
 Zone 2, 22

Non Hazardous Area

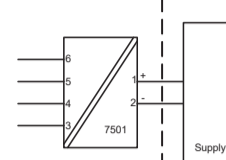

Sensor Terminal: 3,4,5,6
Ex ic
 Uo: 9.6 VDC
 Io: 28 mA
 Po: 67 mW
 Lo: 45 mH
 Co: 28 µF

Supply Terminal: 1,2
Ex ic
 Ui: 35 VDC
 Ii: 0 µH
 Ci: 2 nF

Supply Terminal: 1,2
Ex nA
 U : 35 VDC

Revision date: 2015-11-03 Version Revision V2R0 Page: 3/6

Ex nA, ic installation:

For an ambient temperature exceeding 70 °C, heat resistant cables and cable glands suitable for at least 90°C shall be used.

If the transmitter is physically connected to a possible source of heating or cooling, e.g. by mounting to a process pipe or a temperature sensor, the temperature at the point of connection shall be within the ambient temperature range as given in the certificate.

Cable entries and blanking elements shall be used that are suitable for the application and correctly installed.

The enclosure must be connected to the potential matching line

Applied screw terminal torque is max 0.4 Nm on all terminals.

Protection degree of IP 54 according to EN 60529 is achieved if certified cable glands or conduit entry devices are used that are suitable for the application and correctly installed.

Protection degree of IP 68 according to EN 60529 is only achieved if certified cable glands or conduit entry devices are used that are suitable for the application and correctly installed with sealing washers or Loctite sealant added to the threads of the sensor, blanking elements and cable glands.

For group III (dust), electrostatic charging of the paint layer shall be avoided

Ex d, tb installation:

ATEX Certificate DEKRA 15ATEX0058 X

Marking **Ex** II 2 G Ex d IIC T6...T4 Gb
 II 2 D Ex tb IIIC T100°C Db

Standards: EN 60079-0:2012, EN 60079-1:2007, EN60079-31:2014

Type of protection Ex d

T4,T5: -40 ≤ Ta ≤ 85°C (7501A)
 T4,T5: -40 ≤ Ta ≤ 80°C (7501B)
 T6: -40 ≤ Ta ≤ 70°C

Type of protection Ex tb

O-ring Sealing : Silicone
 -40 ≤ Ta ≤ 85°C T100°C (7501A)
 -40 ≤ Ta ≤ 80°C T100°C (7501B)
 -40 ≤ Ta ≤ 70°C T85 °C

O-ring Sealing : FKM
 -20 ≤ Ta ≤ 85°C T100°C (7501A)
 -20 ≤ Ta ≤ 80°C T100°C (7501B)
 -20 ≤ Ta ≤ 70°C T85 °C

Hazardous area
 Zone 1, 2, 21, 22

Non Hazardous Area

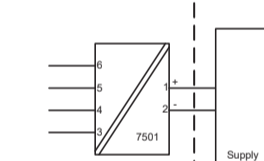

Terminal: 3,4,5,6
 Sensor: RTD or TC

Terminal: 1,2
 Umax: 35 VDC

Revision date: 2015-11-03 Version Revision V2R0 Page: 5/6

Ex d, tb installation:

The transmitter is intended, either to be connected via a cable, or to be mounted directly onto a temperature sensing probe. Only ATEX/IECEx equipment certified sensors, suitable for the application and correctly installed, may be mounted directly onto the Transmitter without additional certification of the combination.

If the transmitter is physically connected to a possible source of heating or cooling, e.g. by mounting to a process pipe or a temperature sensor, the temperature at the point of connection shall be within the ambient temperature range as given in the certificate. The sensor shall be suitable for use as entry device on an Ex d enclosure and shall not add volume to the 7501 enclosure. The thread of the sensor must be in compliance with EN60079-1 / EN60079-31.

Unused cable entries must be sealed by the blanking elements 8550-xxx and 8551-xxx supplied with the 7501 or other Ex d and/or Ex tb certified blanking elements suitable for the application. .

Only Ex d and/or Ex tb certified cable and cable glands shall be used that are suitable for the application and correctly installed.

Protection degree of IP 54 according to EN 60529 is achieved if Ex d certified cable glands or conduit entry devices are used that are suitable for the application and correctly installed.

Protection degree of IP 68 according to EN 60529 is only achieved if Ex d certified cable glands or conduit entry devices are used that are suitable for the application and correctly installed with sealing washers or Loctite sealant added to the threads of the sensor, blanking elements and cable glands.

The display cover must be screwed all the way in and the safety catch must be fastened before putting into service. Do not open display cover until 30 minutes after disconnecting power to the equipment allowing internal capacitors to discharge, or do not open display cover unless area is known to be safe

For an ambient temperature exceeding 70 °C, heat resistant cables and cable glands suitable for at least 90°C shall be used.

The enclosure must be connected to the potential matching line.

When the process temperature range exceeds the service temperature range it shall be verified by on-site temperature measurements, taking the worst case conditions into account, that the service temperature does not exceed the range of the module.

For group III (dust), electrostatic charging of the paint layer shall be avoided

No modification to the enclosure is allowed by the customer except as mentioned in the manual or installation drawing.

Revision date: 2015-11-03 Version Revision V2R0 Page: 6/6

7501 CSA Installation

! For safe installation of 7501 the following must be observed. The module shall only be installed by qualified personnel who are familiar with the national and international laws, directives and standards that apply to this area.

Intrinsic Safe Installation / SÉCURITÉ INTRINSÈQUE , Exia
 Applicable for (7501A.... and 7501B....).

Hazardous classified Location
 Class I, Division 1, Groups, ABCD;
 Class II, Group EFG;
 Class III, Division 1,
 Class I, Zone 0, IIC
 Ex/Ex ia IIC Ga

Non classified Location

T4: -40 ≤ Ta ≤ 85°C T100 °C (7501A)
 T4: -40 ≤ Ta ≤ 80°C T100 °C (7501B)
 T5: -40 ≤ Ta ≤ 60°C T75 °C
 T6: -40 ≤ Ta ≤ 45°C T80 °C

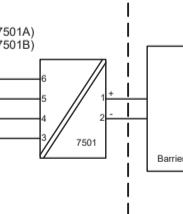

Terminal: 3,4,5,6
 Uo: 9.6 VDC
 Io: 28 mA
 Po: 67 mW
 Lo: 35 mH
 Co: 3.5 µF

Terminal: 1,2
 Ui: 30 VDC
 Ii: 120 mA
 Pi: 0.84 W
 Li: 0 µH
 Ci: 2 nF

UM < 250V
 Voc or Uo < Vmax or Ui
 Isc or Io < Imax or Ii
 Po < Pi
 Ca or Co > Ci + Ccable
 La or Lo > Li + Lcable

Warning
 Substitution of components may impair intrinsic safety.

AVERTISSEMENT
 LA SUBSTITUTION DE COMPOSANTS PEUT COMPROMETTRE LA SÉCURITÉ INTRINSÈQUE

The module must be installed according to the installation codes stipulated in the Canadian Electrical Code (CEC) or for US the National Electrical Code (NEC).

Revision date: 2015-11-03 Version Revision V3R0 Page: 1/3

Explosion proof / Dust ignition proof installation:
 Applicable for (7501A)

Explosion proof for Hazardous area
 Class I, Division 1, Groups ABCD;
 Class II, Division 1, Groups EFG;
 Class III
 Ex d IIC, Class I, Zone 1

Non Hazardous Area

T4,T5: -20/-40 ≤ Ta ≤ 85°C T100°C
 T6: -20/-40 ≤ Ta ≤ 70°C T85°C

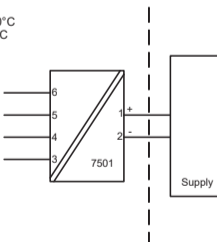

Terminal: 3,4,5,6
 Sensor: RTD or TC

Terminal: 1,2
 Umax: 35 VDC

O-ring Sealing
 Silicone rubber: -40°C ≤ Ta ≤ +85°C
 FKM rubber: -20°C ≤ Ta ≤ +85°C

Revision date: 2015-11-03 Version Revision V3R0 Page: 2/3

Explosion proof / Dust ignition proof installation:
 Applicable for (7501A)

Conduit and sensor connections must be in NPT modified threads.

Only third party certified sensors suitable for Class I, Division 1, Groups ABCDEFG or Class I, Zone 1 IIC may be attached to the Temperature Transmitter without additional approval of the combination.

For Class I Group A installation and Class I Zone 1 installation, conduit seal is required within 18 inches of enclosure.

For an ambient temperature exceeding 70°C, heat resistant cables and cables suitable for at least 90°C shall be used.

The display cover must be screwed all the way in and the safety catch must be fastened before putting the module into service. Do not open / remove front cover unless area is known to be safe.

The remote temperature sensor must comply with the requirements for installation in hazardous locations "Class I, Division 1 / Zone 1, Groups ABCD / IIC"

The remote temperature sensor must comply with the requirements for Ex d installation

Only certified cable and cable glands shall be used that are suitable for the application and correctly installed.

For protection according to Type 4X / IP66 use Loctite 577 on threads of sensor and cable glands.

The enclosure must be connected to the potential matching line

Unused cable entries must be sealed by the blanking elements supplied with the 7501 or other Ex certified blanking elements.

If the transmitter is physically connected to a possible source of heating or cooling, e.g. by mounting to a process pipe or a temperature sensor, the temperature at the point of connection shall be within the ambient temperature range as given in the certificate.

When the process temperature range exceeds the service temperature range it shall be verified by on-site temperature measurements, taking the worst case conditions into account, that the service temperature does not exceed the range of the module.

For Class II, III, electrostatic charging of the paint layer shall be avoided.

No modification to the enclosure is allowed by the customer except as mentioned in the manual or installation drawing.

Revision date: 2015-11-03 Version Revision V3R0 Page: 3/3

7501 IECEx Installation



For safe installation of 7501 the following must be observed. The module shall only be installed by qualified personnel who are familiar with the national and international laws, directives and standards (IEC60079-14) that apply to this area. Year of manufacture can be taken from the first two digits in the serial number.

Ex ia installation:

Certificate IECEx DEK 15.0039 X
 Marking Ex ia IIC T6...T4 Ga
 Ex ia IIIC T100°C Da
 Ex ia I Ma (7501B)

Standards: IEC 60079-0: 2011, IEC 60079-11: 2011, IEC 60079-26: 2007

Hazardous area
 Zone 0, 1, 2, 20, 21, 22, Mines

T4: -40 ≤ Ta ≤ 85°C T100°C (7501A)
 T4: -40 ≤ Ta ≤ 80°C T100°C (7501B)
 T5: -40 ≤ Ta ≤ 60°C T75°C
 T6: -40 ≤ Ta ≤ 45°C T80°C

Non Hazardous Area

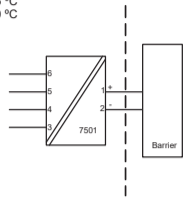

Sensor Terminal: 3,4,5,6
 Uo: 9.6 VDC
 Io: 28 mA
 Po: 67 mW
 Lo: 35 mH
 Co: 3.5 µF

Supply Terminal: 1,2
 Ui: 30 VDC
 Ii: 120 mA
 Pi: 0.84 W
 Li: 0 µH
 Ci: 2 nF

Ex ia installation

General installation instructions
 The sensor circuit is not infallibly galvanic isolated from the supply output circuit. However, the galvanic isolation between the circuits is capable of withstanding a test voltage of 500Vac during 1 minute.

The enclosure must be connected to the potential matching line.

If the transmitter is physically connected to a possible source of heating or cooling, e.g. by mounting to a process pipe or a temperature sensor, the temperature at the point of connection shall be within the ambient temperature range as given in the certificate or in this manual.

Cable entries and blanking elements shall be used that are suitable for the application and correctly installed.

For installation of 7501A in zone 0 / EPL Ga, the transmitter must be installed such, that even in the event of rare incidents, ignition sources due to impact and friction, sparks are excluded.

Protection degree of IP 54 according to IEC 60529 is achieved if certified cable glands or conduit entry devices are used that are suitable for the application and correctly installed.

Protection degree of IP 68 according to IEC 60529 is only achieved if certified cable glands or conduit entry devices are used that are suitable for the application and correctly installed with sealing washers or Loctite sealant added to the threads of the sensor, blanking elements and cable glands.

For group III (dust), electrostatic charging of the paint layer shall be avoided.

Ex nA, ic installation:

Certificate IECEx DEK 15.0039 X
 Marking Ex nA IIC T6...T4 Gc
 Ex ic IIC T6...T4 Gc
 Ex ic IIIC T100°C Dc

Standards: IEC 60079-0: 2011, IEC 60079-11: 2011, IEC 60079-15: 2010

Type of protection Ex nA

O-ring Sealing : Silicone
 T4: -40 ≤ Ta ≤ 85°C T4 (7501A)
 T4: -40 ≤ Ta ≤ 80°C T4 (7501B)
 T6: -40 ≤ Ta ≤ 60°C T6

Type of protection Ex ic

T4: -40 ≤ Ta ≤ 85°C T100°C (7501A)
 T4: -40 ≤ Ta ≤ 80°C T100°C (7501B)
 T6: -40 ≤ Ta ≤ 60°C T85°C

O-ring Sealing : FKM
 T4: -20 ≤ Ta ≤ 85°C (7501A)
 T4: -20 ≤ Ta ≤ 80°C (7501B)
 T6: -20 ≤ Ta ≤ 60°C

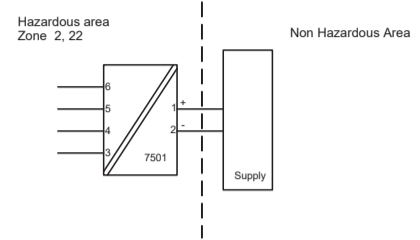

Sensor Terminal: 3,4,5,6
 Uo: 9.6 VDC
 Io: 28 mA
 Po: 67 mW
 Lo: 45 mH
 Co: 28 µF

Supply Terminal: 1,2
 Ui: 35 VDC
 Ii: 0 µH
 Ci: 2 nF

Supply Terminal: 1,2
 Umax : 35 VDC

Ex nA, ic installation:

For an ambient temperature exceeding 70°C, heat resistant cables and cable glands suitable for at least 90°C shall be used.

If the transmitter is physically connected to a possible source of heating or cooling, e.g. by mounting to a process pipe or a temperature sensor, the temperature at the point of connection shall be within the ambient temperature range as given in the certificate.

Cable entries and blanking elements shall be used that are suitable for the application and correctly installed.

The enclosure must be connected to the potential matching line

Applied screw terminal torque is max 0.4 Nm on all terminals.

Protection degree of IP 54 according to EN 60529 is achieved if certified cable glands or conduit entry devices are used that are suitable for the application and correctly installed.

Protection degree of IP 68 according to EN 60529 is only achieved if certified cable glands or conduit entry devices are used that are suitable for the application and correctly installed with sealing washers or Loctite sealant added to the threads of the sensor, blanking elements and cable glands.

For group III (dust), electrostatic charging of the paint layer shall be avoided

Ex d, tb installation:

Certificate IEC DEK 15.0039 X
 Marking Ex d IIC T6...T4 Gb
 Ex tb IIIC T100°C Db

Standards: IEC 60079-0: 2011, IEC 60079-1: 2007, IEC 60079-31: 2013

Type of protection Ex d

T4, T5: -40 ≤ Ta ≤ 85°C (7501A)
 T4, T5: -40 ≤ Ta ≤ 80°C (7501B)
 T6: -40 ≤ Ta ≤ 70°C

Type of protection Ex tb

O-ring Sealing : Silicone
 -40 ≤ Ta ≤ 85°C T100°C (7501A)
 -40 ≤ Ta ≤ 80°C T100°C (7501B)
 -40 ≤ Ta ≤ 70°C T85°C

O-ring Sealing : FKM
 -20 ≤ Ta ≤ 85°C T100°C (7501A)
 -20 ≤ Ta ≤ 80°C T100°C (7501B)
 -20 ≤ Ta ≤ 70°C T85°C

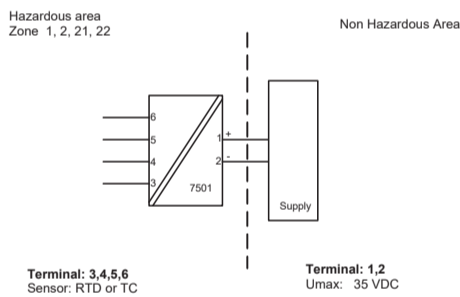

Terminal: 3,4,5,6
 Sensor: RTD or TC

Terminal: 1,2
 Umax: 35 VDC

Ex d, tb installation

The transmitter is intended, either to be connected via a cable, or to be mounted directly onto a temperature sensing probe. Only IECEx equipment certified sensors, suitable for the application and correctly installed, may be mounted directly onto the Transmitter without additional certification of the combination.

If the transmitter is physically connected to a possible source of heating or cooling, e.g. by mounting to a process pipe or a temperature sensor, the temperature at the point of connection shall be within the ambient temperature range as given in the certificate. The sensor shall be suitable for use as entry device on an Ex d enclosure and shall not add volume to the 7501 enclosure. The thread of the sensor must be in compliance with IEC60079-1/IEC60079-31

Unused cable entries must be sealed by the blanking elements 8550-xxx and 8551-xxx supplied with the 7501 or other Ex d and/or Ex tb certified blanking elements suitable for the application.

Only Ex d and/or Ex tb certified cable and cable glands shall be used that are suitable for the application and correctly installed.

Protection degree of IP 54 according to IEC 60529 is achieved if Ex d certified cable glands or conduit entry devices are used that are suitable for the application and correctly installed.

Protection degree of IP 68 according to IEC 60529 is only achieved if Ex d certified cable glands or conduit entry devices are used that are suitable for the application and correctly installed with sealing washers or Loctite sealant added to the threads of the sensor, blanking elements and cable glands.

The display cover must be screwed all the way in and the safety catch must be fastened before putting into service. Do not open display cover until 30 minutes after disconnecting power to the equipment allowing internal capacitors to discharge, or do not open display cover unless area is known to be safe

For an ambient temperature exceeding 70 °C, heat resistant cables and cable glands suitable for at least 90°C shall be used.

The enclosure must be connected to the potential matching line.

When the process temperature range exceeds the service temperature range it shall be verified by on-site temperature measurements, taking the worst case conditions into account, that the service temperature does not exceed the range of the module.

For group III (dust), electrostatic charging of the paint layer shall be avoided

No modification to the enclosure is allowed by the customer except as mentioned in the manual or installation drawing.

FM Installation drawing 7501



For safe installation of 7501 the following must be observed. The module shall only be installed by qualified personnel who are familiar with the national and international laws, directives and standards that apply to this area.

Intrinsic safe installation:

Hazardous classified Location
 Class I, II, III, Division 1 Groups, ABCDEFG
 Class I, Zone 0, IIC, Zone 20

Non classified Location

T4: -40 ≤ Ta ≤ 85°C (7501A)
 T4: -40 ≤ Ta ≤ 80°C (7501B)
 T5: -40 ≤ Ta ≤ 60°C
 T6: -40 ≤ Ta ≤ 40°C

Zone 20 Temperature Class:
 -40 ≤ Ta ≤ 85°C T100°C (7501A)
 -40 ≤ Ta ≤ 80°C T100°C (7501B)
 -40 ≤ Ta ≤ 60°C T75°C
 -40 ≤ Ta ≤ 40°C T60°C

Terminal: 1,2
 Ui: 30 VDC
 Ii: 120 mA
 Pi: 0.84 W
 Li: 0 µH
 Ci: 2 nF

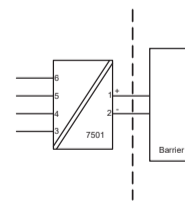

The barrier must not be connected to any associated apparatus which uses or generates more than 250 VRMS

Terminal: 3,4,5,6
 Uo: 9.6 VDC
 Io: 28 mA
 Po: 67 mW
 Lo: 35 mH
 Co: 3.5 µF

UM < 250V
 Voc or Uo < Vmax or Ui
 Isc or Io < Imax or Ii
 Po < Pi
 Ca or Co > Ci + Ccable
 La or Lo > Li + Lcable

The entity concept

The Transmitter must be installed according to National Electrical Code (ANSI-NFPA 70) and shall be installed with the enclosure, mounting, and spacing segregation requirement of the ultimate application.

Equipment that is FM-approved for intrinsic safety may be connected to barriers based on the ENTITY CONCEPT. This concept permits interconnection of approved transmitters, meters and other devices in combinations which have not been specifically examined by FM, provided that the agency's criteria are met. The combination is then intrinsically safe, if the entity concept is acceptable to the authority having jurisdiction over the installation.

The entity concept criteria are as follows:

The intrinsically safe devices, other than barriers, must not be a source of power. The maximum voltage Ui(Vmax) and current Ii(Imax), and maximum power Pi(Pmax), which the device can receive and remain intrinsically safe, must be equal to or greater than the voltage (Uo or Voc or Vi) and current (Io or Isc or Ii) and the power Po which can be delivered by the barrier.

The sum of the maximum unprotected capacitance (C) for each intrinsically device and the interconnecting wiring must be less than the capacitance (Ca) which can be safely connected to the barrier.

The sum of the maximum unprotected inductance (L) for each intrinsically device and the interconnecting wiring must be less than the inductance (La) which can be safely connected to the barrier.

The entity parameters Uo, Voc or Vi and Io, Isc or Ii, and Ca and La for barriers are provided by the barrier manufacturer.

For Class II and Class III installations where rigid conduit is not used, seal cable entries against dust and fibres using a NRTL listed cable gland fitting.

Non Incendive installation:

Applicable for (7501A and 7501B)

Hazardous classified Location
 Class I, II, III, Division 2, Groups, ABCDFG
 Class I, Zone 2, IIC

Non classified Location

T4: -20/-40 ≤ Ta ≤ 85°C (7501A)
 T4: -20/-40 ≤ Ta ≤ 80°C (7501B)
 T6: -20/-40 ≤ Ta ≤ 60°C

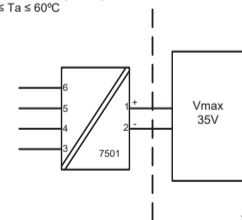

Terminal: 3,4,5,6
 Sensor: RTD or TC

Terminal: 1,2
 Vmax: 35 VDC

O-ring Sealings
 Silicone rubber: -40°C ≤ Ta ≤ +85°C
 FKM rubber: -20°C ≤ Ta ≤ +85°C

Protection: Indoor and Outdoor TYPE 4X or IP66

Explosion proof / Dust ignition proof installation
 Applicable for (7501A)

Hazardous area
 Class I, II, III Division 1, Groups ABCDEFG
 Class I Zone 1, Ex/AEx d IIC T6

Non Hazardous Area

T6: -20 / 40 ≤ Ta ≤ 70°C
 T5, T4: -20 / 40 ≤ Ta ≤ 85°C

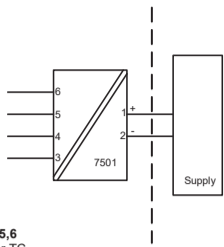

Terminal: 3,4,5,6
 Sensor: RTD or TC

Terminal: 1,2
 Umax: 35 VDC

O-ring Sealings
 Silicone rubber: -40°C ≤ Ta ≤ +85°C
 FKM rubber: -20°C ≤ Ta ≤ +85°C

Protection: Indoor and Outdoor Type 4X or IP66

Explosion proof / Dust ignition proof installation
 Applicable for (7501A)

The enclosure must be installed such, that even in the event of rare incidents, ignition sources due to impact and friction, sparks are excluded.

Unused cable entries must be sealed by approved sealing plugs.

Certified cable and cable glands shall be used that are suitable for the application and correctly installed or the cables must be run in conduit.

For an ambient temperature exceeding 70 °C, heat resistant cables and cable glands suitable for at least 90°C shall be used.

For process temperatures above 85°C or below -20/-40°C installer must verify by measurements that the service temperature of the 7501 module is held within this range taking worst conditions into account.

The display cover must be screwed all the way in and the safety catch must be fastened before operation.

Protection degree of IP 66 or TYPE4X, is only achieved if certified cable glands or conduit entry devices are used that are suitable for the application and correctly installed with sealing washers or Loctite sealant is added to the threads of the sensor, blanking elements and cable glands.

The enclosure must be connected to the potential matching line.

Warning:
 Do not open display cover unless area is known to be safe.

For installation in Canada the following must be taken into account:
 All openings for conduit and sensor connection must be in NPT threads.
 For Class I Group A installation, conduit seal is required within 18 inches of the enclosure.
 For Class I Zone I installation, conduit seal is required within 18 inches of the enclosure.

7501 Desenho de Instalação INMETRO



Para instalação segura do 7501 o seguinte deve ser observado. O módulo deve ser instalado, apenas por pessoas qualificadas as quais estão familiarizadas com as normas nacionais e internacionais, diretrizes e padrões (IEC60079-14) que se aplicam a esta área.

Instalação Segura do Ex ia installation:

Certificado DEKRA 15.0014X
 Marca Ex ia IIC T6...T4 Gc
 Ex ia IIC T100°C Da

Normas : ABNT NBR IEC 60079-0: 2013, ABNT NBR IEC 60079-11: 2013

Áreas Perigosas
 Zona 0, 1, 2, 20, 21, 22

Áreas não perigosas

T4: -40 ≤ Ta ≤ 85°C T100 °C (7501A)
 T4: -40 ≤ Ta ≤ 80°C T100 °C (7501B)
 T5: -40 ≤ Ta ≤ 60°C T100 °C
 T6: -40 ≤ Ta ≤ 45°C T100 °C

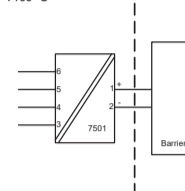

Terminal do sensor: 3,4,5,6
 Uo: 9.6 VDC
 Io: 28 mA
 Po: 67 mW
 Lo: 35 mH
 Co: 3.5 µF

Terminal de alimentação: 1,2
 Ui: 30 VDC
 li: 120 mA
 Pi: 0.84 W
 Li: 0 µH
 Ci: 2 nF

Instalação do Ex ia

Instruções de instalação gerais
 O circuito do sensor não é infalivelmente galvânico-isolado do circuito de saída de alimentação. Contudo, a isolamento galvânica entre os circuitos é capaz de resistir a teste de tensão de 500Vac durante 1 minuto.

O equipamento deve ser conectado à linha potencial correspondente

Se o transmissor estiver fisicamente conectado a uma possível fonte de calor ou resfriamento, por exemplo, através da montagem de um tubo de processo ou sensor de temperatura, a temperatura no ponto de conexão deve estar entre a faixa de temperatura ambiente determinada no certificado ou neste manual.

As entradas dos cabos e elementos de supressão devem ser usadas adequadamente para aplicação INMETRO, aprovada e instalada corretamente.

Para instalação 7501A em zona 0 / EPL Gc, se aplicam as seguintes instruções:
 O transmissor deve ser instalado de modo que, mesmo em um evento raro de incidente, fontes de ignição devido a impactos e fricção, faíscas sejam evitadas.

O grau de proteção do IP 54 de acordo com a IEC 60529 é alcançado se o certificado prensa-cabos ou dispositivos de entrada de condulte são usados e adequados para a aplicação e instalados corretamente.

O grau de proteção do IP 68 de acordo com a IEC 60529 é apenas alcançado se o certificado prensa-cabos ou dispositivos de entrada de condulte são usados e adequados para aplicação e instalados corretamente com selos de vedação ou selante Loctite adicionados para as linhas do sensor, elementos de supressão e prensa-cabos.

Cuidado
 Cuidados especiais devem ser tomados para evitar o acúmulo de carga eletrostática no equipamento devido ao repetitivo processo de carregamento, por exemplo, fluido de líquidos em alta velocidade, pós ou partículas de plásticos transportados pelo ar e outras cargas eletrostáticas para a superfície.

Instalação ic, Ex nA:

Certificado DEKRA 15.0014X
 Marca Ex nA IIC T6...T4 Gc
 Ex ic IIC T6...T4 Gc
 Ex ic IIC T100°C Dc

Normas : ABNT NBR IEC 60079-0: 2013, ABNT NBR IEC 60079-15: 2012

Ex nA

Anel de vedação O : Silicone
 T4: -40 ≤ Ta ≤ 85°C T4 (7501A)
 T4: -40 ≤ Ta ≤ 80°C T4 (7501B)
 T6: -40 ≤ Ta ≤ 60°C T6

Ex ic

T4: -40 ≤ Ta ≤ 85°C T100°C (7501A)
 T4: -40 ≤ Ta ≤ 80°C T100°C (7501B)
 T6: -40 ≤ Ta ≤ 60°C T85 °C

Anel de vedação O : FKM
 T4: -20 ≤ Ta ≤ 85°C (7501A)
 T4: -20 ≤ Ta ≤ 80°C (7501B)
 T6: -20 ≤ Ta ≤ 60°C

Áreas perigosas
 Zona 2, 22

Áreas não perigosas

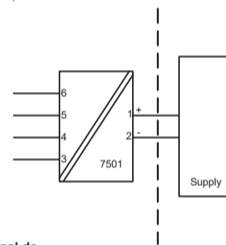

Terminal do sensor: 3,4,5,6
 Ex ic
 Uo: 9.6 VDC
 Io: 28 mA
 Po: 67 mW
 Lo: 45 mH
 Co: 28 µF

Terminal de alimentação: 1,2
 Ex ic
 Ui: 35 VDC
 Li: 0 µH
 Ci: 2 nF

Terminal de alimentação: 1,2
 Ex nA
 U : 35 VDC

Instalação icx, Ex nA:

Para uma temperatura ambiente excedendo 70 °C, cabos resistentes ao calor e prensa-cabos adequados para pelo menos 90 °C devem ser usados.

Se o transmissor estiver fisicamente conectado a uma possível fonte de calor ou resfriamento, por exemplo, através da montagem de um tubo de processo ou sensor de temperatura, a temperatura no ponto de conexão deve estar entre a faixa de temperatura ambiente determinada no certificado ou neste manual.

As entradas dos cabos e elementos de supressão devem ser usadas adequadamente para a aplicação e instaladas corretamente.

O equipamento deve ser conectado à linha potencial correspondente

O torque aplicado no terminal de parafusos é no máximo 0.4 Nm em todos os terminais.

O grau de proteção do IP 54 de acordo com a IEC 60529 é alcançado se o certificado prensa-cabos ou dispositivos de entrada de condulte são usados e adequados para a aplicação e instalados corretamente.

O grau de proteção do IP 68 de acordo com a IEC 60529 é apenas alcançado se o certificado prensa-cabos ou dispositivos de entrada de condulte são usados e adequados para aplicação e instalados corretamente com selos de vedação ou selante Loctite adicionados para as linhas do sensor, elementos de supressão e prensa-cabos.

Cuidado
 Cuidados especiais devem ser tomados para evitar o acúmulo de carga eletrostática no equipamento devido ao repetitivo processo de carregamento, por exemplo, fluido de líquidos em alta velocidade, pós ou partículas de plásticos transportados pelo ar e outras cargas eletrostáticas para a superfície

Instalação tb, Ex d:

Certificado DEKRA 15.0014X

Marca Ex d IIC T6...T4 Gb
 Ex tb IIC T100°C Db

Normas ABNT NBR IEC 60079-0: 2013, ABNT NBR IEC 60079-1: 2009,
 ABNT NBR IEC 60079-31:2014

Ex d

T4,T5: -40 ≤ Ta ≤ 85°C (7501A)
 T4,T5: -40 ≤ Ta ≤ 80°C (7501B)
 T6: -40 ≤ Ta ≤ 70°C

Ex tb

Anel de vedação O: Silicone
 -40 ≤ Ta ≤ 85°C T100°C (7501A)
 -40 ≤ Ta ≤ 80°C T100°C (7501B)
 -40 ≤ Ta ≤ 70°C T85°C

Anel de vedação O: FKM
 -20 ≤ Ta ≤ 85°C T100°C (7501A)
 -20 ≤ Ta ≤ 80°C T100°C (7501B)
 -20 ≤ Ta ≤ 70°C T85°C

Áreas perigosas
 Zona 1, 2, 21, 22

Áreas não perigosas

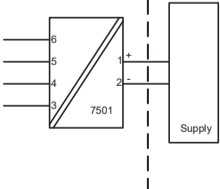

Terminal: 3,4,5,6
 Sensor: RTD ou TC

Terminal: 1,2
 Alimentação: 35 VDC

Instalação tb, Ex d:

O transmissor é destinado, quer para ser ligado através de um cabo, ou pode ser montado directamente sobre uma sonda de detecção de temperatura. Sensores apenas INMETRO certificadas, apropriadas para a aplicação e instalado corretamente, pode ser montado diretamente sobre o transmissor sem certificação adicional da combinação.

Se o transmissor estiver fisicamente conectado a uma possível fonte de calor ou resfriamento, por exemplo, através da montagem de um tubo de processo ou sensor de temperatura, a temperatura no ponto de conexão deve estar entre a faixa de temperatura ambiente dada no certificado. O sensor deve ser adequado para ser usado como entrada de equipamento no equipamento Ex d e nenhum volume deve ser adicionado no enclosure do 7501.

Entradas de cabos não utilizadas devem ser selados pelas elementos de bloqueio 8550-xxx-xxx e 8551 fornecidos com o 7501 ou seladas pelo INMETRO aprovou elementos adequados para a aplicação.

O Sensor / Sonda aplicado deve ser adequado para a aplicação, instalado corretamente, e deve ser certificado pelo INMETRO.

O grau de proteção do IP 54 de acordo com a IEC 60529 é alcançado se o certificado Ex de prensa-cabos ou dispositivos de entrada de condulte são usados e adequados para a aplicação e instalados corretamente.

O grau de proteção do IP 68 de acordo com a IEC 60529 é apenas alcançado se o certificado Ex de prensa-cabos ou dispositivos de entrada de condulte são usados e adequados para aplicação e instalados corretamente com selos de vedação ou selante Loctite adicionados para as linhas do sensor, elementos de supressão e prensa-cabos.

A tampa do display deve ser parafusada em todos os pontos e o fecho de segurança deve ser ajustado antes de colocá-lo em serviço. Não abra a tampa do display até 30 minutos depois de desconectar a alimentação a fim de permitir que os capacitores internos descarreguem, ou não abra a tampa do display a menos que a área seja conhecida como segura.

Para uma temperatura ambiente que excede 70 °C, cabos resistentes a aquecimento e prensa-cabos adequados para pelo menos 90 °C devem ser usados.

O equipamento deve ser conectado em uma linha potencial correspondente.

Quando a faixa de temperatura do processo excede a faixa de temperatura de serviço ela deve ser verificada através de medições de temperatura no local, levando a pior condição em conta, que a temperatura de serviço não exceda a faixa do módulo.

Cuidado
 Cuidados especiais devem ser tomados para evitar o acúmulo de carga eletrostática no equipamento devido ao repetitivo processo de carregamento, por exemplo, fluido de líquidos em alta velocidade, pós ou partículas de plásticos transportados pelo ar e outras cargas eletrostáticas para a superfície.

Nenhuma modificação no equipamento pelo cliente é permitida exceto o que é mencionado no manual ou no desenho de instalação.

DECLARATION OF CONFORMITY

(7501DOC_101)

As manufacturer

PR electronics A/S, Lerbakken 10, DK-8410 Rønde

hereby declares that the following product:

Type: 7501
Name: Field mounted HART temperature transmitter
From serial no: 154455001

is in conformity with the following directives and standards:

The EMC Directive and later amendments
 until 2016.04.19: 2004/108/EC
 from 2016.04.20: 2014/30/EU

EN 61326-1 : 2013

For specification of the acceptable EMC performance level, refer to the electrical specifications for the device.

The ATEX Directive and later amendments
 until 2016.04.19: 94/9/EC
 from 2016.04.20: 2014/34/EU

EN 60079-0:2012 + A11:2013, EN 60079-1:2007, EN 60079-11:2012,

EN60079-15:2010 and EN60079-31:2014

ATEX certificate: DEKRA 15 ATEX 0058 X (7501xxxxxx2)

Notified body (type approval)

DEKRA Certification B.V. (0344)

Meander 1051, 6825 MJ Arnhem

P.O. Box 5185, 6802 ED Arnhem

The Netherlands

The RoHS2 Directive 2011/65/EU

The product has been manufactured according to Directive 2011/65/EU on the restriction of the use of certain hazardous substances in electrical and electronic equipment.

Rønde, 29 September 2016

Stig Lindemann
 Stig Lindemann, CTO
 Manufacturer's signature